



Prepared for the General Services Administration  
By Pacific Northwest National Laboratory

December 2012

# Variable Refrigerant Flow Systems

Brian Thornton  
Anne Wagner

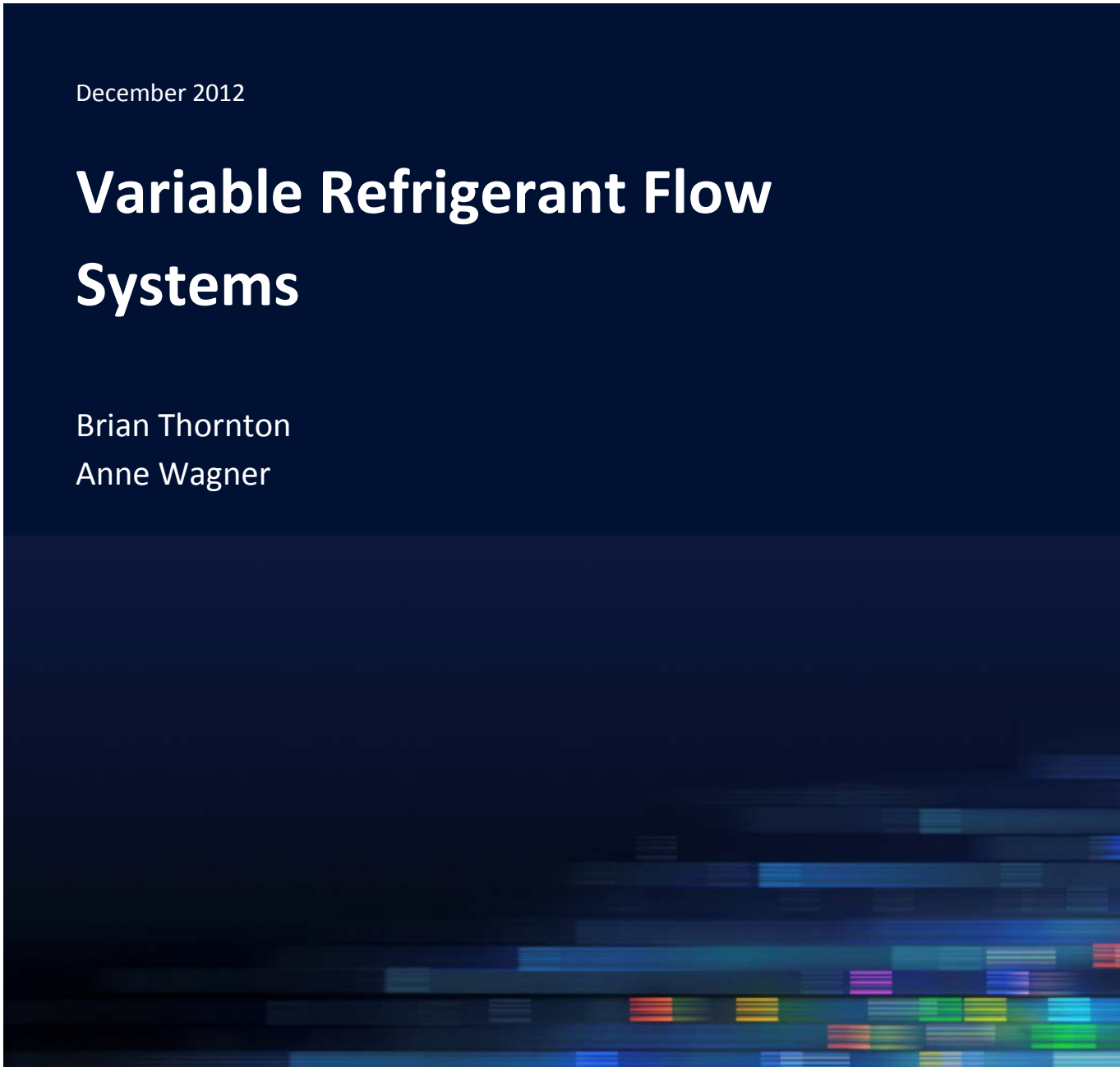



The Green Proving Ground program leverages GSA's real estate portfolio to evaluate innovative sustainable building technologies and practices. Findings are used to support the development of GSA performance specifications and inform decision-making within GSA, other federal agencies, and the real estate industry. The program aims to drive innovation in environmental performance in federal buildings and help lead market transformation through deployment of new technologies.

## DISCLAIMER

This document was prepared as an account of work sponsored by the United States Government. While this document is believed to contain correct information, neither the United States Government nor any agency thereof, nor the Pacific Northwest National Laboratory, nor Battelle Memorial Institute, nor any of their employees, makes any warranty, express or implied, or assumes any legal responsibility for the accuracy, completeness, or usefulness of any information, apparatus, product, or process disclosed, or represents that its use would not infringe privately owned rights. Reference herein to any specific commercial product, process, or service by its trade name, trademark, manufacturer, or otherwise, does not constitute or imply its endorsement, recommendation, or favoring by the United States Government or any agency thereof, or the Pacific Northwest National Laboratory, or Battelle Memorial Institute. The views and opinions of authors expressed herein do not necessarily state or reflect those of the United States Government or any agency thereof or the Pacific Northwest National Laboratory, or Battelle Memorial Institute. The work described in this report was funded by the U.S. General Services Administration under Contract No. PX0012922. The Pacific Northwest National Laboratory is a multi-disciplinary research laboratory operated for the U.S. Department of Energy by Battelle Memorial Institute under Contract Number DE-AC05-76RL01830.

## NO ENDORSEMENTS

Any hyperlink to any website or any reference to any third party website, entity, product, or service is provided only as a convenience and does not imply an endorsement or verification by Pacific Northwest National Laboratory of such website, entity, product, or service. Any access, use or engagement of, or other dealings with such website, entity, product, or service shall be solely at the user's own risk.

## ACKNOWLEDGEMENTS

United States General Services Administration (GSA): Kevin Powell, Zachary Hawks, Michael Hobson, Stefan Natzke, Waikit Kiu, Brian Wong, and Sarah Wenninger

Pacific Northwest National Laboratory: Brian Thornton, Anne Wagner, Kristen Alexander, Susan Arey, Nathan Bauman, Steven Parker, Marcus De La Rosa, and Lorena Ruiz

Bonneville Power Administration: Mira Vowles

For more information contact:

Kevin Powell  
Program Manager  
Green Proving Ground  
Office of the Commissioner  
Public Buildings Service  
U.S. General Services Administration  
555 Battery Street, Room 518  
San Francisco, CA 94111-2312  
Email: [kevin.powell@gsa.gov](mailto:kevin.powell@gsa.gov)

# Table of Contents

I.	Executive Summary .....	3
II.	Background .....	10
	A. Assessment.....	10
	B. Opportunity.....	10
III.	VRF Systems Technology .....	14
	A. VRF Equipment.....	14
	B. VRF System Efficiency .....	19
	C. Outdoor Air .....	21
	D. Merits and Limitations .....	22
	E. Ongoing Research .....	25
IV.	Project Examples .....	27
	A. Moakley U.S. Courthouse.....	27
	B. Other Project Examples.....	30
V.	Opportunity Assessment Results and Findings .....	32
	A. Project Economics .....	32
	B. Appropriate Applications .....	50
	C. Market Potential .....	51
	D. Barriers and Enablers .....	52
VI.	Summary Findings and Conclusions .....	55
	A. Overall Technology Assessment.....	55
	B. Best Practices .....	55
	C. Barriers to Adoption.....	57
	D. Market Potential Within GSA Portfolio.....	58
	E. Conclusion .....	58
VII.	Appendices .....	60
	A. References.....	60
	B. List of Abbreviations and acronyms .....	64
	C. Glossary .....	66

# I. Executive Summary

## BACKGROUND

Commercial buildings account for approximately 40% of the energy bills and 40% of the carbon dioxide emissions in the United States (USDOE 2012a). About a third of commercial building energy usage is for heating, cooling and ventilation (GSA 2012a).

The General Services Administration (GSA) is a leader among federal agencies in aggressively pursuing energy efficiency (EE) opportunities for its facilities and installing renewable energy (RE) systems to provide heating, cooling, and power to these facilities. Since the enactment of the Energy Policy Act of 2005 and Executive Order 13423, "Strengthening Federal Environmental, Energy, and Transportation Management (2007)," other federal agencies are looking to GSA for strategies for meeting the EE and RE goals laid out by these pieces of legislation and executive orders.

Variable refrigerant flow (VRF) heating, ventilation, and air conditioning (HVAC) systems are one possible tool to meet GSA's objectives. They are the primary HVAC system choice in Europe, Japan, China and other parts of the world, and are beginning to penetrate the U.S. market. VRF is particularly appropriate to existing buildings that use excessive energy or need HVAC repair and upgrade for other reasons.

## WHAT IS THE TECHNOLOGY?

VRF HVAC systems include two major parts, a compressor unit and multiple indoor fan coil units. The compressor unit, typically located on the roof, cools and heats refrigerant connected through piping to that condition the building.

The compressor units are typically air cooled. Sometimes water-cooled units are used and are connected to a cooling tower and boiler. In most installations in the United States, these systems are capable of simultaneously cooling some zones, and heating others. These systems can recover heat from spaces being cooled for use in spaces being heated and vice versa. The compressor unit is variable refrigerant flow and is controlled by a variable-speed drive, which may operate more efficiently than conventional compressors of similar size. The complexity of the variable refrigerant flow compressor and controls results in significantly more expensive compressor units than comparable conventional systems.

The fan coil units can be mounted directly in the space with a variety of configurations in the ceiling, walls or at the floor level. The fan coil units can also be hidden above the ceiling or other locations, near but not in, the conditioned space and be connected to the space through short air ducts. Fan coils condition and recirculate air from the space. There is no central air system with ductwork to provide the primary conditioning of the spaces, but there may be a smaller system to provide outside air.

Required outside air must be delivered to the space through another mechanism. This is usually done with a separate HVAC unit, commonly called a dedicated outside air system (DOAS). In most climates a cooling and heating source is required that conditions the air close to the room conditions and does not provide primary cooling or heating. These units often include energy recovery from the exhaust air to the incoming outside air, including pre-cooling the outside air when it is hot and pre-heating the outside air when it is cold, and may also recover energy used to dehumidify or humidify the outside air.

VRF systems include sophisticated controls integrated with the units that may not require a separate building automation system, when such a system is part of the project requirements. VRF systems include self-diagnostics and monitoring points, as well as the ability to communicate with a wide variety of other building systems with non-proprietary building automation communication protocols.

VRF systems combine many of the features of other HVAC systems, which offer energy efficiency with a limited number of components relative to systems with central plants. Such plants have limited space requirements particularly for the distribution system inside the building.

#### **WHY GSA IS INTERESTED IN VRF SYSTEMS**

GSA's Public Building Service (PBS) has jurisdiction, custody or control over more than 9,600 assets and is responsible for managing an inventory of diverse Federal buildings totaling more than 354 million square feet (ft<sup>2</sup>) of building stock. This includes approximately 400 buildings listed on or eligible for the National Register of Historic Places, and over 800 buildings that are more than 50 years old. GSA has an abiding interest in examining the technical performance and cost-effectiveness of different energy-efficient technologies in their existing building portfolio, as well as those currently proposed for construction. Given that the large majority of the GSA's buildings include office spaces, identifying appropriate energy-efficient solutions has been a high priority for the GSA, as well as for other United States federal agencies.

VRF is well suited to retrofit applications in older buildings because it can be added on or replace existing equipment in limited space, where there is currently limited or no ductwork. VRF may be the least expensive option in some of these cases, or offer a reasonable payback relative to other options. However, the many fan coils required introduce maintenance costs that may not have previously existed, such as for filter changes, and condensate system cleaning.

#### **STUDY DESIGN AND OBJECTIVES**

Surprisingly, despite the long history with VRF technology in Europe, Japan and elsewhere, the U.S. research community has not found useful research on VRF from these places. While some general literature is available about these systems (Goetzler 2007, Amaranth and Blatt 2008, Aynur 2010, EES Consulting 2011), there is a lack of critical evaluation of actual field energy performance. Research is currently underway evaluating the actual performance of VRF systems relative to rated full and part-load capacity and efficiency, as well as refining and validating energy modeling software that captures the complexity of VRF system operation in cooling, heating, and heat recovery.

This report is based on the available literature and discussions with industry. GSA does not have a complete VRF installation suitable for measurement and verification. The Moakley Federal Courthouse in Boston, Massachusetts has partially installed a VRF project, which is reviewed in this report.

Some information used in this report includes figures and tables provided by VRF manufacturers. This information is in no way intended to imply an endorsement or recommendation by PNNL, or the United States Government.

## PROJECT RESULTS AND FINDINGS

VRF HVAC systems are a mature technology. They are relatively new to the U.S. market and important questions about the actual energy savings remain unanswered. VRF systems can achieve 30% and higher HVAC energy cost savings relative to minimally code conventional compliant systems, or older inefficient systems and a range of building types (see Section V.A. for details and references). Limited energy simulation work described in the report shows that the percentage savings is similar across a broad range of climates. There are conventional HVAC systems optimized for energy efficiency, and newer systems such as radiant systems that can achieve similar levels of energy savings.

Costs and energy savings vary a great deal particularly for retrofit projects. It is not possible to define a single payback for the many applications of the systems, but there are opportunities to achieve reasonable paybacks on investments in VRF systems. Section V. A. shows that for packaged rooftop units, constant-air volume and variable-air volume (VAV) with hot water or electric reheat, simple paybacks of 15 years or less are possible. GSA should look for opportunities in buildings whose current or modeled energy usage is above average GSA building energy usage and energy cost and that have an incremental cost less than \$4.00/ft<sup>2</sup> relative to the alternatives. Chilled water VAV systems have similar potential simple paybacks, however the information available did not provide enough information from multiple sources to clearly distinguish the incremental cost and potential energy cost savings for air-cooled and water-cooled chillers, or air-cooled and water-cooled VRF systems.

The best opportunities for VRF systems include buildings with these target characteristics:

- inefficient HVAC systems and high energy costs
- lack of cooling or inadequate cooling capacity, although adding cooling capability or capacity may increase total energy usage despite possible reductions in fan and heating energy usage
- older and historical (in the National Register of Historic Places), with limited room to install or change systems
- new building projects that can take advantage of opportunities to reduce floor to floor height, or increase usable floor space by removing mechanical equipment from inside the main building areas.
- VAV systems with electric reheat or heat pumps with electric back-up heat. Up to a 70% reduction in HVAC energy is possible from a VRF system with exhaust air heat recovery when compared to a VAV system with electric reheat according to an energy modeling study (Hart and Campbell 2011).

- significant heating requirements – the Midwest and Northeast are good places to look for opportunities in this regard.
- inefficient fan systems
- leaky or poorly designed or installed ductwork
- already identified for HVAC upgrades, replacements, or energy improvements.

Buildings switching from gas heat to VRF systems offer large energy savings, but because of the price differential between electricity and gas, the utility bill savings will be greater when switching to VRF systems from VAV systems with electric resistance reheat or other electric resistance heating systems. This is especially true in buildings where switching to VRF systems would increase peak electricity demand.

Table 1 shows the results of an analysis described in Section V of this report that includes characterizing the energy savings potential of VRF systems, and the initial costs. This analysis indicates there is potential for GSA to implement 20 VRF projects over 5 years, with an average size of 50,000 ft<sup>2</sup> and average simple payback of 10 years.

**Table 1: Possible Application of VRF to Selected Parts of GSA’s Portfolio**

Building area affected, cumulative for five years of projects	1 million ft <sup>2</sup>
Total initial cost at \$24/ft <sup>2</sup>	\$24 million
Incremental initial cost \$3.00/ft <sup>2</sup>	\$3 million
Annual energy cost savings potential at \$0.29/ft <sup>2</sup>	\$290,000/year
Simple payback	10 years

Life-cycle costs including operating costs other than energy (such as maintenance and replacement costs of equipment) are also important in addition to initial cost. VRF systems are distributed systems and each fan coil unit requires maintenance, which includes filter changes, cleaning of condensate removal systems, replacement of fan motors and replacement of fan coils. Other distributed systems, such as conventional fan coils, water-source heat pumps (WSHP), and split systems have similar maintenance requirements. Because of the single compressor unit serving many zones, compressor unit maintenance and replacement is similar to other VAV and CAV systems. CAV systems often have more compressor units to serve a similar area than a VRF system. Air-cooled VRF systems do not have any central plant equipment to maintain or replace, and do not require a building operator, which may be required for larger buildings with a central plant.

A life-cycle cost analysis comparing a hypothetical HVAC retrofit in a 48,000 ft<sup>2</sup> building is presented in Section V in this report. VRF systems are compared with VAV direct expansion (DX) systems with electric reheat. A 30-year analysis using parameters and similar approach to the Federal Energy Management Program’s (FEMP’s) recommended method results in the net present value of the future costs and savings between the two systems (Fuller 1995). VRF is more expensive up front and in maintenance repair and replacement, but can still have a lower life-cycle cost because of energy cost savings. The comparison is sensitive to a range of inputs including (in particular) energy savings achievable by VRF and the energy rate.



This result is based on VRF saving 45% energy relative to the VAV with electric reheat alternative and an energy cost savings of \$0.29/ft<sup>2</sup> assuming the building has higher than average energy usage and higher than average energy cost per unit than the average GSA building.

**Table 2 Example Net Present Value Savings of VRF Compared to VAV with Electric Reheat**

	NPV	NPV, \$/ft <sup>2</sup>
Total Net Present Value Savings	\$81,560	\$1.70
Annualized Savings	Annual Savings	Annual Savings \$/ft <sup>2</sup>
Annualized equivalent savings, 30 year	\$4,161	\$0.087

The building portfolio energy savings potential for new buildings is less than for existing buildings just because the building floor area added each year is a small fraction of the existing building floor area. Some older buildings provide a better payback than is likely achievable with new buildings using VRF. This is because the energy savings potential is not as great as with some older, more energy-intensive buildings. The incremental initial cost of a new VRF system versus a conventional system can be greater than the incremental cost of retrofits selected where VRF's advantages (such as reduced space relative to ducted systems) are available. Relative to other energy-efficient HVAC systems including high-performance conventional systems and newer systems, such as radiant panels, VRF systems may offer comparable or even lower initial costs and similar or lower energy usage alternatives. This study was not able to compare VRF in detail with all of the higher performance new building options that compete with VRF, and focuses on the much greater combined energy savings potential of the existing buildings.

VRF systems may include about twice the refrigerant of comparable RTUs, depending on the size of the building area served according to one manufacturer<sup>1</sup> (Doppel et al. 2012). Concern has been raised about added cost associated with replacement of this refrigerant, and with refrigerant leaks. The same manufacturer responded that their integrated design and quality control requirements, the use of proprietary components rather than secondary market components, and their training programs reduce this risk of refrigerant leaks relative to other use of refrigerant lines such as grocery store refrigerated case work which is known to have substantial leak issues. This study did not identify any evidence that the systems leak significantly.

The dominance of these systems in non-U.S. markets suggests that operations and maintenance issues are not a major obstacle to adoption of the technology in the United States.

---

<sup>1</sup> phone conversation with P. Doppel, R. Willmarth, and A. Moore (Mitsubishi) with B. Thornton (Pacific Northwest National Laboratory). May 17 and May 30, 2012.

## RECOMMENDATIONS

GSA should consider targeted deployment of VRF to retrofit and new building projects based on the potential energy savings at a reasonable payback, or possibly even lower initial cost than other alternatives.

GSA should also include VRF systems as an alternative for building projects that have high energy-efficiency goals and possibly other sustainable building goals and corresponding budgets. VRF may be cost competitive or offer a reasonable simple payback and life-cycle cost compared to other high-performance HVAC system alternatives. The incremental cost relative to a low budget project with minimally code compliant buildings is less likely to result in a cost-effective implementation of VRF.

One obstacle to VRF projects is that manufacturers are often involved in the design of VRF systems. Structuring bid documents for open bidding for VRF systems can be difficult in this case.

### *Pilot Projects*

Starting with two or more pilot projects with VRF systems for existing and new buildings of different types with VRF systems is recommended. This will help develop a track record and control the risk because the technology is relatively new in the U.S.; most of the design and construction community are not experienced with it, and there is uncertainty about the energy savings. Building characteristics to target for pilot projects and all potential VRF projects are listed below.

Existing building projects, particularly pilot projects should include characterization of the existing building energy usage, ideally with some use of sub-metering to separate primary energy usage categories, especially cooling, heating, and fans. Effort should be made to establish a baseline of occupant satisfaction, particularly for comfort associated with HVAC.

New building pilot projects should include evaluation of an array of energy-efficient HVAC alternatives including VRF. Systems that should be considered include energy optimized conventional systems. Packaged DX systems and central chilled and hot water systems, VAV or fan coils, can be selected with efficient motors, fans, pumps (if included) variable-speed controls, energy recovery, demand-controlled ventilation, and for VAV, a coordinated strategy to minimize reheat. Water-source heat pumps and ground-source heat pumps can also be optimized for energy savings. Many high-performance features are now requirements under 2010 version of the national commercial building energy efficiency standard, ANSI/ASHRAE/IES<sup>2</sup> Standard 90.1-2010 (ANSI/ASHRAE/IES 2010). Other less conventional systems, such as radiant cooling and heating, and possibly chilled beams are also worth considering. The WSHP systems and the newer alternatives should include DOAS with energy recovery.

---

<sup>2</sup> ANSI – American National Standards Institute; ASHRAE – American Society of Heating, Refrigerating, and Air-Conditioning Engineers; IES – Illuminating Engineering Society; IESNA Illuminating Engineering Society of North America ( IESNA rather than IES was identified with Standard 90.1 prior to Standard 90.1-2010)

### *Building Characteristics to Target for VRF*

For existing buildings, GSA should focus on buildings determined to have an estimated incremental cost of under \$4.00 per ft<sup>2</sup> for VRF relative to the alternatives, and with energy usage and energy costs higher than the average GSA building. Existing buildings to target include one or more characteristics

- need for HVAC upgrades or cooling expansion with limited room for ductwork changes
- climates with significant heating loads
- buildings with electric reheat, supplemental heat, or primary heating
- 5,000 to 100,000 ft<sup>2</sup> (larger buildings can be evaluated on a case by case basis)
- buildings with enclosed spaces that would benefit from independent temperature control.

For new buildings, targeting high budget building projects with a “green” focus is recommended. Opportunity to reduce floor to floor height or increase occupied floor area using VRF rather than other HVAC alternatives should also be a focus. The size and climate characteristics identified for existing buildings also apply to new buildings.

### *Energy Analysis, Commissioning and Monitoring*

GSA should also consider conducting energy modeling during the design phase that is later reconciled with actual performance, particularly for new building projects because these provide no existing energy usage information to compare to. Evaluation of life-cycle costs should also be included. Commissioning, to ensure the project operates as designed, is important. Post-occupancy monitoring of energy usage separating energy usage categories should also be included and will require some planning and monitoring equipment to be included in building design and initial construction. Post-occupancy evaluation of occupant satisfaction and comfort is important, particularly for any pilot projects.

### *Participation in Development of Information about VRF Systems*

One of the current barriers for widespread implementation of VRF is the lack of independent information and verification of energy savings. A pilot project approach with careful tracking will help GSA to build its own certainty about the energy savings and other benefits and weaknesses of VRF.

Utility incentive programs have hesitated to support VRF because of this lack of information. If GSA is able to provide verification of energy savings for utility incentive programs, utilities will be able to claim the savings and provide incentives, helping with widespread implementation.

GSA may also benefit from and contribute to the dialogue and research under way by the Electric Power Research Institute (EPRI), Florida Solar Energy Center (FSEC), Southern California Edison (SCE), Bonneville Power Administration (BPA), United States Department of Energy (DOE), and manufacturers.

## II. Background

### A. ASSESSMENT

In 2010, under Executive Order 13514, federal government agencies issued sustainability performance plans with steps they will take to lower their greenhouse gas emissions. The U.S. General Services Administration plans aggressive measures to reduce its greenhouse gas emissions 30% by 2020. The agency also declared a long-term goal of reaching a zero environmental footprint. (GSA 2010)

GSA's Public Building Service (PBS) has jurisdiction, custody or control over more than 9,600 assets and is responsible for managing an inventory of diverse Federal buildings totaling more than 354 million ft<sup>2</sup> of building stock. GSA has an abiding interest in examining the technical performance and cost-effectiveness of different energy-efficient technologies in their existing building portfolio as well as those currently proposed for construction.

GSA developed the Green Proving Ground (GPG) initiative as part of achieving its energy-efficiency goals. The program is currently evaluating energy savings technologies, including multiple HVAC-related technologies, see <http://www.gsa.gov/portal/content/121935>.

One GPG target technology that is in common usage outside of the United States and beginning to enter the U.S. market is variable refrigerant flow (VRF) multi-split systems. These systems are also referred to as variable refrigerant volume (VRV) systems. VRFs are packaged outdoor compressor units connected through refrigerant lines to multiple refrigerant fan coil units in the building. Unlike most other targeted technologies in the GPG initiative, GSA does not yet have a targeted implementation of VRF in an existing facility suitable for a field case study. GSA has partially implemented a VRF system in the Moakley Federal Courthouse in Boston, Massachusetts, as described in this report. Instead, this report is a technology evaluation based on a literature search, and discussions with experienced industry members.

### B. OPPORTUNITY

VRF has about 24% of the global commercial air conditioning market, and over 35% market share in China, India, the European Union and Eastern Europe. The VRF share of the U.S. market is still only about 3% (LG 2012), but multiple manufacturers sell these systems in the U.S. and sales are growing. These manufacturers provide the products through an integrated supply system including installation and design training, and sometimes provide part or all of the design, as well as quality control. There is little secondary market for components.

The U.S. market has been slower to accept VRF technology for several reasons (Goetzler 2007, Amarnath and Blatt 2008, Aynur 2010). In Europe, many buildings did not have air conditioning, and adding ductwork was expensive or nearly impossible given space constraints. Europe has tended to provide cooling with chilled water fan coils rather than ducted systems. The United States has a long history with ducted HVAC

systems using both direct expansion (DX) systems and chilled water systems. VRF systems use more refrigerant than DX systems. Refrigerant lines distribute the refrigerant throughout the building, which raises concerns about leaks, and compliance with ASHRAE Standard 15 Safety Standard for Refrigeration Systems (ANSI/ASHRAE 2010) (which regulates refrigerant safety, and environmental and sustainability impacts).

VRF products have primarily been manufactured by Asian companies, which at one point had limited presence in the United States. Concern has been raised about committing to a particular manufacturer throughout the product life cycle because the products are not interchangeable, and there is no secondary market. Prior to the introduction of AHRI Standard 1230-2010 by the Air Conditioning Heating and Refrigeration Institute (AHRI), there was no standard for VRF product performance certification (ANSI/AHRI 2011). Now there is a product directory of certified equipment (AHRI 2012). Minimum efficiency requirements were introduced in ASHRAE Standard 90.1-2010. Design and other information from non-manufacturers has been scarce, but this has been partially remedied by the introduction of a VRF section in the *2012 ASHRAE Handbook, HVAC Systems and Equipment* (ASHRAE 2012a).

One significant barrier to the technology is the uncertainty in estimating savings. There is not a complete, independently developed energy simulation protocol, nor is there commonly available real energy savings results isolated to VRF savings. One barrier this creates is that some energy-efficiency incentive programs are holding back from offering incentives for VRF. Lab work, field studies, and software development are being performed by the Electric Power Research Institute (EPRI) and the Florida Solar Energy Resource Center (FSEC), with support from the U.S. DOE, Southern California Edison (SCE) and Bonneville Power Administration (BPA). SCE has had an upstream VRF incentive program for VRF suppliers since 2010. BPA has begun a small field test of 10 projects to determine whether whole building energy analysis can be used to verify savings. Several other utilities, including Efficiency Vermont and the Energy Trust of Oregon provide VRF system incentives equal to air-source heat pumps.

Six major VRF system manufacturers are currently active in the U.S. market and have products certified by AHRI (AHRI 2012). Finding multiple design and contractor options experienced with VRF systems may be more problematic in some areas. For GSA, following its standard design-bid-build process is difficult for VRF systems because of the common manufacturer involvement in the design phase.

Initial costs for VRF systems in new building are generally significantly higher for VRF than for conventional systems (although this is disputed by some manufacturers). Costs may be more comparable to other high performance HVAC systems. Greater variation in costs caused by different building characteristics is found in the retrofit market and ranges from VRF systems being less expensive to prohibitively more expensive than other choices.

VRF systems are innovative, although not unique in a number of features. The major energy savings potential comes from the following:

- variable-speed air-cooled compressors (or at least some compressor elements) providing high part-load cooling and heating efficiency,
- reduced fan energy caused by low static pressure and elimination of ductwork for space cooling and heating reduces fan energy; smaller ductwork for delivery of outside air will still be required in most cases,
- refrigerant, rather than water or air, requires less energy to move the heat transfer fluid,
- some units are capable of heating and cooling at the same time to different zones without reheat, and providing heat recovery between zones in heating and cooling at the same time
- common use of dedicated outside air systems with energy recovery.

VRF system technology is described further in Section III of this report.

Actual and simulated energy savings depend on many factors discussed in Section V of this report. One study suggests an average 5% to 20% HVAC energy savings for VRF systems compared to a variety of HVAC systems is a reasonable range (Amarnath and Blatt 2008). Another study provides examples primarily from simulation studies that achieve 5% to 57.9% HVAC energy savings for VRF systems compared to a variety of HVAC systems, concluding that an average value of 20% HVAC savings is reasonable in characterizing the potential savings with widespread implementation of VRF systems in the Northwest (EES Consulting 2011). Other simulation studies and anecdotal information suggests HVAC energy savings in the 30% to 60% plus range is possible. This study concludes that HVAC energy cost savings of 34% is achievable for VRF relative to VAV with hot water reheat, and CAV with gas heat, and 45% HVAC energy cost savings relative to VAV with electric reheat compared to a variety of conventional existing, or code minimum efficiency, new HVAC systems across a range of building types and climate settings. The average HVAC energy cost savings of VRF is estimated as 34% compared to VAV with chilled water and electric reheat, and 26% compared to VAV with chilled water and hot water reheat, but this a broad estimate and the data doesn't distinguish between air-cooled and water-cooled chillers, or VRF systems. These savings percentages are based on the information found for this report and should be reviewed at the time VRF systems are being considered as there is a lack of field verified energy savings information.

Other HVAC systems, if designed with energy efficiency as a primary goal, can provide similar energy performance and are worth considering when considering VRF. These systems include water-source and ground-source heat pump systems, split systems, fan coils, radiant systems and VAV systems with advanced controls, all with exhaust air energy recovery in most climate locations. These system alternatives are part of the recommendations to reduce energy 50% relative to ANSI/ASHRAE/IESNA Standard 90.1-2004 (ANSI/ASHRAE/IESNA 2004) in the *Advanced Energy Design Guide for Small and Medium Offices (AEDG-SMO)* (ASHRAE/AIA/IESNA 2011)

VRF provides a significant opportunity for GSA. GSA's Public Building Service (PBS) has jurisdiction, custody or control over more than 9,600 assets and is responsible for managing an inventory of diverse Federal buildings totaling more than 354 million ft<sup>2</sup> of building stock.

Because VRF systems are less intrusive than many other HVAC system options, they can be of particular benefit to historic and other older buildings. These buildings may have no cooling, or inadequate cooling and heating capacity, inefficient and poorly operating HVAC systems, space constraints preventing addition of or modification to ductwork, and in the case of historic buildings, restrictions on building changes that disrupt the appearance of the building. Adding cooling will probably increase cooling energy usage and peak demand (kW), although this may be offset entirely by fan and heating energy savings.

Energy savings for the entire GSA portfolio is difficult to estimate with any degree of accuracy because cost, energy savings, and economic value, will vary greatly between buildings. As estimated in Section V. A of this report, payback can vary from 1 year to more than 30 years because of differences in the type of building, the type of existing HVAC system, the incremental cost relative to other alternatives, and the cost of energy for the building, which can vary based on building envelope, lighting, plug loads, occupancy density, operating schedule, climate, and type of building.

However, by applying VRF systems to 1 million ft<sup>2</sup> 20 GSA buildings over the next five years, GSA could save \$290,000 in energy costs per year once all of the projects were in place as calculated in Section V. C. The best candidates for VRF technology will be older, inefficient buildings, due for retrofit. The buildings most likely to benefit from VRF systems have multiple rooms with independent occupancy, varying comfort requirements and areas with enclosed offices and other enclosed rooms. In colder climates, buildings that switch to VRF systems from VAV systems with electric reheat, or other types of electric resistance heating offer large energy cost savings. Switching from natural gas heating offers less energy cost savings because natural gas is significantly less expensive than electricity per unit of heating.

### III. VRF Systems Technology

VRF HVAC systems are a mature technology prevalent in the market outside the United States. However, there is a lack of independent verification of energy savings potential or high certainty about the energy impact.

One way of categorizing the maturity of a technology is a 9-point scale called Technology Readiness Levels (TRL) (Mankins 1995). The U.S. Department of Defense (DOD), Federal Energy Management Program (FEMP), National Aeronautics and Space Administration (NASA), European Space Agency (ESA), private companies and other organizations use similar rating systems. TRL is used to categorize the status of a technology's readiness for deployment in the market. A 1 rating means basic principles have been observed and reported, and a 9 rating means the actual system has proven itself through successful real world operation. VRF has proven itself in real operation and is a 9 on the TRL scale.

The DOE and FEMP are developing a new scale called Deployment Readiness Level (DRL) as part of their Technology Deployment Matrix (FEMP 2012). This is a three-part rating system summarized as 1) basic commercial availability, 2) adequate supply chain with demonstrated success in the market, and 3) part of a robust competitive market. In the U.S., VRF is not yet part of a robust competitive market and meets the DRL rating of 2; in some areas of the world, it meets a DRL rating of 3.

#### A. VRF EQUIPMENT

VRF systems generally include one or more air-source outdoor compressor units serving multiple indoor fan coil refrigerant evaporator units. Water-source compressor units are also available and can be installed indoors.

**Figure 1: VRF Compressor Unit and Fan Coil Units (enlarged relative to compressor unit)**

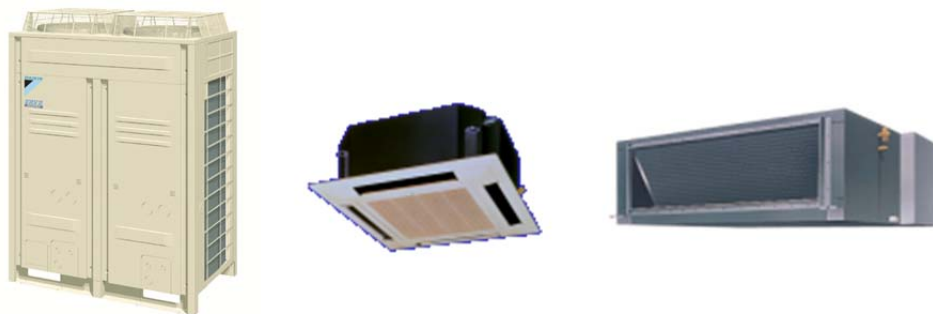

(Reprint with permission of Daikin)



This type of system is distinguished from small split systems that may serve a maximum of three indoor units without variable refrigerant flow. These systems are often referred to as ductless mini-splits, or multi-splits, which are typically applied in residential or small commercial buildings and are not covered in this report.

The individual compressor units vary in size from 6 to 30 tons for units without heat recovery, and 6 to 24 tons for units with heat recovery. In some cases, one or more compressor units may be integrated into effectively one system serving a larger combined load. Fan coil unit capacity typically ranges from 0.5 to 8.0 tons of cooling. A total of 60 or more indoor units can be served by a single compressor unit, and the total peak capacity of the fan coil units can exceed the peak capacity of the compressor unit, allowing for diversity in the loads.

VRF provides an innovative package of energy savings features.

- The compressor unit includes two or more scroll or rotary compressors, at least one of which is an inverter-controlled variable-speed variable refrigerant flow compressor. The variable-speed compressor units are rated at significantly higher part-load efficiency than constant-speed systems.
- The indoor fan coil units are connected to the compressor units with refrigerant piping, similar to a conventional split systems. Using refrigerant to deliver heating and cooling requires less energy because of the larger heat capacity of the refrigerant relative to air and even water. Less mass flow is needed to deliver the same amount of heating or cooling. The refrigerant still needs to be pushed through the piping, and as piping runs lengthen to serve large and taller building, increasing energy will be used at the compressor to maintain the flow of refrigerant.
- The fan static pressure for the fan coil units in or close to the conditioned space with little or no ductwork is much less than that of a central air system. Providing outside air generally requires a separate fan system with ductwork and higher static pressure than the fan coils, but with a fraction of the air flow and fan power than from conventional all-air HVAC systems. Buildings that can depend on natural ventilation can avoid this additional fan power. The elimination of most of the ductwork avoids duct air leakage and has the benefit of reducing the volume of space needed for ductwork, and the amount of ductwork and possibly hydronic piping needed to deliver conditioning to the space.
- The fan coil units may operate with variable-speed control using electronically commutated motors (ECM). The ECMs may also just be used to set the speed and air flow at installation. ECMs are more efficient than standard split capacitor fractional horsepower motors, which might otherwise be used with small fans.
- The systems can be configured to deliver cooling only, or heating and cooling. Some systems provide cooling to some zones and heating to other zones at the same time. When the system has the capability for cooling and heating different zones at the same time, occupant comfort is improved without the use of reheat unlike a conventional VAV system.
- Units capable of cooling and heating different zones at the same time also provide refrigerant heat recovery. **Figure 2** shows a basic layout of such a system showing the compressor unit; the refrigerant collector, which plays a role in the heat recovery; and the indoor fan coil units, some in

heating and some in cooling. This is not unlike a water-source heat pump system, but the heat recovery occurs within the refrigerant loop of a compressor unit and the attached fan coil units, not between multiple compressor units as with a WSHP system. The VRF system uses smaller- diameter refrigerant piping and does not require a cooling tower and boiler. Some degradation of system capacity and increase in power results when operating in refrigerant heat recovery mode (FSEC 2012).

- Multiple compressor units can also be connected to a water-source loop like a conventional WSHP system. This allows heat recovery between compressor units.
- Heat recovery can also be used for service water heating, potentially a major benefit in buildings with significant service water heating loads and cooling throughout the year.
- In some cases, two outdoor units may be integrated into effectively one system. This can increase the potential for heat recovery because there may be more diversity in loads with an increase in the number of different spaces served. Some multiple compressor unit systems can reduce the impact on space conditioning that can occur in single compressor units when these units switch to defrosting their coils; one compressor unit can continue to provide conditioning when the other unit is in defrost.
- The compressor units can operate at low outdoor air temperatures. Some manufacturers report that their units can provide up to 70% of their rated heating capacity at  $-7^{\circ}\text{F}$ . This can eliminate the need for a supplemental heat source in some climate zones. In some conditions, a full backup heat source may be needed if the outdoor temperatures fall below the operating range of the compressors. Compressors that can perform at even lower outdoor air temperatures using dual-stage compressors or flash injection heating are available (ASHRAE 2012a).

**Figure 2: VRF System with Zones in Heating and Cooling with Heat Recovery**

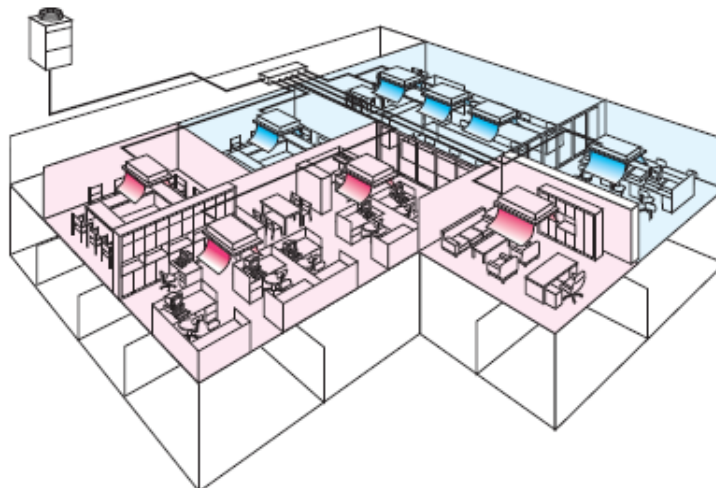

(Reprinted with permission from Mitsubishi)

VRF systems from different manufacturers are configured in different ways to provide heating and cooling of different zones at the same time and heat recovery. A two-pipe system delivers heating or cooling to each space through one pipe to the fan coil with the second pipe returning refrigerant to the compressor. A three-pipe system includes separate cooling and heating lines to each indoor unit and a return line.

In both two-pipe and three-pipe systems with refrigerant heat recovery, one or more heat recovery units are included between the compressor unit and the fan coil units. This unit controls the flow of liquid and vapor refrigerants between the fan coil units in heating or cooling mode, and minimizes the load on the compressor. Methods vary by manufacturers who provide their own valves, heat exchangers, controls and other components. **Figure 3** includes simplified diagrams of two configurations with heat recovery. More detail on the heat recovery operation and more complex configurations are used in practice, as shown in the *2012 ASHRAE Handbook, HVAC Systems and Equipment* chapter 14 (ASHRAE 2012a).

**Figure 3: VRF Heat Recovery System Configuration Options**

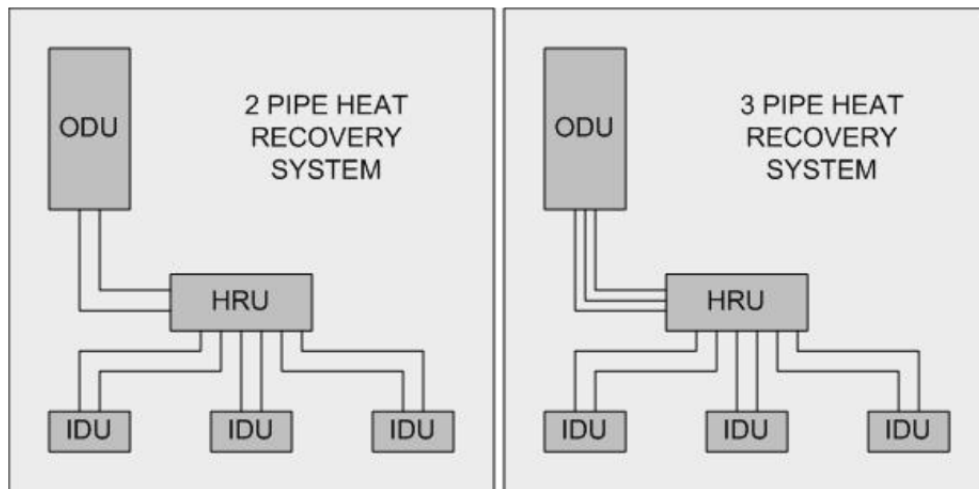

(Reprinted with permission, Demetrovic and Upadhye 2012)

ODU Outdoor Unit -compressor unit, HRU Heat Recovery Unit, IDU Indoor Unit – fan coil units

The fan coil units are available in ductless and ducted form. Ductless fan coil units discharge and return air directly to and from the conditioned space through the unit. These fan coil units are mounted on the wall, at the floor, or on the ceiling (sometimes called a cassette unit). Units can also be ducted from a fan coil in a location not visible from the space with supply and return grilles in the space referred to as a concealed unit. This can be problematic because fan coils may not be available to provide large enough air flow to serve multiple zones, or sufficient fan power to overcome the pressure drop in the duct system.

The fan coil units are equipped with condenser water drains and can be used to provide at least some dehumidification. Small condensate pumps are required, which need piping and wiring, typically over occupied spaces. The noise from the condensate pumps has been reported as a distraction.

These systems include integrated controls to coordinate the flow of refrigerant. The systems include multiple monitoring and control points and automated diagnostic capability. Most, if not all, VRF systems can communicate with other equipment, such as an energy management system, through open protocols including BACnet and LONworks.<sup>3</sup> The systems can also serve as their own energy management system for small buildings.

VRF systems may include optional refrigerant-to-water heat exchange for pre-heating service hot water, or for providing chilled or heated water for radiant cooling and heating applications (ASHRAE 2012a). Water temperatures up to 160°F may be possible with a supplemental booster refrigeration cycle. The service water heating option is a good application when space cooling is needed year-round, and there are significant service water heating loads.

Less frequently, water-source compressor units are linked by a common water loop served by a cooling tower and heating source similar to WSHP systems. The water-loop cooling source is typically a cooling tower; the heating source is typically a boiler; ground-source well fields, ground or surface water, or waste heat can also be used. If a boiler is used, this becomes the primary heat source and does not reduce heating energy usage. A cooling tower uses evaporative cooling to pre-cool the water in the loop more efficiently than a compressor unit. The VRF compressor unit then rejects heat to this pre-cooled water, operating more efficiently than when rejecting heat to outside air at higher temperature. Using a ground-source well field instead of a boiler and cooling tower provides large additional energy savings although ground-source well fields are typically more expensive than central plant equipment.

When multiple compressor units are connected through the water loop, heat recovery between the compressor units can occur when some compressor units are operating primarily in cooling and other units are operating primarily in heating. At the same time, heat recovery can occur in the refrigerant loop connected to each compressor unit, as described above.

---

<sup>3</sup> BACnet is a communications protocol for building automation and control networks. It is an ASHRAE, ANSI, and ISO standard protocol. LONworks is a local operation network, it is a networking platform created to address the needs of control applications. The platform is built on a protocol created by Echelon Corporation for networking devices over media such as twisted pair, power lines, fiber optics, and radio frequency. The protocol is also one of several data link/physical layers of the BACnet ASHRAE/ANSI standard for building automation.

## B. VRF SYSTEM EFFICIENCY

Prior to the release of ASHRAE Standard 90.1-2010, there were no efficiency requirements for VRF systems. The certification standard referenced in ASHRAE Standard 90.1-2010 is AHRI Standard 1230-2010 (ANSI/AHRI 2011). A product directory of certified equipment is available in a PDF format; unfortunately a sorting and lookup capability is not available on the website (AHRI 2012).

One of the challenges with testing VRF systems is knowing what to test. Developing a consistent and representative testing method has been difficult because the system performance varies with the number and size of fan coil units, ducting if any, length of refrigerant piping, and loading conditions at each fan coil unit. The AHRI certification test method requires four fan coil units to be connected to the compressor unit. The test is done at 25%, 50%, 75% and 100% loading by loading one, two, three or four of the fan coil units. This allows determination of full and part-load efficiency of the compressor. Because the efficiency of the units varies significantly with the many variations in system configuration relative to the test, some controversy remains whether the AHRI Standard 1230-2010 test method is truly representative of actual performance. Efficiency ratings in cooling and heating mode are currently provided with ducted, non-ducted and mixed ducting values provided. Requirements and certification for heat recovery operation are being developed.

“Table 6.8.1 | Electrically Operated Variable Refrigerant Flow Air Conditioners – Minimum Efficiency Requirements” in ASHRAE Standard 90.1-2010 lists a full range of minimum efficiency requirements for air-cooled, water-source and ground-water source VRF heat pumps in cooling and heating mode. These include full-load energy-efficiency ratio (EER) values, and part load, integrated energy-efficiency ratio (IEER) values expressed in Btu/W·hr and are a measure of the cooling produced (Btus) for the amount of energy required to produce it (W·hr). These include values for equipment manufactured prior to July 1, 2012, and higher efficiency values effective July 1, 2012.

IEER is calculated with the sum of weighting factors applied to tested efficiencies at four part-load conditions:

$$\text{IEER} = (\text{EER @ 25\%} \times 0.125) + (\text{EER @ 50\%} \times 0.238) + (\text{EER @ 75\%} \times 0.617) + (\text{EER @ 100\%} \times 0.02).$$

In many size ranges, the minimum requirements for VRF efficiency are higher than for conventional unitary equipment, particularly for part-load performance. For example, for air-cooled unitary air conditioners between 135,000 Btu/h and 240,000 Btu/h, the requirements are 10.8 EER and 11.0 IEER. For the same size range, VRF requirements are 11.0 EER and 12.9 IEER (12.3 IEER prior to July 1, 2012). Required heating efficiency of unitary heat pump equipment including VRF systems is expressed with a minimum coefficient of performance (COP) (similar to EER, but in Btus/Btus), the unit of heating in Btus divided by unit of energy input also in Btus, so the resulting expression is a unitless number. For VRF units, the 90.1 2010 heating COP minimum requirements are the same as for unitary heat pumps or a little higher in some cases. These values

are minimum efficiency requirements. Certified efficiencies of products show significantly higher efficiency values.

The VRF variable-speed compressors result in high part-load efficiency values. **Figure 4** displays an average VRF (VRV used instead of VRF in original source of figure) part-load performance curve provided by a manufacturer showing how loading conditions are distributed and how efficiency reaches a peak at intermediate part-load conditions representative of typical VRF operating efficiency.

Review of the AHRI-certified products directory reveals that most air-source VRF systems have IEER ratings in the 16 to 20 range with some higher values. There are at least two product lines closer to the allowed minimum in the 13 to 14 IEER range (AHRI 2012).

A review of the conventional unitary equipment certifications in the AHRI database for high-efficiency units shows that multiple manufacturers have significant numbers of 15-ton units and some larger size units with IEER values 14 and greater, and one manufacturer has units with IEER values above 17. The available performance of certified unitary AC units overlaps the range of efficiency for VRF systems, providing options for efficient system selection.

AHRI product certifications include air-source VRF units with heating COP values that are typically 3.2 to 3.5, with some higher values. Conventional heat pumps are required to have a minimum 3.2 to 3.3 COP. Limited heating energy savings seems possible relative to a conventional air-source heat pump.

Figure 4: VRF Part Load Performance

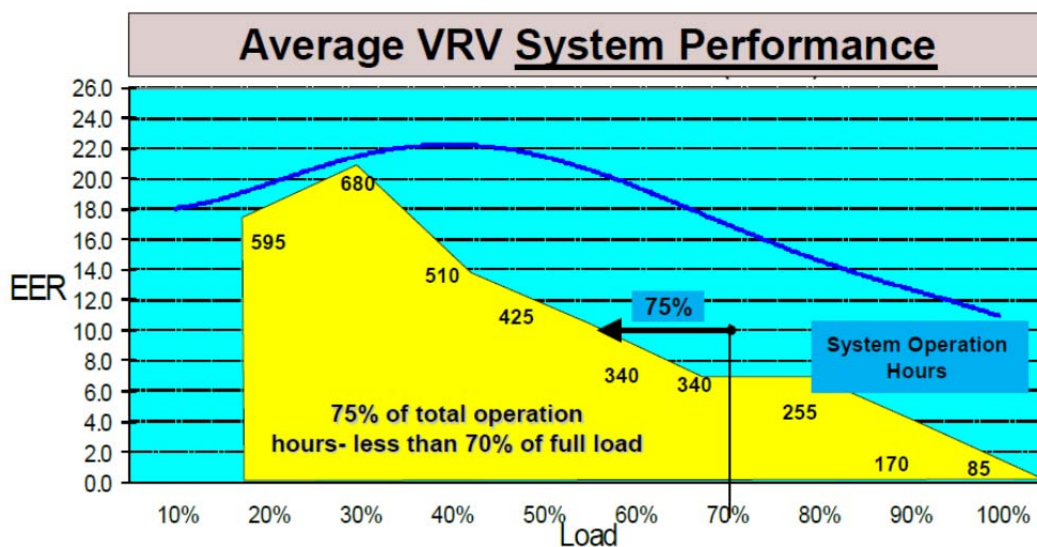

(Included by permission from Daikin)

VRF equipment is now included in the Consortium for Energy Efficiency (CEE) *High Efficiency Commercial Air Conditioning and Heat Pump Initiative* (CEE 2012), which helps organize and guide the movement of unitary equipment to higher efficiency levels. Efficiency targets for VRF systems are now included in two tiers above those in ASHRAE Standard 90.1-2010.

### C. OUTDOOR AIR

Typically, VRF systems provide only space cooling and heating by recirculating air within the space; outdoor air has to be provided separately. Fresh air can be ducted to the indoor fan coils directly or even be introduced by natural ventilation. Typically, a separate dedicated outside air system (DOAS) will be used. DOAS are not unique to VRF systems and are used with many different types of systems, especially systems that do not deliver heating and cooling using air from a central source but use water or refrigerant. This includes chilled and hot water fan coils, WSHPs, radiant cooling and heating, and conventional split systems.

DOAS systems are often equipped with energy recovery or heat recovery. Energy recovery, primarily with heat wheel recovery units, allows sensible (energy contained in the dry air) and latent (energy contained in the moisture content of the air) heat to be exchanged between the entering outside air and the exhaust air. In humid climates, much of the energy associated with cooling is to remove the moisture from the air through condensation. Recovering part of this energy is done through latent energy recovery by transferring incoming moisture to the exiting air, which was previously dehumidified. When heating, energy recovery pre-heats (and possibly humidifies) cold entering air with exhaust air from the space, recovering some of the energy used to heat the space. Heat recovery only systems just allow recovery of sensible heat, which is appropriate in climates where humidity or lack of humidity is a significant concern.

Dedicated outside air systems provide energy savings, particularly with exhaust energy recovery, and substantial air quality benefits (ASHRAE 2012b). DOAS units with energy recovery are incorporated in most of the HVAC systems recommended in the *Advanced Energy Design Guide for Small and Medium Office Building*, a guide to 50% energy savings relative to ASHRAE Standard 90.1-2004 compliant designs (ASHRAE/AIA/IESNA 2011).

Control of a DOAS and coordination with the control of the VRF fan coil units can be problematic. A DOAS should be operated on a temperature reset schedule so that it can provide a cooling benefit when outside air temperatures allow, and cooling is needed in the space. VRF controls may not be set up for the level of zone information needed for an effective reset based on space conditions; a reset based on outside air temperature could be used in this case.

In some retrofit installations, existing HVAC systems have been left in place to provide outside air and have left thermostat control in place, which results in adjustment of the outside air temperature delivered to the space or to the fan coil unit. This will result in a lack of control coordination and possibly cycling between the existing HVAC system and the VRF system and excessive fan energy use, particularly if the RTU is constant volume and continues to operate at full air volume continuously to provide outside air. VRF manufacturers

provide a control interface unit that can help mitigate this problem, but it is quite expensive. Replacing the unit with a DOAS sized to meet just the outside air requirement can still allow using the existing ductwork with some modifications to ensure proper velocities in the space to maintain air distribution.

Dedicated outdoor air systems, particularly with energy recovery, are not a necessary part of VRF systems and is not a focus of this paper except where indicated.

#### **D. MERITS AND LIMITATIONS**

VRF systems offer advantages other than energy savings, including ease of installation, integrated controls, and comfort. There are also limitations including the lack of economizers, concerns about refrigerant and the proprietary nature of the VRF systems. There is also uncertainty about energy savings, which is discussed in Section V. A of this report.

##### **MERITS**

###### *Installation*

VRF system components are modular, small and lightweight compared to conventional HVAC system components. They are typically installed without the use of a crane, saving substantially on installation cost. The unit modularity supports building a system over time to serve floors as a building is occupied. The low weight can reduce the need for structural reinforcement to support more massive equipment. The compressor units are typically installed outdoors and do not need a machine room or mechanical penthouse (Goetzler 2007).

###### *Controls*

VRF systems incorporate sophisticated controls and automation; control of the complex refrigerant system requires this. Manufacturers highlight the many control points allowing careful monitoring and easy troubleshooting, including automatic diagnostics and communication of issues to maintenance. A control system is set up to communicate among all components and can operate as an energy management system within the network of systems. The control system can network with the rest of the building with open protocols such as BACnet and LONworks. Providing a comparable level of control with conventional equipment would add additional cost to those systems. The controls also allow rapid startup and configuration, and limited commissioning is required for warranty; additional commissioning is required to verify smooth control when switching between heating and cooling. As an option (that adds significant expense), the refrigerant flow to each fan coil unit can be automatically measured, allowing the energy usage of the system to be allocated to each tenant.

###### *Comfort*

Fan coil units can be sized to serve small spaces with independent temperature control, such as individual private offices. This adds cost relative to sizing units to serve larger combined zones but can improve comfort. With capability to provide heating or cooling and modulation of the compressor, a narrow temperature range can be maintained. Anecdotal information, and results of one informal field study (Price



2009) indicate that attention needs to be paid to ensure that controls are working to maintain stable temperature control without alternating heating and cooling. Commissioning of zone temperature control is recommended.

### *Space Requirements for Delivery of Heating and Cooling*

Transferring heat through refrigerant piping requires a lot less space than ductwork. This makes VRF systems well suited to retrofits, particularly historical buildings that may not have any ductwork or cooling. However, if outside air requirements are not met by natural ventilation already, then ductwork of sufficient size to provide code-required ventilation will need to be added. In new buildings, the low space requirement can result in reduced floor-to-floor height, providing initial cost savings.

### *Maintenance*

Regular maintenance of VRF systems consists of changing filters and cleaning coils for the fan coil units. This level of maintenance is not substantially different than for other zonal systems, such as conventional water-source fan coils and split systems. Less maintenance is required for conventional rooftop equipment. Maintenance of the compressor unit is minimal, and there will be significant maintenance savings for this part of the system compared to chilled water and hot water plant equipment.

## LIMITATIONS

### *Lack of Economizer*

Because there is no ductwork to deliver heating and cooling, there is no air-side economizer and because the system is refrigerant-based and not water-based, there is not an option for a water-side economizer. With a DOAS sized just for the required amount of outside air, a limited air economizer is available. A full or partial air-side economizer is an option available with a DOAS unit when sized accordingly. Some manufacturers offer a full air-side economizer option with a DOAS requiring full-sized ductwork. However, some manufacturers argue against adding an economizer because they think it will reduce the amount of heat recovery.

**Figure 5** shows the impact of economizers on cooling energy and total HVAC energy usage for a packaged rooftop VAV system for a cross section of climate zones. In some climate settings, economizer energy savings not captured with the VRF system will partially or even completely eliminate the net energy savings for cooling that might otherwise be possible with the VRF system (Hart and Campbell 2011). In the mild climate of Salem, Oregon, the cooling energy savings for an economizer is 29%, which accounts for over 11% of total HVAC energy usage. Together, VRF cooling, fan and heating energy savings can offset the lack of an economizer, and still result in significant net savings, as described in Section V. A of this report.

A prototypical medium-sized office building energy model in EnergyPlus was used to develop these values. The model used for this analysis was part of a set developed to help analyze the energy impacts of changes in ASHRAE Standard 90.1 (Thornton et al. 2011).

Figure 5: Economizer Savings

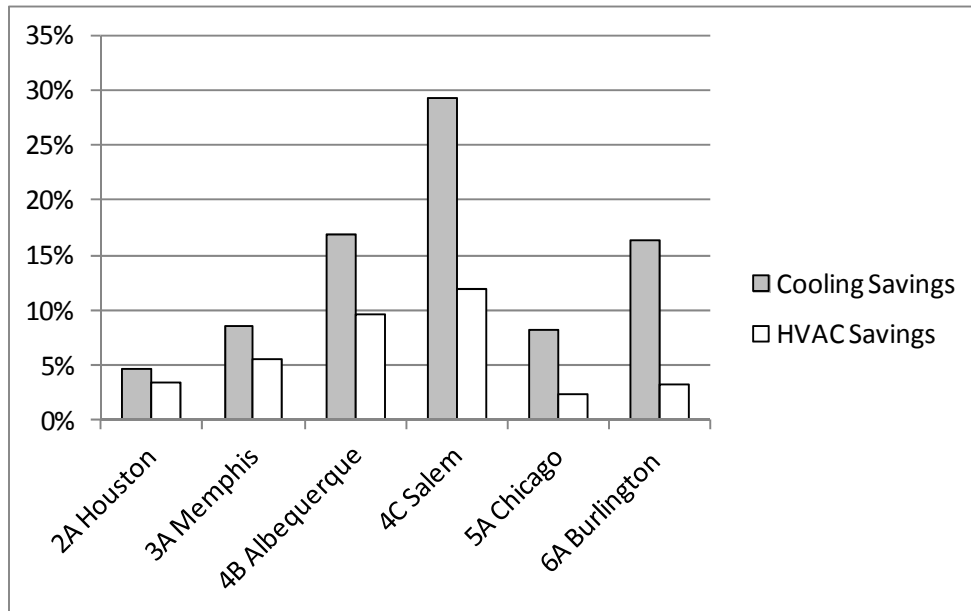

Economizers are required by energy codes and standards, but VRF systems may be exempt in some codes and standards. Standards and codes typically have size thresholds, below which a unit does not need to meet the economizer requirements, and many VRF fan coils fall below those limits. Some jurisdictions treat the compressor unit capacity as the system capacity. In these cases, the system may qualify for an exception based on the compressor unit cooling efficiency exceeding the standard minimum efficiency requirement by a percentage or other measure. Washington state code allows a VRF exception for economizers when the VRF system has refrigerant heat recovery and includes a DOAS system with exhaust heat recovery. To meet local code in Seattle, Washington, energy modeling is required to prove the VRF system provides a net energy savings without an economizer.

### Refrigerant

Concerns have been raised about health, expense, and environmental impacts from refrigerant leaks. The grocery store industry has experienced major problems with leakage in refrigeration systems leading to a movement away from the delivery of cooling with refrigerant. Concern exists about possible leaks from flare fittings provided by the manufacturer, and some installers use braised connections. Finding leaks is difficult.

In response to these concerns, manufacturers maintain that leakage can be minimized with proper training, which the manufacturers require and provide, coupled with installer experience. The refrigerants are non-toxic, and no health problems have been reported from these installations. Use of continuous tubing for the refrigerant lines can also limit joints. Properly installed, flare fittings do not leak, and allow the system to remain easier to reconfigure. Some manufacturers require heightened piping pressure tests for an extended period. The grocery store leakage issue may be related to the use of aftermarket components that may not

be compatible with existing installations, a variety of installers without coordinated training, and lack of quality control involving the suppliers and manufacturers, which is not the case with VRF systems.

Further research may be needed to resolve the degree to which leaks occur, determine if that level of leakage is a problem and identify how to prevent further leakage.

With long refrigerant lines passing through small spaces, the refrigerant-to-space volume could exceed the ASHRAE Standard 15 limit, triggering requirements for refrigerant mechanical rooms under ASHRAE Standard 15 (ANSI/ASHRAE 2010). A designer reported running into this problem with a small electrical room<sup>4</sup>. The solution developed for that project was to connect the space to other spaces with transfer grilles and fire smoke dampers, which added cost (McConahey 2012). The designer shared that a better solution being applied is to use solenoid valves to limit the quantity of refrigerant that could be released into the space. Another approach is to increase the number of VRF systems to reduce the amount of refrigerant in each system.

### *Proprietary systems*

Components are not compatible across manufacturers, and there is no secondary market for components. Building owners are a captive customer once the system is installed, exposing them to a lack of price competition for replacement parts and future building retrofit projects. A benefit of this can be maintaining an integrated system with coordinated control and quality assurance.

Manufacturers are often involved in the design of VRF systems. Structuring bid documents for open bidding of VRF systems is difficult because of manufacturer involvement in the final design.

## **E. ONGOING RESEARCH**

One research project will provide performance information under different conditions for both VRF heat pump and heat-recovery systems for incorporation into building simulation models. This non-manufacturer-funded lab testing is being performed by Florida Solar Energy Center and EPRI and is funded by Bonneville Power Administration, Southern California Edison and U.S. DOE. This research is raising questions about possible differences between actual VRF performance and the AHRI-certified performance. The EPRI lab testing has a different approach and a different purpose than the AHRI testing. In the AHRI testing, some variable settings are fixed by the manufacturer, while the EPRI lab testing allows the system settings to vary, similar to how they will perform in buildings. In the lab, loading of the fan coil units is done partially by setting the space thermostat outside of its typical setpoints. There is a dialogue underway between researchers and the industry exploring these observations.

---

<sup>4</sup> Telephone conversation with E. McConahey, Principal (Arup), and B. Thornton (PNNL), April 26, 2012, Portland, Oregon.

One earlier informal field study was done by the Eugene Water and Electric Board, which supports the need for continuing research like that being carried out by FSEC and EPRI (Price 2009). This study identified issues with field performance of a 6-ton VRF system with six fan coil units. Energy performance was below expectations, and there were temperature control problems.

Bonneville Power Administration has started a project to use field tests to develop a method to verify electricity savings for VRF systems (BPA 2012a).

The Northwest Power and Conservation Council's (NWPPCC) Regional Technical Forum (a body that provides guidance to the NWPPCC and other organizations on energy-efficiency issues) hosts a variable capacity heat pump sub-committee. The variable capacity heat pump sub-committee web page contains many VRF-related presentations, which can be found at <http://www.nwcouncil.org/energy/rtf/subcommittees/vchp/Default.htm>.

## IV. Project Examples

The GSA Green Proving Ground technology evaluation projects have generally been based on detailed evaluations, including field measurement and verification (M&V) supporting technology implementation. For the VRF evaluation, a project was identified, but a field evaluation study was not performed because the design and installation was not suitable for measurement and verification. Pacific Northwest National Laboratory (PNNL) conducted a site visit and evaluation of the project plans and description. A description of this project, along with brief summaries of four VRF projects in the Northwest, is provided below.

### A. MOAKLEY U.S. COURTHOUSE

#### DESCRIPTION

The John Joseph Moakley U.S. Courthouse in Boston Massachusetts is a 10-story building with a basement mechanical room. The building is served by water-cooled chillers and an ice storage system. Boilers provide hot water for heating. The chilled water and hot water pumps are equipped with variable-frequency drives (VFDs), and the condenser water system is constant flow. Space conditioning is provided by VAV air handlers with hot water reheat. The chilled water system includes an ice storage system, which is the primary cooling source during occupied hours. The chiller normally only runs at night to recharge the ice storage because conditions for operating the cooling tower efficiently are better. There are 35 AHUs. Nine of these are located on the 10<sup>th</sup> floor; the rest in the basement.

The energy usage of the different elements of the system is not tracked. Energy usage is not sub-metered at the separate plant and air-handler equipment level, so determining the before and after energy impact of changes is difficult at best.

A plan was developed to replace the space cooling and heating (but not the existing AHUs) in the east and west wings on the 9<sup>th</sup> and 10<sup>th</sup> floors. VAV air-handler unit AC 26 serves the west wing of both floors and AC 27 serves the east wing of both floors. AC26 provides 26,300-cfm supply air flow, and AC27 provides 27,100-cfm supply air flow, both with design total static pressure of 5.9-in. w.g. and 50-hp fan motors.

The original plan included installing 12 water-cooled compressor units, 5 for the 10<sup>th</sup> floor with 36 indoor units, and 7 for the 9<sup>th</sup> floor, with 59 indoor units. The actual installation included eight water-cooled VRF compressor units, four for the 10<sup>th</sup> floor with 27 indoor units, and four for the 9<sup>th</sup> floor, with 34 indoor units. The installation included only the first three phases of a seven-phase planned project, which was not continued as a result of budget constraints. Installation began in September 2010 and was completed in March 2011.

Existing terminal units were removed and were replaced with VRF fan coil units connected to the existing ductwork and diffusers that previously connected the terminal units to the conditioned spaces. The systems are installed with heating, cooling and heat recovery capability.

The VAV AHUs continue to provide conditioning to the areas not equipped with VRF fan coil units, and provide outdoor ventilation (mixed with conditioning supply air) to the fan coil units.

## ENERGY IMPACTS

The energy benefits of this VRF retrofit as originally planned could have included reduced fan energy, improved cooling efficiency, added heat recovery and reduced energy for outside air ventilation. As a result of the use of ice storage at the site, and incomplete installation of the VRF system, these benefits are not fully realized.

### *Fan Energy*

If fully implemented, the fan energy of the main air handlers could be reduced through several mechanisms.

Fan power is partially driven by the static pressure, the resistance to air movement, through the air distribution system, including the air-handler unit, into and through the ductwork, the terminal units for VAV systems, and the diffusers that deliver air into the space. The highest static pressure occurs on at least one pathway of ductwork and other components to the space. Reducing air flow through the system reduces the static pressure and the fan power, if ductwork, the fan, and other system components remain the same size. Fan power varies in direct proportion to the quantity of air delivered by the fan when the fan speed remains constant. Fan power is reduced even more with reduction of air flow with fans with variable-frequency drives, such as in the VAV systems at the Moakley Courthouse.

If the VRF system were fully implemented, the air flow of the central units would be reduced to just meet outside air requirements. The static pressure experienced by the air-handler fans would be reduced both by the reduced air flow and by the removal of the terminal units, and the static pressure setpoint the fan is controlled to overcome, could be lowered. The fan coil unit fans would overcome their own internal static pressure and that of the downstream ductwork and diffusers.

In the actual installation, some of the VAV boxes remained in place and the maximum actual static pressure at the AHUs may not have been reduced significantly by removal of terminal units. If the terminal unit(s) on the highest static air flow pathway were not replaced with VRF fan coils, which add no static pressure to the central fans, then central fan power was not reduced by removal of terminal units. However, some reduction in static pressure for reduced supply air flow through the ducts and other system components did probably occur.

### *Cooling and Pumping Energy*

Cooling with water-cooled condenser VRF units could theoretically save energy relative to cooling with the water-cooled chillers. Energy used for chilled-water pumping is reduced. Condenser-water pumping and

cooling tower operation continue because the VRF compressor units are served by that same equipment. There should be an increase in associated daytime energy use (kWh) and peak demand (kW) because the VRF runs during the occupied hours, unlike the chillers, which normally only operate during the unoccupied hours.

The rated IEER of the most common size of the VRF condenser units installed is 17.0, or 0.71 kW/ton. The nominal cooling efficiency of the chillers is 0.6 kW/ton. However, the chiller is producing 27 °F brine for ice storage, which is typically less efficient than producing normal chilled water around 44°F. With 60 feet of head, and assumed 15 °F delta-T, the chilled water pump would add about 0.024 kW/ton at full load, but the chilled water pumping system is controlled by a VFD and will normally run at a fraction of that power. Even allowing for the pumping energy, the chiller efficiency could be significantly lower when making ice than the nominal efficiency, and still be more efficient in cooling than the VRF system.

Ice is normally produced during unoccupied hours when demand charges are low. Because ambient temperatures are low during these hours, the chilled water system will operate at higher efficiency relative to operating during the day. The chillers can also operate during the off hours near or at their ideal part load efficiency, because the load on the chiller is practically constant when making ice. Only in high cooling demand periods will the chillers be forced to operate at loads outside of the ideal part-load efficiency. The chiller operating efficiency may even be higher than if the chillers were operating at normal chilled water temperatures during the day. Additional energy is used with the ice storage system for pumping, and to make up losses from the ice storage system. In any case, because of reduced demand charges, the energy cost of the chilled water operation per unit of cooling are intended to be and probably are lower than they would be if operating conventionally during the day.

### *Heat Recovery*

The VRF system allows refrigerant heat recovery. If there are significant periods when some spaces served by the VRF system are in cooling and other spaces are in heating, then heat recovery occurs. Boston experiences cold outside temperatures seasonally and because the fan coil units are located in both the core and interior, there is opportunity for heating and cooling and heat recovery to occur together.

Potential heat recovery is reduced relative to the plan because of the reduced number of fan coil units installed.

### *Outside Air*

If the project were completed, the VAV AHUs could be converted to operate solely as DOAS units. Because the AHUs now serve areas partially served by VRF fan coils, energy savings benefit from a DOAS type operation may be reduced relative to a full installation of VRF fan coils. The air flow to the fan coil units is reduced to 30% of the maximum air flow that was provided to the corresponding terminal units, reducing fan power as described above. However, the air flow to the fan coil units will be supplied at the supply air temperature of the main system; if a zone served by a fan coil unit calls for less cooling, even at 30% of the original maximum air flow, some VRF fan coil units may end up switching into heating mode to provide

reheat. A VRF system with a DOAS unit does not normally need to provide any reheat, assuming the DOAS air temperature is controlled appropriately.

### *Heating Energy*

The AHUs and the VRF units both utilize the boilers as the primary heat source. The VRF compressor units draw heat from the hot water loop, which the boilers replace. No heating energy savings apart from heat recovery described above should occur. With air-cooled VRF systems, heating is provided by the VRF compressors operating in a heat pump mode, which can save energy relative to other heat sources.

If the original VRF plan is completed, the potential fan, cooling and heating energy recovery, and outside air energy savings may be fully realized. If net cooling efficiency of the VRF systems is lower than for the chiller plant, then the overall HVAC energy savings will be diminished.

If the VAV AHUs are operating effectively as DOAS units, adding exhaust energy recovery to these AHUs could provide additional savings. A run-around loop with coils in the exhaust air stream, and in the return air stream would be more feasible than adding an energy recovery wheel. Adding an energy recovery wheel would require a lot of space, and a crane to move a standalone energy recovery unit to the roof. An energy recovery retrofit is worth considering for AHU26 and 27, even if the VRF plan is not achieved and for the other AHUs that are not part of the VRF because of the significant amount of heating energy required to condition outdoor air in Boston.

Estimating the total energy savings for this project is difficult because there are no energy modeling tools that could directly capture the water-cooled VRF system operating in heat recovery mode both on the refrigerant and water-side and interacting with the VAV systems operating partially as DOAS units and partially for space conditioning. Substantial external calculations and simulation approximations would be required, and the results would have a high degree of uncertainty.

## **B. OTHER PROJECT EXAMPLES**

Four VRF projects in the Northwest are briefly described in Table 3 to illustrate the variety of projects being developed. These projects include retrofit and new construction.



**Table 3: Example VRF Projects**

Project	Building	VRF Implementation	Benefits	Source
Mercy Corp Portland, Oregon	Renovation of the 42,000-ft <sup>2</sup> historical 1892 Packer-Scott Building plus addition of 40,000 ft <sup>2</sup> . The building is primarily office space.	10 outdoor VRF compressors with energy recovery. DOAS system with variable supply flow, dedicated variable flow fans at the zones controlled by CO <sub>2</sub> sensors in many zones.	HVAC energy performance was not modeled separately. Whole building energy usage is measured at 36 kBtu/ft <sup>2</sup> versus modeled usage of 38 kBtu/ft <sup>2</sup>	New Buildings Institute 2011 Schnare 2011
Jamestown S’Klallam Tribe Medical Clinic Sequim, Washington	New 33,000-ft <sup>2</sup> medical clinic	78-ton VRF system with heat pump and heat recovery operation. DOAS with energy recovery.	Estimated savings 41,400 kWh per year. Cost \$2/ft <sup>2</sup> more than VAV alternative.	BPA, 2012b
Lewis County PUD Chehalis, Washington	Renovation of 28,000-ft <sup>2</sup> office building while building remained open.	56-ton VRF heat pump system with a DOAS using existing ductwork. Replaces old heat pumps. Selected over VAV alternative.	Estimated savings 25,000 kWh/year. Incremental cost, \$75,000. Better heating comfort –formerly used a lot of electric space heat.	EES Consulting 2011, BPA 2012c
Lamb Building Eugene, Oregon	St. Vincent de Paul 37,500-ft <sup>2</sup> 4-story affordable housing building.	VRF with heating, cooling, and heat recovery.	Modeled savings of 80,000 kWh	BPA, 2012d

## V. Opportunity Assessment Results and Findings

### A. PROJECT ECONOMICS

GSA is under multiple mandates to achieve energy savings, including most recently E.O. 13514 (GSA 2010). The primary driver in industry for energy efficiency is typically reduction of operating cost at an affordable initial cost and reasonable payback. This section discusses the potential energy savings and energy cost savings, the initial cost of VRF projects, and simple payback. Because of the limited information available, this analysis should be used to understand the potential of VRF technology for the GSA portfolio as a whole, and to help identify the types of buildings that may be good candidates for VRF technology. Individual projects should be evaluated independently.

### HOW VRF SYSTEMS CAN ACHIEVE ENERGY SAVINGS

VRF systems are marketed as offering extraordinary improvements in energy efficiency including savings of between 30% and 60% in HVAC energy usage compared to a range of other HVAC systems. This is based on improved efficiency in all three areas of the HVAC system energy usage.

- Cooling efficiency. AHRI product certifications include many VRF products with IEER ratings in the 17 to 20 IEER range (AHRI 2012). This is 0.6 to 0.7 kW/ton. There are selections in the 13 to 15 IEER ranges that will not achieve the full advertised savings relative to other code compliant unitary equipment. Cooling savings relative to conventional equipment can be estimated by examining minimum efficiency requirements in ASHRAE Standard 90.1 2010 (ANSI/ASHRAE/IESNA. 2010).
  - Unitary AC –ASHRAE 90.1-2010 minimum efficiency is from 9.6 to 11.4 IEER, depending on cooling capacity. The VRF systems that achieve the typical range of IEER can save about 50% cooling energy.
  - Air-cooled chiller -ASHRAE 90.1-2010 minimum integrated part-load value (IPLV) is 12.5 to 12.75 IPLV; the VRF could save about 30% cooling energy.
  - Water-cooled chiller – ASHRAE Standard 90.1-2010 minimum IPLV ranges from 0.4 to 0.63 kW/ton. The VRF selection will have to be at the top of its IEER range to approach these efficiencies. Chilled and condenser-water pumps (and cooling tower energy usage, but this equipment will typically include variable-speed controls to comply with energy codes) save cooling energy alone relative to water-cooled chillers. The cost of water used in cooling towers can help offset an energy cost increase if the VRF system operates at lower average cooling efficiency than the chilled water plant.
- Heating efficiency. AHRI product certifications include air-source VRF units with COP values that are typically 3.2 to 3.5 with some product lines achieving values of 4.0 or higher at the 47°F dry-bulb, 43°F wet-bulb rating condition.
  - Conventional heat pumps are required to achieve 3.2 to 3.3 COP under the same rating conditions. 0% to 25% heating savings may be possible.

- Relative to a single-zone gas furnace, boiler or VAV electric reheat, the heating savings is around 75% for the VRF.
- Fans. The indoor fan coils can be ducted or non-ducted and static pressure might range from 0.5 to 1.5 in. w.g. A portion of the fan system will still be higher to deliver ventilation air.
  - Conventional constant-air volume (CAV) systems may have static pressure between 1.5 to 4 total inches of static, allowing 25% to 75% savings.
  - VAV units may have even higher static pressure, but operate at 50% or lower power most of the time in part-load fan speed operation. VRF fans should be able to achieve significant fan savings.

VRF manufacturers are increasingly targeting larger buildings that would typically use chilled water systems in the U.S., whether air-cooled or water-cooled, as the primary cooling source. These systems are most often coupled with VAV air handlers. Water-cooled chillers will typically have higher average part-load efficiency than VRF systems. However, water-cooled chiller systems also have pumps, cooling towers and air handlers, which also consume energy. **Figure 6**, provided by a manufacturer, shows a hypothetical comparison with system efficiency at a range of part-load conditions. This compares a VRF system with a chilled water system that includes VFD equipped chilled water pumps, and a VAV AHU. Although the chiller is more efficient than VRF system, the VRF system efficiency is higher than the combined efficiency of the chiller plant (Doppel 2012). This is a representative example; specific projects need to be examined on a case-by-case basis.

**Figure 6: Part Load Efficiency of VRF (VRV) and Water-Cooled Chiller and Air-Handler System**

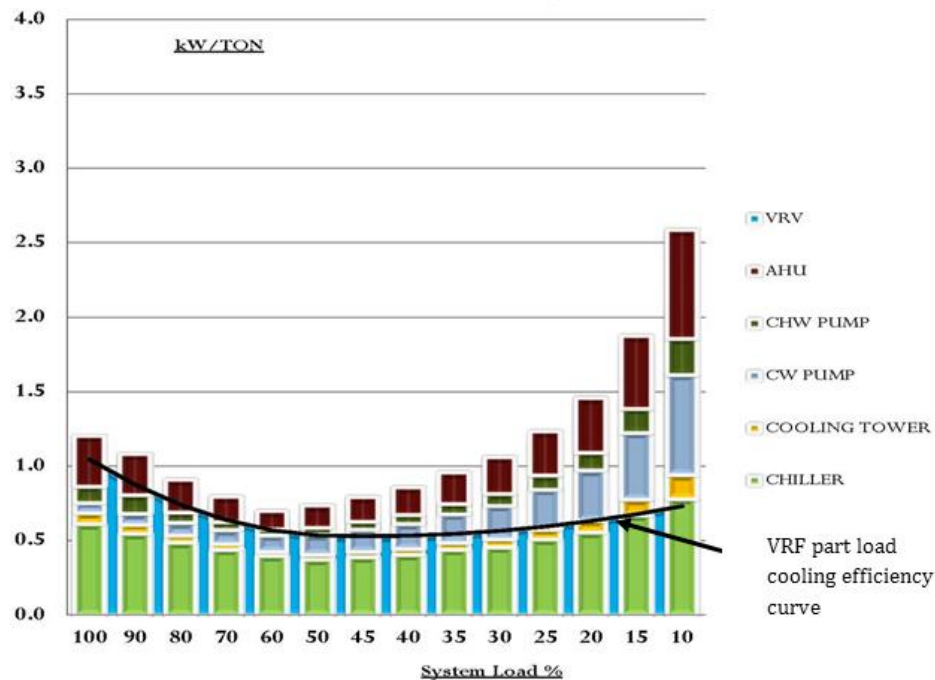

(Included by permission from Daikin)

## SOURCES OF ENERGY SAVINGS INFORMATION AND UNCERTAINTY

Proof of energy savings from VRF systems is limited. This review identified only one case of measured savings isolated to building changes in HVAC systems. As described below, only a sampling of monthly results was provided. Other savings information provided in this report includes energy simulation results, and savings values in publications or presentations often attributed to manufacturers or from recent interviews. Currently, none of these savings values have been fully calibrated to match real world performance.

Simulation results are affected by the limitations of the simulation software. There are four main simulation tools that are used to analyze VRF systems: eQuest, EnergyPlus, EnergyPro and Trane Trace.

- eQuest, based on DOE 2.2, is a broadly used, free but full featured, energy simulation tool. eQuest does not have a built in algorithm for VRF, and several energy modelers have developed various methods for approximating VRF systems, including post-processing of results to estimate heat recovery savings.
- EnergyPlus is the current simulation tool that DOE supports. It is currently difficult and time intensive to use relative to eQuest, and does not have a broadly used comprehensive user interface like eQuest. Energy Plus includes VRF algorithms for cooling, and cooling and heating operation but not heat recovery. A heat recovery module is in development. Research is also underway to calibrate EnergyPlus to real world VRF operation (FSEC 2012).
- Energy Pro, based on DOE-2.1e is primarily used for compliance with California's energy code, Title 24. Only Energy Pro claims to fully model VRF systems with the heat recovery option; however, recent research suggests it does not capture changes in performance when the unit operates in heat recovery (FSEC 2012). Energy Pro also includes calculation of the impact of the length of the refrigerant lines and head pressure at the compressor on energy usage, which none of the other tools include. The operation of the VRF model and underlying assumptions and calculations are not readily accessible to the user.
- Trane Trace does have an algorithm for VRF that results in lower savings than Energy Pro. The Trane Trace model details and operation are also not readily accessible.

Reported and potential energy savings vary based on the HVAC baseline system the VRF system is compared to. Most of the available information about VRF energy savings is in comparison to conventional HVAC systems. This is problematic because a desire to minimize energy cost is often a major criterion in projects that consider VRF systems, and a conventional system that uses a typical amount of energy may not be considered an option. The relevant comparison in some projects may be to determine which high-performance alternative best fits the project and is most cost-effective. Other energy-efficient HVAC alternatives that could be considered include radiant systems, ground-source heat pumps, chilled beams and high-efficiency versions of conventional systems such as packaged CAV and VAV, or VAV with chilled and hot water. Conventional systems can be optimized with efficient motors, pumps, variable-speed controls, DOAS with energy recovery, demand-controlled ventilation, and for VAV using a coordinated

strategy to minimize reheat. There are studies that compare VRF systems with ground-source heat pumps indicating that ground-source heat pumps save more energy than VRF systems (Hong and Liu 2010).

The energy savings information collected for this study did not always provide a complete description of the baseline systems, but these appeared to be existing systems or new systems that just meet energy codes or standards. The available information is categorized into four baseline system types: chilled water systems, packaged VAV systems, packaged constant volume systems, and package air-source heat pumps.

## **POTENTIAL ENERGY SAVINGS RESULTS**

Using the potential savings values from the various sources, possible percentage energy savings were estimated. Energy cost savings percentages were also estimated. This method results in a rough approximation of the energy and energy cost savings potential across a portfolio of buildings in many climates. Specific savings will vary with building type, other characteristics of the building (such as lighting, and building envelope), and climate location.

### *Independent Energy Simulation Results*

Only one independent energy simulation analysis was identified during this project (Hart and Campbell 2012). This analysis used eQuest, with VRF performance curves developed by the simulation team from a manufacturer's published performance data. Two basic building models were considered. A small office model compared VRF with a gas heat RTU, and a medical office model compared VRF with a VAV electric reheat option and an air-to-air heat pump option. The study looked at eight climate location cities. Some selected high-level results from the presentation are provided in Table 4 of this report for four of these locations, identified as ASHRAE 90.1 California (climate zone 3b), Northwest (4c), Midwest/Northeast (5a), and Southeast (4a).

Results presented in Table 4 are for HVAC energy only. Total HVAC energy usage and energy savings differ significantly, as does the energy savings by usage category (heating, cooling and fans). Energy cost savings are presented as well.

**Table 4: Office Energy Model Results, HVAC Energy Only (Hart and Campbell 2011)**

HVAC System Type	California	Northwest	Midwest/Northeast	Southeast	Average Savings
Energy usage, kBtu/ft <sup>2</sup>					
RTU with economizer	13.5	12	21	17	
VRF with heat recovery	9.5	7.5	10	10.5	
Percent savings	30%	38%	52%	38%	39%
Energy cost, \$/ft <sup>2</sup>					
RTU with economizer	\$0.54	\$0.18	\$0.59	\$0.51	
VRF with heat recovery	\$0.39	\$0.14	\$0.44	\$0.33	
Savings	\$0.15	\$0.04	\$0.15	\$0.18	
Percent savings	28%	23%	26%	35%	29%

(Reprinted by permission, Hart and Campbell 2011)

A summary of observations on the Table 4 model results are given below:

- Average HVAC energy savings are 39% for the VRF system compared to the RTU with economizer.
- Average HVAC energy cost savings are 29%. This value is about 75% of the energy savings percentage because there is a shift in heating energy source from gas to electricity, sometimes referred to as fuel switching. The VRF system is much more efficient in its use of the energy delivered to the site from the utility than the RTU gas furnace, but even with greatly reduced heating energy usage, the remaining heat is now provided by electricity, which costs substantially more per equivalent unit of energy.
- On a percentage savings basis, the results are reasonably consistent across the climate regions. This is useful for understanding the aggregate savings potential for all buildings and for GSA's portfolio.
- The heating energy savings and energy cost for Midwest/Northeast is much greater than any of the other climates – not surprising given the cold temperatures. VRF operates as a heat pump and compared to VAV with electric reheat, other electrical resistance heating, gas furnace and gas boilers, offers a very large reduction in heat energy.
- The Northwest energy cost savings are by far the smallest because of relatively low cost of energy (energy savings are lower in California, but energy cost savings are higher based on the higher cost of energy). The cooling energy, not shown in the table, actually increases because the baseline includes an air-side economizer. Seattle, Washington is the climate location for this and has a large number of economizer hours. This type of climate is not a good application for VRF energy savings. Energy savings in California are lower than in the Northwest, but energy costs are higher because of higher energy costs.
- The medical clinic model shows similar results in terms of consistency of savings across climate regions with much higher savings overall compared to the RTU case. The VAV system has substantial

electric reheat so there is substantial heating savings from application of the VRF, which has no reheat. Reheat may be reduced in reality with better controls than in the model.

- The average savings of the VRF system versus the packaged VAV system is 63% for HVAC energy and 62% for energy costs.
- The average savings of the VRF system versus the air-source heat pump system is 62% for energy costs. The average energy savings is not shown in the presentation this information comes from.

### Manufacturer Energy Simulation Results

One energy study by LG, a manufacturer of VRF systems, covers HVAC systems in larger office buildings not covered in the Hart study (LG 2011). This is presented in a report format online and provides significant detail about the assumptions and methodology of the simulation, which appear reasonable. Energy Pro was used. A simplified large office model, 6 stories and 133,500 ft<sup>2</sup>, is used to compare three ANSI/ASHRAE/IESNA Standard 90.1-2007 baseline HVAC systems to a VRF system with heat recovery. The baseline systems are: 1) a water-cooled chiller with VAV and electric reheat; 2) a DX CAV RTU with gas furnace; and, 3) a WSHP with boiler and cooling tower (ANSI/ASHRAE/IESNA 2007). Energy cost/ft<sup>2</sup> values are extracted and listed in Table 5. As with the results in Table 4, there is reasonable consistency in the percentage savings results across climates.

**Table 5: Large Office Comparison of Three HVAC System Types with VRF, HVAC Energy Only**

		Miami	Phoenix	Atlanta	New York	Chicago	Average
VRF with heat recovery	Energy Cost, \$/ft <sup>2</sup>	0.64	0.68	0.6	0.96	0.74	
Chilled water, VAV electric reheat	Energy Cost, \$/ft <sup>2</sup>	1.07	0.93	0.93	1.63	1.15	
	Savings, \$/ft <sup>2</sup>	0.43	0.25	0.33	0.67	0.41	
	Savings,%	40%	27%	35%	41%	36%	<b>36%</b>
RTU, gas heat	Energy Cost, \$/ft <sup>2</sup>	1.18	1.18	1.22	1.73	1.84	
	Savings, \$/ft <sup>2</sup>	0.54	0.5	0.62	0.77	1.1	
	Savings,%	46%	42%	51%	45%	60%	<b>49%</b>
Water-source heat pump	Energy Cost, \$/ft <sup>2</sup>	0.73	0.74	0.73	1.15	0.81	
	Savings, \$/ft <sup>2</sup>	0.09	0.06	0.13	0.19	0.07	
	Savings, %	12%	8%	18%	17%	9%	<b>13%</b>

### Average Energy Savings Potential

The energy savings information from the two simulation studies highlighted above and other sources is listed in Table 6. The average savings by system type are shown in the bottom two rows of the table. For systems with electric heat, the energy savings and the energy cost savings are essentially the same in the data examined in this study.

**Table 6: Potential HVAC Only Energy Savings from VRF Systems Compared to Other Systems**

Chilled Water, VAV	Packaged VAV	Packaged CAV	Air-Source Heat Pump	Water-Source Heat Pump	Notes	Source
	62%	39%	49%		Independent modeling study. Values shown are averages for 4 climate locations, California, Northwest, Midwest/Northeast, and Southwest. See description in text with Table 4.	Hart and Campbell 2012
36%		49%		13%	Manufacturer modeling study. Values are average savings relative to VRF for five climates for a large office building. See description in text at Table 5.	LG 2011
34%					Average of three savings values. Identified as from simulations or literature review.	Goetzler 2007
33%	29%		33%		Multiple sources - literature, manufacturers' information.	EES Consulting 2011 - from Aynur 2010, Amarnath and Blatt 2008
	43%		23%		Average of Mitsubishi simulations for multiple buildings in Seattle, WA.	EES 2011
		55%			LG energy study, generic small retail store, average of multiple climates.	LG 2012
34%	45%	48%	35%	13%	Average energy savings and energy cost savings with electric heat source.	
26%	32%	36%	NA	NA	Average energy cost savings with gas heat – see text.	

The average energy cost savings when switching from gas heat to electric heat for the portion of the heating provided by the VRF systems is roughly estimated and shown in the bottom row in Table 6. Based on the simulation results shown in Table 4, the average energy cost savings percentage when switching from gas to electric is about 75% of the savings going from electric heat to electric heat. This is the result of the higher



cost of electricity relative to natural gas, which offsets part of the savings from reduction in energy usage. This relationship will vary by utility rates and by the proportion of heating energy to other energy uses (as seen in Table 4) and should be evaluated separately for individual projects.

Percentage energy cost savings vary by the HVAC system that VRF is compared to. An average energy cost savings value of 34% is estimated for switching to VRF rather than packaged VAV and CAV with gas heat. 34% is also used for switching from air-source heat pumps. Relative to VAV with electric reheat, average energy cost savings is estimated as 45%.

VRF systems may also be used in larger projects that would otherwise often select chilled water VAV systems in the U.S. Estimating the chilled water savings is problematic because it is not clear from some of the sources of information if the VAV systems or VRF systems are air-cooled or water-cooled. The average energy cost savings of VRF is estimated as 34% compared to VAV with chilled water and electric reheat, and 26% compared to VAV with chilled water and hot water reheat, but this a broad estimate that can't distinguish between air-cooled and water-cooled systems.

### *Energy Savings in GSA Buildings*

To understand the possible impact of VRF systems across a range of GSA's existing and new buildings, the potential savings percentage is applied to GSA energy usage profile information. Table 7 shows total energy usage data per ft<sup>2</sup> (known as an energy use index (EUI)) was provided for pre-1980 and all GSA buildings<sup>5</sup>. Data for all regions is used in the savings analysis in this report. The regional data can be used to roughly scale results for specific regions. The low and high values are the minimum and maximum averages from the whole set of values. There are GSA buildings with energy usage that falls outside this range of values.

The energy usage information from GSA does not break out HVAC energy usage, which is needed to apply the energy cost savings potential HVAC only percentage savings values identified in Table 6. An estimate of the GSA HVAC energy usage is developed by comparison with Commercial Buildings Energy Consumption Data (CBECS) and Pacific Northwest National Laboratory (PNNL) energy simulation results that were used in the development of ASHRAE Standard 90.1-2010. Table 8 shows this comparison and the % savings for HVAC. An average of the percentage HVAC energy usage of heating, cooling and fans is applied to the GSA energy usage data.

---

GSA energy usage data was provided by M. Kaiser (GSA) to B. Thornton (PNNL) in an e-mail November 16.

**Table 7: GSA Building Average Annual Energy Usage**

Region	kBtu per ft <sup>2</sup>	
	All Years	Pre-1980
All	61.1	60.2
Region 1	56.8	58.2
Region 2	75.6	79.0
Region 3	66.1	60.3
Region 4	51.5	48.8
Region 5	65.4	65.7
Region 6	61.4	52.3
Region 7	49.7	49.3
Region 8	67.0	66.6
Region 9	52.4	54.7
Region 10	50.8	48.1
Region 11	72.6	77.0
Low	49.7	48.1
High	75.6	79.0

The energy usage data from CBECS in the table is site energy usage in combined fuel units of kBtu/ft<sup>2</sup>, not source energy. Energy usage data is extracted for the following three categories:

- 1) all buildings,
- 2) buildings constructed before 1980, and
- 3) buildings constructed between 2000 and 2003.

The PNNL ASHRAE 90.1 simulation models in Table 9 are aggregated results for 16 building prototype models run with 15 climate zones in the U.S. to represent typical energy usage for all buildings in the U.S. Two cases are shown, one with buildings modeled to meet ASHRAE Standard 90.1-2004, and one with buildings modeled to meet ASHRAE Standard 90.1-2010. As 90.1-2010 becomes commonly applied, or equivalent requirements for federal buildings (to the extent not already required) the average building EUR will probably fall.

The average energy usage for all buildings has very high heating energy relative to the newer building that have EUIs closer to the range of GSA buildings. HVAC percentages are not shown for all CBECS buildings. The energy usage from CBECS for pre-1980 is 125 kBtu/ft<sup>2</sup>, and is not shown because this is nearly twice the GSA average.

GSA has a portfolio that is significantly more energy efficient than the typical building prior to 2003, particularly for buildings prior to 1980. The economic analysis in this report is conservative for the range of typical buildings and some buildings in GSA’s portfolio, and these should be evaluated separately.

**Table 8: HVAC Energy Usage Share of Total Energy Usage**

Energy Usage Type	All Buildings, CBECS 2003, kBtu/ft <sup>2</sup> /yr.			All Buildings, Standard 90.1, kBtu/ft <sup>2</sup> /yr.				Average Usage %
	All Years	2000-2003	Usage, %	90.1-2004	Usage, %	90.1-2010	Usage, %	
Total	91.0	81.6		73.9		55		
Heating	33.0	19.4	23.8%	18.1	24.5%	9	16.4%	21.5%
Cooling	7.2	8.8	10.8%	9.5	12.9%	6.9	12.5%	12.1%
Fans	6.1	5.9	7.2%	7.6	10.3%	5.2	9.5%	9.0%
HVAC <sup>1</sup> , kWh/ft <sup>2</sup>	4.9	4.9		5.5		3.8		
HVAC, therms/ft <sup>2</sup>	0.33	0.17		0.16		0.08		

*Energy Cost Savings in GSA Buildings*

Table 9 applies these percentage proportions of HVAC energy usage categories to the GSA data, calculates energy cost per ft<sup>2</sup>, and converts the kBtu/ft<sup>2</sup> data to kWh/ft<sup>2</sup> and therms/ft<sup>2</sup>. GSA provided average natural gas rates paid for their buildings by region and all regions. The average, minimum and maximum rate are used in Table 9. A range of blended electricity rates (including demand) is used \$0.08, \$0.10, and 0.16/kWh. The values are rounded from the lowest state, national average, and highest (excluding Hawaii) state average retail prices from 2011 from the Energy Information Agency (EIA 2012). GSA information on electricity rates is not available. The calculation of energy in utility units includes information in the CBECS data, which shows about 10% heating comes from electricity, and 90% comes from fossil fuels (mostly gas) (CBECS 2003). Heating total kBtu/ft<sup>2</sup> is allocated to kWh and therms in these percentages. The proportion of heating fuel sources in GSA buildings was not available.

**PROJECT COSTS**

The cost of a VRF system varies depending on specific building characteristics. More important than total initial cost is incremental cost for the VRF system relative to the alternatives that could be applied.

Table 10 provides several values for the initial cost of a VRF system, varying from \$16.50/ft<sup>2</sup> to \$33.00/ft<sup>2</sup>. The table also shows values for the incremental cost of VRF systems compared to conventional HVAC systems. These values include both percentage increase values, and incremental cost/ft<sup>2</sup> values for VRF systems relative to other system types, and are drawn from multiple sources including publications, manufacturers’ data, industry experience, and costs reported from actual projects. The bottom row of the table includes average incremental costs/ft<sup>2</sup>; the notes explain the calculations to combine the percentage values and costs/ft<sup>2</sup>. These costs include new building projects, and major renovations to effectively new

**Table 9: Estimated VRF Energy Cost Savings**

Energy Usage and Cost	GSA Portfolio Regional Average EUI, kBtu/ft <sup>2</sup> /yr.			Standard 90.1-2010
	Minimum	Average	Maximum	
Total Energy Usage, kBtu/ft <sup>2</sup>	48.1	60.7	79	55
Heating	10.4	13.1	17.0	9
Cooling	5.8	7.3	9.5	6.9
Fans	4.3	5.5	7.1	5.2
HVAC, kWh/ft <sup>2</sup>	4.0	5.1	6.6	3.8
HVAC, therms/ft <sup>2</sup>	0.09	0.12	0.15	0.08
HVAC energy Cost, \$/ft <sup>2</sup> \$0.08/kWh, <b>VRF 34% energy cost savings, \$/ft<sup>2</sup>,</b>	\$0.32  <b>\$0.11</b>	\$0.41  <b>\$0.14</b>	\$0.53  <b>\$0.18</b>	\$0.36  <b>\$0.12</b>
HVAC energy Cost, \$/ft <sup>2</sup> \$0.10/kWh, <b>VRF 34% energy cost savings, \$/ft<sup>2</sup>,</b>	\$0.41  <b>\$0.14</b>	\$0.52  <b>\$0.18</b>	\$0.67  <b>\$0.23</b>	\$0.45  <b>\$0.15</b>
HVAC energy Cost, \$/ft <sup>2</sup> \$0.16/kWh, <b>VRF 34% energy cost savings, \$/ft<sup>2</sup>,</b>	\$0.64  <b>\$0.22</b>	\$0.80  <b>\$0.27</b>	\$1.05  <b>\$0.36</b>	\$0.71  <b>\$0.24</b>

VRF systems. Some of the sources did not clearly identify which. New building incremental costs set a ceiling on acceptable costs. Renovations with VRF that have a higher incremental cost than the “average” costs presented here will generally not be cost-effective. These values provide a rough basis for comparison with the potential savings; actual costs should be determined on a project-by-project basis.

The incremental cost information does not include incremental costs compared to aggressively energy-efficient alternative HVAC alternatives, and may not include any alternatives that would meet the requirements of ASHRAE Standard 90.1-2010.

There are additional cost considerations that may affect the apparent incremental costs.

- Controls costs should be evaluated, e.g., if the VRF system can provide an energy management system and, if that is part of the project requirements and an alternative set of HVAC equipment does not include such a system, the cost of that system should be added to the alternative cost.

- For new buildings, will VRF lower floor-to-ceiling heights, or reduce structural or electrical costs?
- Will additional leasable space be freed up by reducing mechanical room or duct shaft space?
- Costs to provide adequate outdoor air need to be accounted for with any alternative.

**Table 10: Incremental Cost of VRF Systems Including New Construction and Retrofit Projects**

VRF Base Cost	Chilled Water VAV	Packaged VAV	Packaged CAV (including RTUs)	Notes (source information did not always identify if savings are for new construction or retrofit)	Source
	Incremental Cost Relative to VRF				
	0% to 22%			ASHRAE article, multiple sources	Goetzler 2007
	5% to 20%		30% to 50%	Published article, various sources	Amarnath and Blatt 2008
\$23.2/ft <sup>2</sup>		\$2.68/ft <sup>2</sup>		Office projects, two retrofit projects, contractor cost estimate	EES Consulting 2011
		\$2/ft <sup>2</sup>		Medical clinic, cost estimate, new construction	BPA 2012b
\$16.50/ft <sup>2</sup>		\$3.50/ft <sup>2</sup>		Community college mixed use, VRF retrofit actual cost compared to VAV estimated cost	BPA 2012c
\$33/ft <sup>2</sup>	\$0/ft <sup>2</sup>	\$6.5/ft <sup>2</sup>	\$12.0/ft <sup>2</sup>	Design build mechanical contractor. Original information provided was in total initial costs for new construction of the different system types.	Telephone conversation <sup>5</sup>
		25%		Manufacturer product manager, new construction	Telephone conversation <sup>6</sup>
			\$1.44 to \$2.60/ft <sup>2</sup>	Modeling study, incremental for new construction, source not provided	Hart and Campbell 2012
\$24.2 <sup>1</sup>	\$1.8 <sup>2</sup>	\$3.9 <sup>3</sup>	\$5.7 <sup>4</sup>	Average values, \$/ft <sup>2</sup>	

1. Average of three VRF cost estimates

2. Incremental cost such that the average VRF price of \$24.2 \$/ft<sup>2</sup> is 8% higher than for chilled water VAV. 8% is the average of 0%, 11% (from 0 to 22%) and 12.5% (from 5 to 20%).

3. Average of incremental costs provided in \$/ft<sup>2</sup> including the 25% value from Richardson, which is calculated to be an incremental cost of \$4.85 relative to the cost of a packaged VAV system.

4. Average of incremental costs provided in \$/ft<sup>2</sup>, including the 40% (average of 30-50%) value from Amarnath and Blatt, which is calculated to be an incremental cost of \$6.92/ft<sup>2</sup> relative to the cost of a packaged VAV system.

5. Telephone call with G. Pelsler, President (Hunter-Davisson) and Brian Thornton (PNNL), April 17, 2012.

6. Telephone call with C. Richardson, Product Manager (Daikin) and Brian Thornton (Pacific Northwest Laboratory), April 17, 2012.

## ECONOMIC RESULTS

Simple payback in years, initial costs divided by annual energy savings, is the most common and easiest method to evaluate the economics of energy-efficiency alternatives. In this case, the initial costs are the incremental costs of the VRF system relative to other HVAC system alternatives. Payback is not the only measure to consider, life-cycle cost analysis identifying differences in maintenance, replacement and other ongoing costs may reveal additional economically attractive opportunities. Life-cycle cost analysis is more involved and depends more on the specifics of the project and building. However, there are maintenance and operations costs associated with the fan coil units relative to alternatives that have little maintenance of the zonal equipment, and a generic approach to looking at these life-cycle costs is provided below. VRF systems are generally competitive when considering non-energy operating costs along with initial costs and energy savings.

### *Simple Payback*

Simple payback is calculated as the added initial cost of the VRF alternative compared to other HVAC options divided by annual energy cost savings.

Unitary rooftop equipment such as VAV and CAV DX equipment has a service life of 15 years (ASHRAE 2011). Definitive information on VRF system service life was not identified, and is assumed to be 15 years as well. So a maximum payback that would typically be considered is 15 years, and generally a much lower payback is preferred.

The results show that for the range of typical annual energy usage and energy costs of GSA's buildings, there are simple paybacks possible that are reasonable.

In Table 11 for VRF compared to VAV with hot water reheat and CAV with gas heat, paybacks are long as the incremental cost rises above \$2/ft<sup>2</sup> at \$0.18/ft<sup>2</sup>, the energy cost savings identified in Table 9 at GSA national average building energy usage of 60.7 kBtu/ft<sup>2</sup> and with GSA average gas and EIA average electricity costs per energy unit. For packaged VAV, the average added cost is \$4/ft<sup>2</sup> and the payback is 22 years shown in bold in Table 11. For CAV, with average incremental cost of around \$6/ft<sup>2</sup>, the payback is 33 years. Table 11 shows that GSA should look for VRF potential paybacks of 15 years or less in new projects or existing buildings where the incremental cost relative to VAV with hot water reheat or CAV with gas heat is estimated to be lower than \$4/ft<sup>2</sup>, and the actual or modeled energy usage for that building with the base case system types is higher than the average GSA building energy usage of 60.7 kBtu/ft<sup>2</sup>. In buildings with even lower incremental first cost, buildings with average or higher energy usage may see reasonable paybacks at average or lower energy usage.

**Table 11: Simple Payback for VRF versus VAV with Hot Water Reheat and CAV with Gas Heat**

Added Cost, \$/ft <sup>2</sup>	Energy Cost Savings, \$/ft <sup>2</sup>							
	0.10	0.14	<b>0.18</b>	0.22	0.26	0.30	0.34	0.38
1.00	10	7	6	5	4	3	3	3
2.00	20	14	11	9	8	7	6	5
3.00	30	21	17	14	12	10	9	8
<b>4.00</b>	40	29	<b>22</b>	18	15	13	12	11
5.00	50	36	28	23	19	17	15	13
6.00	60	43	33	27	23	20	18	16

In Table 12 for VRF compared to VAV with electric reheat paybacks are a little more attractive than in Table 11. The energy cost savings for the GSA buildings with 60.7 kBtu/ft<sup>2</sup> annual energy usage and with GSA average gas and EIA average electricity costs per energy unit is \$0.23/ft<sup>2</sup> shown in bold Table 12. The payback at average added cost of \$4.00/ft<sup>2</sup>, the payback is still 17 years, longer than the maximum of 15 years. The table shows that GSA should also look for VRF potential in new projects or existing buildings, where the incremental cost relative to VAV with electric reheat is estimated to be lower than \$4.00 per ft<sup>2</sup>, and the actual or modeled energy usage for that building with the base case system types is higher than the average GSA building energy usage of 60.7 kBtu/ft<sup>2</sup>. As with the other packaged HVAC systems, in buildings with lower incremental first cost, buildings with average or higher energy usage may see reasonable paybacks at average or lower energy usage.

**Table 12: Simple Payback for VRF versus VAV with Electric Reheat**

Added Cost, \$/ft <sup>2</sup>	Energy Cost Savings, \$/ft <sup>2</sup>							
	0.13	0.19	<b>0.24</b>	0.29	0.34	0.40	0.45	0.50
1.00	8	5	4	3	3	3	2	2
2.00	15	11	8	7	6	5	4	4
3.00	23	16	13	10	9	8	7	6
<b>4.00</b>	30	22	<b>17</b>	14	12	10	9	8
5.00	38	27	21	17	15	13	11	10
6.00	45	32	25	21	17	15	13	12

Chilled water VAV systems have similar potential simple paybacks, however the information available did not provide enough information from multiple sources to clearly distinguish the incremental cost and potential energy cost savings for air-cooled and water-cooled chillers, or air-cooled and water-cooled VRF systems.

Building characteristics that can lead to lower incremental costs include:

- existing buildings that are constrained for space and need additional or replacement ductwork to support a conventional alternative
- new buildings with HVAC requirements that are at least as stringent as 90.1-2010, making conventional system costs more than in the past; this will also result in lower energy cost savings
- new buildings where use of VRF systems will allow lower floor-to-floor height
- buildings where use of VRF systems will allow use of more floor area that would be unavailable because of space required for other HVAC system alternatives and ductwork
- buildings with control and monitoring requirements that can be at least partially met by the inherent capability of the VRF systems but that will need separate equipment and programming to be met with other HVAC system alternatives.

### LIFE-CYCLE COST ANALYSIS

This section presents an example life-cycle cost analysis (LCCA) of a VRF system compared to a VAV system with electric reheat, both as alternative retrofits into a hypothetical, medium-sized office building. This is one example LCCA comparison for VRF and another system; specific applications need to be evaluated individually. This example is intended to show the impact of increased maintenance cost and repair and replacement cost for the VRF system

The building is assumed to have sufficient room and flexibility to allow installation of either system. The example has initial costs and energy cost savings consistent with a 10-year simple payback. From Table 12, this is selected with an added initial cost for the VRF of \$3.00/ft<sup>2</sup> and a \$0.29/ft<sup>2</sup> energy cost savings, placing it modestly above GSA average energy usage, or above average electricity and gas costs. The \$3.00/ft<sup>2</sup> initial cost implies there are some cost advantages for the VRF, such as for reduced ductwork requirements, relative to the estimated average cost premium of \$4/ft<sup>2</sup>.

The building contains 48,000 ft<sup>2</sup> of office space, with a design cooling load of 120 tons (400 ft<sup>2</sup> per ton). Both the VAV system and the VRF system are assumed to include four 30-ton compressor units. The VAV systems are RTUs with electric reheat, and gas central heat, and include 10 terminal units per 30-ton RTU, each supplying 1,200 cfm for a total of 40 terminal units. The VRF system includes 15 2-ton, 800-cfm indoor fan coils per compressor unit for a total of 60 fan coils. Both systems include exhaust air energy recovery. The VRF system is assumed to have a DOAS using a CAV RTU with gas heat.

#### *Methodology*

The LCCA follows an approach and economic assumptions consistent with the FEMP approach. The calculations use present value (PV) formulas to bring all costs to their value in the present, and compare the difference between the present values of the alternatives being considered. Costs are all given in 2012 dollars. The discount rate is 3% and is a real rate that includes inflation. The LCCA parameters are shown in Table 13.



**Table 13: LCCA Parameters**

Parameters	Value	Source
Period of analysis, years	30	
Discount rate, Real	3%	
Inflation	0.9%	FEMP LCC parameters, (Rushing et al. 2011)
Energy cost escalation, source has 1.0% but using 0.9%, same as general inflation for simplicity	0.9%	
Overhead and profit, 30% replacement	30%	RS Means 2012
VAV savings, % below 1980 and older buildings	10%	Assumed
VRF savings, % below VAV alternative	45%	Table 6
Labor rate	\$55.30	RS Means 2012

### *Maintenance, Repair and Replacement*

The life-cycle cost analysis differs from simple payback because it considers operating costs other than energy. These additional operating costs include maintenance, repair and replacement. The VRF system has more maintenance than the VAV system for this analysis because of the large number of fan coils, which include filters and condensate trays. The VAV system has central equipment with more periodic maintenance, and includes VAV terminal units that require regular maintenance. Table 14 includes maintenance, and repair and replacement costs and the sources of the information.

The VRF system is assumed to remain more expensive than the VAV system, but by \$2 per ft<sup>2</sup> instead of \$3.00 per ft<sup>2</sup> used for the initial added cost. Given the trends in codes and standards and technical advancement to curb climate change, it seems quite likely that by 2027, the end of the equipment useful life if installed this year, VAV RTUs will be required to include variable-speed compressors and other advancements to stay competitive and meet codes and standards. Standard 90.1-2010 added more complex requirements for VAV system controls that will need regular maintenance to keep in operating order. In addition, the VRF compressor units are a lot easier to remove and replace than the VAV units. The cost is given as a total. Labor is assumed to be about the same between the two replacements.

### *LCCA Results Summary*

The results of this LCCA are shown in Table 15. It shows that for the example case presented, the VRF system has a lower 30-year life-cycle cost than a comparable VAV system. However, it also shows that increased annual maintenance costs of \$0.023 offset the annual energy cost savings of \$0.29/ft<sup>2</sup>. There are also added repair replacement costs over the 30-year period. The total annualized LCC savings for the VRF system are \$0.087/ft<sup>2</sup>.

**Table 14: VRF and VAV Maintenance, Repair and Replacement Costs**

Cost Items	Frequency years	Qty.	Labor Hours, each item	Labor Cost	Material Cost, each	Material cost, total	Total Cost with OH&P	NPV	Sources of Information
<i>VAV System</i>									
Economizer maintenance	1	4	0.83	\$184	\$0	\$0	\$240	\$4,697	Note 1
Terminal unit maintenance	1	40	0.93	\$2,066	\$47	\$1,880	\$2,686	\$52,643	Note 2
Repair terminal units, 10 and 25 years	10	40	1.2	\$2,654	\$0	\$0	\$3,451	\$4,216	RS Means Facilities and Repairs, 2004 for labor hours and base for material costs which are inflated 2% per year since 2004.
Refrigerant replacement	10	4	3.3	\$730	\$88	\$290	\$1,326	\$1,620	RS Means Facilities and Repairs, 2004
Subtotal NPV								\$63,176	
<i>VRF System</i>									
Fan coil filter change, 2/year	0.5	60	0.25	\$1,659	\$5	\$600	\$2,937	\$57,561	RS Means 2012
Check/clean condensate system	1	60	0.25	\$830	\$0	\$0	\$1,078	\$21,136	Butler 2004 for labor hours
Fan coil motor replacement, cost at life, 10 and 25 years	10	60	3.1	\$10,286	\$140	\$8,400	\$24,292	\$29,677	1/4 hp ECM motor from Small ECM motor presentation (Heschong Mahone Group et al. 2010)
Replace refrigerant	10	4	3.3	\$730	\$176	\$580	\$1,703	\$2,080	Same source as terminal units under VAV. 2.5 times normal refrigerant materials cost for VRF and DOAS compressor unit.
Incremental replacement	15	4						\$82,286	Note 3
Subtotal NPV								\$192,740	

1. Economizer maintenance - Verification that the economizer opens, closes, and appears to function properly using cold spray or ice on the outside air sensor. Estimated 45 minutes. Since entire economizer is assumed to be replaced, not repaired, at typical life, assuming motor replacement costs are accounted for. Adding 5 minutes maintenance per 1000 cfm above 1000 cfm. Source is PNNL staff experience in utility incentive programs and commissioning firm.

2. Terminal unit maintenance, *RS Means Facilities and Repairs, 2004*, includes access, verifying controls connections, tighten arm on motor output shaft, verify actuator is operating, lubricate.

**Table 15: Life Cycle Cost Analysis Results for a VRF System Compared to a VAV System**

Costs	Cost, \$/ft <sup>2</sup>	First Cost	PV	PV/ft <sup>2</sup>
Initial cost				
VAV	\$21.0	\$1,008,000	\$1,008,000	\$21.0
VRF	\$24.0	\$1,152,000	\$1,152,000	\$24.0
Subtotal added initial cost		\$144,000	\$144,000	\$3.0
	Savings,	Savings,	PV	PV/ft <sup>2</sup>
Energy, maintenance, repair and replacement	\$/ft <sup>2</sup>			
HVAC incremental energy cost	-\$0.29	-\$13,920	\$ (272,838)	-\$5.68
Incremental annual maintenance	\$0.023	\$1,090	\$21,357	\$0.44
Incremental replacement and repair	N/A	N/A	\$25,922	\$0.54
Savings			NPV	NPV/ft <sup>2</sup>
Net present value savings			\$81,560	-\$1.70
			Annual	Annual
Annualized savings			Savings	Savings
Annualized equivalent savings, 30 year			\$4,161	\$0.087

VAV systems with chilled water and possibly hot water reheat would have additional plant-related maintenance, repair and replacement costs with a higher NPV than costs for VAV DX. Other zonal systems such as water-based fan coils, and WSHPs should have similar maintenance costs as VRF. Newer systems with equipment with no moving parts in the zone, such as chilled beams and radiant systems, may offer the lowest maintenance costs.

**NEW BUILDINGS**

The economic analysis presented above focuses on retrofits because the opportunity for energy savings both for individual projects and the overall building stock is significantly larger, the opportunity to reduce the incremental cost relative to other retrofit alternatives is greater because of the VRF limited space requirements, and finally, there could be maintenance and repair savings relative to old and failing existing systems. Table 8 shows that the energy cost savings relative to new buildings that are minimally compliant with 90.1-2010 are lower than for the current GSA average building. Because 90.1-2010 introduces new energy savings requirements that specifically reduce energy for VAV systems, energy savings will go down, and incremental cost will also go down. Reasonable paybacks for buildings that are intended for a long life, such as the public institutional buildings GSA would likely build, are still possible. Also, the life-cycle cost analysis suggests that even if an acceptable simple payback is achieved, careful attention should be paid to understanding the operating costs relative to other HVAC alternatives being considered.

The proper comparison for such building projects, particularly if they have sustainable design project requirements including energy efficiency, is sophisticated, energy efficient, newer types of HVAC systems, such as conventional systems optimized for efficiency, radiant systems, ground-source heat pump systems

and use of dedicated outside air systems with energy recovery. It is not possible to characterize all of the different cost scenarios. Projects of this type should undertake detailed energy analysis and life-cycle cost analysis of many alternatives appropriate to the project. VRF can be a competitive alternative in such a comparison.

## **B. APPROPRIATE APPLICATIONS**

VRF systems are most cost-effective when matched with applications and climates that offer the best value given the typically higher initial cost of the systems.

### *High Energy and Other Operating Costs*

- Energy usage higher than GSA's average of 60.7 kBtu/ft<sup>2</sup>
- Opportunity for conversion from VAV with electric reheat or buildings with other electric resistance heat
- Other energy cost savings measures already identified for the building
- Large maintenance and replacement costs from failing equipment, or other operating costs such as for water usage that could be reduced or avoided by switching to a new system.

### *Project Type*

- Retrofit projects, particularly where cooling capability needs to be added or increased, and/or where there is no or inadequate ductwork and space to add ductwork is constrained. Even if there is room for ductwork, installing refrigerant lines may be less expensive.
- Retrofits with existing ductwork may be suitable for adding a DOAS without needing to add ductwork. Utilizing existing equipment converted to a DOAS may result in control issues, as noted above.
- Buildings with fan systems working against unusually high static pressure.
- Historical buildings are particularly good candidates, if upgrading or replacing the existing systems with conventional systems would cause substantial disturbance in the building.
- Buildings that are owner occupied, where owner can institute major changes.

### *Building Type*

Buildings with small, separated areas can take full advantage of the zonal control capability of the fan units.

- Office buildings with a significant number of enclosed offices, conference rooms, and other separated spaces
- Schools
- Lodging
- Multi-family
- Healthcare

- Retail community shopping center and possibly small stores in malls. Owner would need to take advantage of the VRF automated option for tenant billing of electricity or find another way to allocate or pay the utility costs. This can add \$10,000 to \$20,000 per VRF compressor unit.

#### *Climate*

- Climates with more extreme weather will generate the most energy savings.
- Colder climates offer better opportunities for heat recovery, especially if there is a core with constant cooling requirements. The opportunity is enhanced if there are significant north and south exposures on the same building.
- Colder climates also result in large heating energy savings when converting to VRF from VAV with electric reheat or electric resistance primary or supplemental heat. This is also true to a lesser degree in converting to VRF from natural gas furnaces and boilers, or from central steam.

#### *Building Size*

- Projects under 5,000 ft<sup>2</sup> to 10,000 ft<sup>2</sup> may be less suitable because there are substantially less expensive alternatives. Above 80,000 ft<sup>2</sup> to 120,000 ft<sup>2</sup>, other alternatives may be more cost-effective. Some manufacturers are marketing heavily to expand the application of VRF to large projects that traditionally have had a chilled and hot water plant serving large VAV air handlers in the United States.

#### *Weaker candidates*

- Large open spaces such as big box retail, assembly halls, gymnasiums, and warehouses
- Systems in mild climates with a large number of economizer operating hours (ASHRAE climate zones 3 and 4)

### **C. MARKET POTENTIAL**

#### *GSA Buildings*

The potential for use of VRF technology in GSA's portfolio is tied to the actual energy savings performance, appropriateness of the technology to building types and climate, payback, the acceptability to the inhabitants, and the continued experience with the system in terms of equipment life, maintenance and reliability. Assuming these parameters are successfully addressed, the potential for application of VRF systems to GSA buildings could be proportional to the total size of GSA's building portfolio.

The potential portfolio impact is looked at over a 5-year period of new buildings and major renovation. Given changes in Standard 90.1-2010 and potential changes in the 2013 version of Standard 90.1, it is not possible to project initial costs and energy savings for projects more than 5 years in the future. An estimate of potential for GSA's buildings was made based on several assumptions:

- There are an estimated 12 total new building and major renovation projects annually under current practice based on anecdotal information from GSA. Assuming that four of these projects are suitable for VRF, over 5 years, provides a potential pool of 20 VRF projects.
- Average VRF project size is assumed to be 50,000 ft<sup>2</sup>, the size that matches what appears to be the core application relative to rooftop systems. Smaller and larger projects may be included.
- A pool of projects that can achieve a 10-year average simple payback can be identified. These would include buildings that are above average GSA building energy usage and energy cost and that have an incremental cost less than \$4.00/ft<sup>2</sup> relative to the alternatives.

The cost, energy savings, and payback for applying VRF technology to individual buildings, will vary greatly. A meaningful estimate of energy savings potential from application of VRF technology to GSA’s building portfolio as a whole can be made.

Table 16 summarizes the resulting building area of GSA’s portfolio affected, initial cost and energy cost savings potential.

**Table 16: Potential Impact of VRF Systems in GSA’s Existing and New Buildings**

Building area affected, cumulative for five years of projects	1 million ft <sup>2</sup>
Total initial cost at \$24/ft <sup>2</sup>	\$24 million
Incremental initial cost \$3.00/ft <sup>2</sup>	\$3 million
Annual energy cost savings potential at \$0.29/ft <sup>2</sup>	\$290,000/year
Simple payback	10 years

#### **D. BARRIERS AND ENABLERS**

While use of VRF technology is growing in the U.S. market, there remain significant barriers including (specifically for GSA) procurement issues, and more generally initial costs and limited availability of utility incentives, uncertainty about the energy savings, and the limited infrastructure of experienced designers and installers.

At the same time, there is momentum and support for expanding the role of VRF technology in the U.S. Efforts are underway that directly address the identified barriers. The market expansion is led by manufacturers with integrated approaches including training, quality control, leadership in development of standards, and support for development of VRF information resources and for research. Other enablers include the research underway to reduce the uncertainty about VRF system performance, and to support energy simulation to better estimate savings and the development of energy incentives for VRF systems from utilities and other organizations.

## Barriers

- Procurement
  - VRF systems are often designed with active involvement and even complete design from manufacturers with proprietary content and specific products selected. This will be difficult for GSA to reconcile with its approach to procurement, which begins with an independent design, followed by contractor bidding, with the selected bidder building the building, known as design/bid/build. Some designers and installers are developing the knowledge and experience to do the designs on their own. The components are not interchangeable though, so at some point, if a design becomes detailed enough, it will likely constrain the choices to a single manufacturer's products.
- Initial cost
  - Many owners and developers are interested in the lowest initial cost. The available information shows a significant initial cost premium for VRF relative to conventional HVAC systems. This is particularly true for new construction. For new construction, if not owner occupied, the developer has no interest in lowering operating costs. If a new or existing building project has a sustainability or energy cost focus from the beginning, then VRF should be evaluated along with other high performance building alternatives, and may be cost competitive with other options.
  - For renovations and retrofits, the incremental cost of options will vary. VRF systems may be the least expensive option to accomplish non-energy goals, such as adding cooling, or increasing cooling capacity with no or insufficient existing ductwork. VRF systems may be a good option for buildings with hydronic piping that needs to be replaced or repaired, as well as historical buildings where minimal changes are allowed.
  - Many utilities are not offering incentives for VRF systems, or are offering incentives based only on full load efficiency based on the initial cost premium and savings for conventional packaged or split system HVAC equipment.
- Uncertainty about the energy savings
  - One of the drivers for supporting adoption of new energy-efficient products is incentive programs from utilities, governments and others. Energy incentive programs require energy savings verification and evaluation.
  - Owners and developers who invest in higher-cost HVAC systems expect to earn a return on the investment in energy savings. If the return is in doubt, they will invest in other alternatives with a record of savings.
- Education and training - Suppliers, designers, installers, operators, maintenance staff and owners need to better understand VRF systems. Most manufacturers provide training, but independent resources are needed.

## Enablers

- Growing availability of energy incentives to offset initial cost
  - Utility incentives are beginning to be applied to VRF systems. Southern California Edison has had a supplier incentive for VRF systems since 2010. Efficiency Vermont and the Energy Trust of Oregon provide VRF system incentives equal to the incentive they provide for air-source heat

- pumps. Pacific Gas and Electric started a supplier incentive for VRF in April 2012. BPA is working on an incentive program and is starting a pilot project to test the use of simulation tools to verify energy savings.
- The manufacturers are pushing hard to expand the knowledge base and capability of designers and installers. This will likely increase competition and reduce the uncertainty about the technology and potentially reduce prices as bids can get tighter.
  - Research and certification
    - Research is underway to develop methods to verify savings, including modeling tools, and to resolve doubts about the field performance versus the AHRI-tested performance. As described above, EPRI and FSEC are engaged in lab testing, field testing and simulation software development, and BPA has begun a field test pilot on using energy simulation to verify savings. Development of this information will create more certainty about the savings, and encourage growth of incentive programs and investment in projects.
    - AHRI testing protocol for certification of VRF heat recovery operating efficiency is also in development; currently the performance in heat recovery mode is not certified.
  - Education and training
    - The manufacturers have an established and expanding training program for suppliers, designers, and installers apparent by searching their websites and the broader web for training opportunities.
    - The *2012 ASHRAE Handbook, HVAC Systems and Equipment* (ASHRAE 2012a) includes a chapter on VRF systems for the first time. Manufacturers were actively involved in the effort to add this, but it required broader support in ASHRAE to carry it forward.
    - At least one independent training outlet is providing VRF training
      - HVAC variable refrigerant flow (VRF) Systems at:  
<http://www.cedengineering.com/courseoutline.asp?cid=584>.



## VI. Summary Findings and Conclusions

### A. OVERALL TECHNOLOGY ASSESSMENT

VRF system technology has successfully demonstrated itself outside the U.S., where it dominates the HVAC market in many countries. The U.S. market has been slower to respond, but interest is growing. The systems offer energy saving, comfort control, flexibility, and ease of installation in existing buildings.

This study demonstrates, within the limit of the information available, that 30% or more is a reasonable estimate for HVAC energy cost savings for VRF as an alternative to existing systems, or new systems that are minimally code compliant, across a broad range of buildings, system types and climates. Added first costs varied from \$2/ft<sup>2</sup> to \$6/ft<sup>2</sup> for a range of conventional HVAC systems. The incremental costs appear relatively high, and opportunity for attractive simple payback is limited for the average or less than average GSA building energy usage. The findings suggest that GSA focus on existing and new buildings where the estimated incremental cost compared to package VAV and CAV systems is less than \$4/ft<sup>2</sup> and the annual energy usage is currently or modeled to be 60.7 kBtu/ft<sup>2</sup> with conventional HVAC systems. For larger buildings served by VAV systems with chilled water and hot water or electric reheat, VRF systems have potential for similar paybacks, but the data does not provide a clear distinction between air-cooled and water-cooled chillers, and air-cooled or water-cooled VRF systems.

VRF should be targeted at existing buildings with high energy bills, need for HVAC upgrades or cooling expansion with limited room for ductwork changes, climates with significant heating loads particularly where VRF can replace VAV systems with electric reheat or other electric heat, and projects between 5,000 ft<sup>2</sup> and 100,000 ft<sup>2</sup> buildings with multiple spaces that would benefit from independent temperature control. New buildings to target include projects with a green design objective and budget to support it, buildings that can take advantage of the potential to reduce floor to floor height, and the avoidance of more expensive controls and monitoring that may be included with VRF systems.

### B. BEST PRACTICES

The selection of appropriate building projects can be narrowed following the information gathered in this report. Use of pilot projects and commissioning are also recommended.

#### BEST PRACTICE: PROJECT SELECTION

##### *Energy Usage*

Buildings with higher energy usage than GSA's average usage of 60.7 kBtu/ft<sup>2</sup>.

##### *Building Type*

Buildings with smaller separated areas can take full advantage of the zonal control capability and the range of sizes of the fan coil units including office buildings, schools, lodging, multi-family, healthcare, strip malls, and small stores in malls.

### *Project Type*

Retrofit projects are a good focus, particularly where cooling capability needs to be added or increased, where there is no or inadequate ductwork, and space to add ductwork is constrained. Retrofits with existing ductwork may be suitable to add a DOAS without needing to add ductwork. Historical buildings are particularly good candidates if upgrading or replacing the existing systems with conventional systems would cause substantial disturbance in the building.

### *Climate*

Climates with more extreme weather will generate the most energy savings. Colder climates offer better opportunities for heat recovery, especially if there is a core with constant cooling requirements. The opportunity is enhanced if there are significant north and south exposures on the same building. Colder climates also result in large heating energy savings when converting to VRF systems from electric heat or reheat, and to a lesser degree from natural gas furnaces and boilers, or from central steam.

### *Building Size*

Projects under 5,000 ft<sup>2</sup> to 10,000 ft<sup>2</sup> may be less suitable because there are substantially less expensive alternatives than VRF. Above 80,000 ft<sup>2</sup> to 120,000 ft<sup>2</sup> other alternatives, such as VAV chilled water and hot water reheat systems with high efficiency plant equipment, and controls consistent with ASHRAE Standard 90.1-2010, may be more cost-effective. Chilled beam systems also with high-efficiency plant equipment, water-side economizer (in less humid climates) and energy recovery are another possibility worth considering.

### *Weaker Candidates*

Large open spaces, such as big box retail, assembly halls, gymnasiums, and warehouses, can be served much less expensively with single-zone systems. Mild climates with a large number of economizer operating hours (ASHRAE climate zones 3 and 4) offer low potential for fan and heating savings, and possibly increased cooling energy.

## **BEST PRACTICES: PILOT PROJECTS**

There is uncertainty about energy savings performance of VRF systems. GSA should consider a pilot project approach for several projects.

Picking at least two retrofit projects with different existing HVAC systems will allow a good comparison with many future potential projects. Gathering a baseline for comparison would include having at least 1 year's worth of energy utility data, and ideally monitoring that allows separating the HVAC energy usage from other energy usage categories. Establishing a baseline for occupant comfort through a poll would also be worthwhile.

### *New Building Pilots*

GSA should look for new building pilot projects with high energy-efficiency goals, and possibly other sustainable building goals and corresponding budgets. VRF may be cost competitive or offer a reasonable

simple payback and life-cycle cost compared to other high performance HVAC system alternatives particularly if VRF allows floor to floor heights and floor space for mechanical equipment to be reduced.

For both type of pilot projects, particularly for new building projects that don't have utility bills as a baseline, energy simulation building models should be developed for before and after, or new vs. code minimum.

Commissioning, particularly of zone temperature control, is recommended. There is limited evidence that the default fan coil unit control in some systems may result in cycling of the fan coil unit between heating and cooling and cause fluctuating space temperatures (Price 2009).

### C. BARRIERS TO ADOPTION

There are obstacles for moving aggressively into implementing VRF technology. Particularly for GSA, the procurement process may be a problem. Other issues are high initial cost, existing conditions, and uncertainty about the energy savings benefits.

#### *Procurement*

VRF systems are often designed with active involvement and even complete design from manufacturers. GSA will have difficulty reconciling this with design/bid/build approach it uses for procurement. In some markets, there may be designers and installers with the knowledge and experience to provide independent design. This is hampered by the significant differences in the products between the manufacturers, so that they are not interchangeable.

#### *Initial Cost*

Initial costs are relatively high compared to conventional alternatives. The selection approach for VRF projects in best practices above will help to limit the project mix to those with a lower incremental cost. For some renovations, like those needing increased heating or cooling capacity in buildings such as historical buildings constrained for space VRF systems may be less expensive than conventional systems. Additional ductwork may be needed for the conventional alternatives, while less or no ductwork is needed for the VRF option. Also, as knowledge and skills with VRF systems spread and competition increases in each market, prices may come down.

#### *Uncertainty about the energy savings*

Because there is a scarcity of thorough case studies and a heavy reliance on model estimates, questions remain about the magnitude of energy saving that can be realized. GSA can develop its own certainty about energy savings by implementing its first VRF projects as pilot projects to track the before and after energy usage. GSA can also follow the research underway, perhaps by joining the dialogue, or occasionally linking to the meeting notes and presentations at the Northwest Power and Conservation Council's (NWPC) Regional Technical Forum Variable Capacity Heat Pump Sub-Committee web page, <http://www.nwcouncil.org/energy/rtf/subcommittees/vchp/Default.htm>.

### *Education and training*

GSA can pursue training of its own staff involved with VRF. Resources from the manufacturer's and other sources are available online. The *2012 ASHRAE Handbook, HVAC Systems and Equipment* (ASHRAE 2012a) includes a chapter on VRF systems for the first time. GSA is also contributing with the Green Proving Ground technical evaluation of VRF systems.

#### **D. MARKET POTENTIAL WITHIN GSA PORTFOLIO**

The potential for use of VRF in GSA's portfolio will depend on early efforts, perhaps done as pilot projects. The determination of actual energy savings performance, payback, acceptability of the technology to the inhabitants, and the ongoing experience with the technology will shape how its application grows or not in the portfolio.

The potential portfolio impact is looked at over a 5-year period of new buildings and major renovation. Given changes in Standard 90.1-2010 and potential changes in the 2013 version of Standard 90.1, it is not possible to project initial costs and energy savings for projects more than 5 years in the future. An estimate of potential for GSA's buildings was made based on several assumptions:

- GSA completes roughly 12 total new building and major renovation projects annually under current practice based on anecdotal information from GSA. Assume that four of these projects are suitable for VRF. Over 5 years, this gives a potential pool of 20 VRF projects.
- Average VRF project size is assumed to be 50,000 ft<sup>2</sup>, the size that might otherwise use packaged rooftop units. Smaller and larger projects may be included.
- A pool of projects that can achieve a 10-year average simple payback can be identified. These would include buildings that are above average GSA building energy usage and energy cost and that have an incremental cost less than \$4.00/ft<sup>2</sup> relative to the alternatives.

The cost, energy savings, and payback for applying VRF technology to individual buildings, will vary greatly. A meaningful estimate of energy savings potential from application of VRF technology to GSA's building portfolio as a whole can be made.

This pool would add up to 1 million ft<sup>2</sup> of building area, at an initial cost of \$24 million, incremental cost of \$3 million, annual cost savings potential of \$290,000/year, and a 10-year simple payback.

#### **E. CONCLUSION**

GSA should implement VRF with targeted deployment in a subset of new buildings and major retrofits of existing buildings based on the potential cost-effectiveness. Projects should be evaluated carefully with energy modeling and cost assessment during design, and with actual operating energy and maintenance costs. Energy usage should be monitored so that HVAC energy can be separated from other energy uses. Occupant comfort should also be assessed.

Targeted VRF projects can provide a reasonable energy cost savings and simple payback. Higher maintenance, repair and replacement costs relative to some other system alternatives can offset much of the energy cost savings, and these costs should be evaluated when deciding whether or not to use VRF systems. VRF systems should be compared with other high efficiency HVAC alternatives during early design, and between operating buildings with different HVAC systems.

## VII. Appendices

### A. REFERENCES

AHRI (2012), "Directory of Certified Product Performance." Arlington, Virginia: AHRI. Accessed June 2012 at <http://www.ahridirectory.org/ahridirectory/pages/home.aspx>

Amarnath, A. and M. Blatt (2008), "Variable Refrigerant Flow Where, Why and How." *Engineered Systems*, February 2008.

ANSI/AHRI (2011), *ANSI/AHRI Standard 1230-2010 with Addendum I Performance Rating of Variable Refrigerant Flow (VRF) Multi-Split Air-Conditioning and Heat Pump Equipment*. Arlington, Virginia: AHRI.

ANSI/ASHRAE (2010), *ANSI/ASHRAE Standard 15 Safety Standard for Refrigeration Systems*. Atlanta, Georgia: ASHRAE.

ANSI/ASHRAE/IES (2010), *ANSI/ASHRAE/IES Standard 90.1-2010 Energy Standard for Buildings Except Low-Rise Residential Buildings*. Atlanta, Georgia: ASHRAE.

ANSI/ASHRAE/IESNA (2004), *ANSI/ASHRAE/IESNA Standard 90.1-2004 Energy Standard for Buildings Except Low-Rise Residential Buildings*. Atlanta, Georgia: ASHRAE.

ANSI/ASHRAE/IESNA (2007), *ANSI/ASHRAE/IESNA Standard 90.1-2007 Energy Standard for Buildings Except Low-Rise Residential Buildings*. Atlanta, Georgia: ASHRAE.

ASHRAE (2011), *2011 ASHRAE Handbook, HVAC Applications*. Atlanta, Georgia: ASHRAE.

ASHRAE (2012a), *2012 ASHRAE Handbook, HVAC Systems and Equipment*. Atlanta, Georgia: ASHRAE.

ASHRAE (2012b), "Dedicated Outdoor Air Systems: A Path to Balancing Energy and IEQ- an ASHRAE webcast." Presented April 19, 2012 online. Atlanta, Georgia: ASHRAE.

ASHRAE/AIA/IESNA (2011), *Advanced Energy Design Guide for Small and Medium Office Buildings*. Atlanta, Georgia: ASHRAE.

Aynur T. (2010), "Variable Refrigerant Flow Systems: A Review." *Energy and Buildings* 42 (2010) 1106-1112.

BPA (2012a), "Variable Refrigerant Flow HVAC Field Test." Portland, Oregon: Bonneville Power Administration.

BPA ( 2012b), “Jamestown S’Klallam Tribe Variable Refrigerant Flow System Case Study.” Portland, Oregon: Bonneville Power Administration.

BPA (2012c), “Lewis County PUD Variable Refrigerant Flow Case Study.” Portland Oregon: Bonneville Power Administration. Available at [http://www.bpa.gov/energy/n/emerging\\_technology/VRFFieldTest.cfm](http://www.bpa.gov/energy/n/emerging_technology/VRFFieldTest.cfm)

BPA (2012d), “Multi-family Housing Variable Refrigerant Flow Case Study.” Portland, Oregon: Bonneville Power Administration.

Butler, D., J. Gräslund, J. Hogeling, E.L. Kristiansen, M. Reinikainen, G. Svensson, ed. V. Maija (2004), Chilled Beam Application Guidebook. Federation of European Heating and Air-conditioning Associations (REHVA), Brussels, Belgium.

CBECs (2003), “Commercial Buildings Energy Consumption Survey.” Washington D.C. : Energy Information Administration, U.S. Department of Energy. Accessed June 2012 at <http://www.eia.doe.gov/emeu/cbecs/contents.html>

CEE (2012), *High Efficiency Commercial Air Conditioning and Heat Pump Initiative*. Boston, Massachusetts: Consortium of Energy Efficiency.

Demetrovic, R. and H. Upadhye. (2012). “Multi-Zone Testing of VRF Systems.” Presented February 22, 2012, Northwest Power and Conservation Council Regional Technical Forum Variable Capacity Heat Pump Working Group Meeting. EPRI. Available at [http://www.bpa.gov/energy/n/emerging\\_technology/pdf/BPA\\_VCHP\\_meeting.pdf](http://www.bpa.gov/energy/n/emerging_technology/pdf/BPA_VCHP_meeting.pdf)

Doppel P. (2012). “BPA Meeting.” Presented May 23, 2012, Northwest Power and Conservation Council Regional Technical Forum Variable Capacity Heat Pump Working Group Meeting. Available at <http://www.nwcouncil.org/energy/rtf/subcommittees/vchp/meetings.htm>

EES Consulting (2011), *Measure Summary Report: Variable Refrigerant Flow*. Portland, Oregon: Bonneville Power Administration.

EIA (2012). “Average Retail Price of Electricity to Ultimate Customers: By State by Sector, Latest Year” Washington D.C.: Energy Information Administration, U.S. Department of Energy. Accessed June 25, 2012 at <http://205.254.135.7/electricity/data.cfm>

Federal Real Property Council (2010), *The Federal Real Property Council’s FY 2010 Federal Real Property Report. An Overview of the U.S. Federal Government’s Real Property Assets*. Washington D.C.: U.S. General Services Administration.

FEMP (2012), "Technology Deployment List". Washington D.C.: U.S. DOE. Accessed June, 2012 at [http://www1.eere.energy.gov/femp/technologies/newtechnologies\\_matrix.html#cats](http://www1.eere.energy.gov/femp/technologies/newtechnologies_matrix.html#cats)

FSEC (2012), "Modeling Variable Refrigerant Flow (VRF) Heat Pump and Heat Recovery Equipment in EnergyPlus." Cocoa, Florida: FSEC. Presented June 17, 2012 at Northwest Power and Conservation Council Regional Technical Forum Variable Capacity Heat Pump Working Group Meeting.

Fuller, S.K. and S.R. Petersen (1995). *Life Cycle Costing Manual for the Federal Energy Management Program* (NIST Handbook 135). Washington D.C.: National Institute of Standards and Technology (NIST).

Goetzler, B. (2007). "Variable Refrigerant Flow Systems." *ASHRAE Journal*, April 2007.

GSA (2010), "GSA's Sustainability Plan Calls for 30 Percent Reduction of GHG Emissions" Washington D.C.: GSA. Accessed June 25, 2012 <http://www.gsa.gov/portal/content/183229>

GSA (2012), "HVAC." Washington D.C.: GSA Accessed June 21, 2012 <http://www.gsa.gov/portal/category/102515>

Hart, R and K. Campbell (2011), "VRF Application: Matching Technology with Load." Presented at CEE Industry Partners Forum October 6, 2011, Denver Colorado.

Heschong Mahone Group Inc., Portland Energy Conservation Inc., CTG Energetics, and Taylor Engineering (2010), "ECM Motors" presented to Nonresidential HVAC Stakeholder Meeting #2, California Statewide Utility Codes and Standards Program December 9, 2010.

Hong, T. and X. Liu (2010), "Comparison of Energy Efficiency Between Variable Refrigerant Flow Systems and Ground Source Heat Pump Systems" *Energy and Buildings*, 42, 584-589.

LG (2011), "Energy Efficiency Analysis for a Multi-Story Commercial Office Building." Seoul, Korea: LG.

LG (2012), "Variable Refrigerant Flow, Innovative Technology Can Cut Small-format Retailer's HVAC Energy Cost by 45%." Seoul, Korea: LG.

Mankins J. (1995), *Technology Readiness Levels, A White Paper*. Washington D.C.: NASA.

New Buildings Institute (2011) *A Search for Deep Energy Savings*. Vancouver, Washington: New Buildings Institute.



Price, W. (2009), "A Closer Look at Non-Commissioned VRF/VRV Mini-Split Systems." Presented December 2009 Building Simulation User's Group, Portland Oregon. Posted at <http://tech.groups.yahoo.com/group/BSUG/> - sign up required.

RS Means. 2012. *RMeans Mechanical Cost Data*, 35th Ed. Construction Publishers & Consultants. Norwell, Massachusetts.

RS Means. 2004. *Facilities Maintenance & Repair Cost Data*, 35th Ed. Construction Publishers & Consultants. Norwell, Massachusetts.

Rushing, A.S., J.D. Kneifel and B.C. Lippiat ), *Energy Price Indices and Discount Factors for Life-Cycle Cost Analysis – 2011*, Annual Supplement to NIST Handbook 135 and NBS Special Publication 709. Washington D.C.: U.S. Department of Commerce, National Institute of Standards and Technology.

Schnare, Rob (2011). "LEED Platinum Performance for Mercy Corps." *Engineered Systems*, February 2011.

Thornton, BA, MI Rosenberg, EE Richman, W Wang, Y Xie, J Zhang, H Cho, VV Mendon, RA Athalye (2011). *Achieving the 30% Goal: Energy and Cost Savings Analysis of ASHRAE Standard 90.1-2010*. PNNL-20405. Richland, Washington: PNNL.

U.S. Department of Energy, Office of Energy Efficiency and Renewable Energy (2012a), "Securing America's Future with Energy Efficient Buildings." Washington D.C.: USDOE. Last accessed June 21, 2012 at [www1.eere.energy.gov/buildings/about.html](http://www1.eere.energy.gov/buildings/about.html)

## B. LIST OF ABBREVIATIONS AND ACRONYMS

AC	air conditioning
AC	alternating current
AHRI	Air Conditioning Heating and Refrigeration Institute
AHU	air-handling unit, fan system with chilled water coils and variety of possible heat sources
AIA	American Institute of Architects
ANSI	American National Standards Institute
ASHRAE	American Society of Heating Refrigerating and Air-conditioning Engineers
BPA	Bonneville Power Administration
CAV	constant-air volume – type of HVAC fan control
CEE	Consortium for Energy Efficiency
CBECs	Commercial Buildings Energy Consumption Survey
COP	coefficient of performance, measure of HVAC direct expansion system efficiency, typically for heat pump heating efficiency
DC	direct current
DOAS	dedicated outside air unit
DOD	U.S. Department of Defense
DOE or USDOE	U.S. Department of Energy
DRL	deployment ready level
DX	direct expansion, type of HVAC air-conditioning equipment in which the evaporator is in direct contact with the air stream
ECM	electronically commutated motor
EIA	United States Energy Information Agency
EER	energy-efficiency ratio, a measure of the full load efficiency, typically for unitary DX HVAC equipment
E.O.	Executive Order, United States executive office directive
EPRI	Electric Power Research Institute
ESA	European Space Agency
EU	European Union
EUI	energy usage index
FEMP	Federal Energy Management Program
FSEC	Florida Solar Energy Center
GPG	Green Proving Ground, United States General Services Administration energy efficiency technology assessment initiative
GSA	United State General Services Administration
hp	horsepower
HVAC	heating ventilation and air conditioning
IDU	indoor unit
IEER	integrated energy efficiency ratio, measure of unitary DX HVAC equipment energy performance under a weighted average range of loading conditions

IES	Illumination Engineering Society
IESNA	Illumination Engineering Society of North America
IPLV	integrated part load value rating of chiller equipment energy performance under a weighted average range of loading conditions
ISO	International Standards Organization
LCCA	life-cycle cost analysis
M&V	measurement and verification, means of evaluating actual energy performance and other elements of building operations
NASA	National Aeronautics and Space Administration
NPV	net present value
NWPCC	Northwest Power and Conservation Council
ODU	outdoor unit
OH&P	overhead and profit
PNNL	Pacific Northwest National Laboratory
PV	present value
RTU	roof-top unit, HVAC packaged unitary DX unit
SCE	Southern California Edison
TRL	technology readiness level
VAV	variable-air volume, type of HVAC fan control
VFD	variable-frequency drive
VRF	variable refrigerant flow
VRV	variable refrigerant volume
w.g.	water gauge
WSHP	water-source heat pump

## C. GLOSSARY

The following is a glossary of advanced terminology in support of this report.

Terminology	Description
Air-cooled chiller	A refrigerating machine in which heat removal is accomplished entirely by heat absorption by air flowing over condensing heat exchanger surfaces (condenser is air cooled).
Air-handling unit (AHU)	A device used to condition and circulate air as part of a heating, ventilating, and air conditioning (HVAC) system
Alternating current (AC)	Electric current in which the flow of electric charge periodically reverses direction
BACNet	A communications protocol for building automation and control networks. It is an ASHRAE, ANSI, and International Standards Organization standard protocol.
Baseline	Typically referring to an energy profile, model and/or characteristics before changes have been made to a system for the purpose of modeling the original operating condition, derived from measurements are taken over a period of time and used as a basis for comparison to one of more options or alternatives.
Boiler (hot water)	A closed pressure vessel that consumes energy for the purpose of heating water or other fluids.
Building automation system (BAS)	A computerized network of electronic devices designed to monitor and control the mechanical, electronics, and lighting systems in a building.
Capacity	Intended technical full-load (a.k.a., maximum) sustained output of a facility, system, or device. Typically quantified as a power rating or rate of energy transfer. May also be known as nameplate capacity, rated capacity, nominal capacity, or installed capacity.
Chilled beam	An HVAC system that uses air movement over water coils in a device in the space to be conditioned. Chilled water and possibly hot water are provided. The chilled beam can be “active” with air from a central source, or “passive” with air flow movement through buoyancy and convection due to the temperature differential from the water coil. The air flow is a mix of the forced or passive air flow, and induced air recirculated from the space.
Chilled-water pumps	Pump and motor system used to circulate chilled water for space or process cooling distribution systems.

Terminology	Description
Chiller	A machine that removes heat from a liquid via a vapor-compression or absorption refrigeration cycle.
Climate zone	A region with similar weather characteristics.
Coefficient of performance (COP)	The ratio of the heating or cooling provided divided by the electrical energy consumed, as a unit-less measure. The COP provides a metric of performance for heat pumps that is analogous to thermal efficiency for power cycles.
Commission (commissioning process)	A quality-focused process for enhancing the delivery of a project. The process focuses upon verifying and documenting that the facility and all of its systems and assemblies are planned, designed, installed, tested, operated, and maintained to meet the Owner's Project Requirements.
Condenser	The part of a refrigerant system where refrigerant is liquefied by removal of heat through use of a heat sink.
Condenser-water temperature	The temperature of the water departing the cooling tower and/or entering the water-cooled condenser.
Condenser-water temperature reset	An operating strategy in which the condenser-water temperature set point is varied in response to a control signal or varying sensor input.
Condensing boiler	A boiler designed to extract sufficient heat energy that, under the right set of operating conditions, the moisture resulting from the products of combustion may condense from vapor to liquid allowing the heat energy released to be absorbed and recovered by the heat transfer fluid.
Condensing coil	A heat exchanger in which the refrigerant rejects heat to the point where the refrigerant condenses from vapor to liquid.
Condenser-water pump	Motor-driven pump used to circulate water through the condensing system
Constant speed	A motor system in which the motor's rotational speed remains (relatively) constant--may be applied to a pump, fan or chiller.
Constant-air volume (CAV)	A type of HVAC system that delivers supply air at a constant flow rate but in which the supply temperature will vary to meet variable thermal loads.
Cooling load	The heat energy needed to be removed from a space to maintain the desired space temperature set point.

Terminology	Description
Cooling tower	A heat removal device used to transfer (reject) heat to the atmosphere via the evaporation (mass transfer) of water.
Dedicated outdoor air system (DOAS)	A type of HVAC system that consists of two parallel systems: a dedicated outdoor air ventilation system that handles latent loads and a parallel system to handle sensible loads.
Dehumidification	The act of removing moisture (from air).
Dehumidify	The removal of moisture (from air).
Design conditions	Specified environmental conditions, such as temperature and humidity, required to be produced and maintained by a system.
Direct current	Electric current that with charge that flows in one direction
Direct expansion (DX)	Evaporator arrangement whereby liquid refrigerant is fed through an expansion device and evaporates completely before leaving as vapor.
Economizer (HVAC)	A duct and damper arrangement and automatic control system that together allow a cooling system to supply outdoor air to reduce or eliminate the need for mechanical cooling during mild or cold weather.
Dry-bulb temperature	The air temperature normally measured by a standard air thermometer.
Efficiency	Typically energy output divided by energy input, but may also be defined as useful energy output divided by consumed energy input.
Electronically commutated motor (ECM)	Also known as brushless direct-current (DC) motors are synchronous motors powered by a DC electric source via an integrated inverter/switching power supply, which produces an AC electric signal to drive the motor. ECM motors are much more efficient than other fractional horsepower motor types.
Energy-efficiency ratio (EER)	A ratio of the net refrigerating capacity in Btu/h to the power input value in Watts at a given set of rating conditions, expressed in Btu/(h · W).
Energy-use intensity (EUI)	A metric determined as energy consumed within an facility divided by the gross square foot of the facility, expressed as Btu/ft <sup>2</sup> -yr.
Enthalpy wheel	A heat recovery device used to exchange both sensible and latest heat energy between two (air) streams.

Terminology	Description
Fan coil unit	A small air-handling unit consisting of a heating and/or cooling coil and a fan used to serve a single space (control zone) without a ducted air distribution system. The coils are typically designed for use with heated or chilled water and used to condition air recirculated within the space.
Full load	The nominal peak load that a piece of equipment is designed to carry under design conditions.
Ground-source	Refers to use of the ground as a heat source or sink. Can refer to the wells or well fields that are used to access the ground and act as a heat exchanger. See also ground-source heat pump.
Ground-source heat pump	A heat pump using a brine solution circulating through a subsurface piping loop that functions as a heat source/heat sink.
Heat pump	A thermodynamic heating/refrigerating system used to transfer heat. The condenser and evaporator may change roles to transfer heat in either direction.
Heat-transfer fluid	A fluid, such as water or water-glycol solution) used to transfer heat from the heat source (equipment) to the heat sink (load).
Humidity ratio	A measure of the absolute humidity in moist air, expressed as the mass of water contained per mass unit of dry air.
Integrated energy-efficiency ratio (IEER)	A partial-load efficiency measure, calculated with the sum of weighting factors applied to tested efficiencies at four part-load conditions: (EER at 25%) X 0.125 + (EER at 50%) X 0.238 + (EER at 75%) X 0.617 + EER at 100%) X 0.02.
Integrated part-load value (IPLV)	A single-number metric based on part-load EER, COP, or kW/ton expressing part-load efficiency for air conditioning and heat pump equipment on the basis of weighted operation at specific increments of load capacities for the equipment. Typically used for ARI rating purposes
Kilowatt	An electric power term, meaning a rate of electric energy consumption.
Kilowatt-hour	An electric energy term, equal to 3412 Btu and 1,000 watt-hours.
latent heat	Heat exchanged by a thermodynamic body based on a phase change, such as water condensing into liquid or liquid evaporating into vapor.
Life-cycle cost	The total discounted dollar costs of owning, operating, maintaining, and disposing of a building or building system over the study period.

Terminology	Description
LONworks	Short for local operation network, it is a networking platform created to address the needs of control applications. The platform is built on a protocol created by Echelon Corporation for networking devices over media such as twisted pair, power lines, fiber optics, and radio frequency. The protocol is also one of several data link/physical layers of the BACnet ASHRAE/ANSI standard for building automation.
Modular configuration	An assembly consisting of multiple smaller units to provide a larger system capacity.
Net-present value	The difference in life-cycle cost analysis of two project alternatives.
Nominal (capacity)	The capacity reported by the manufacturer for a specified device under general conditions or recorded and reported by a given test.
Occupied (period)	A period in which a facility is typically occupied as a result of the normal business process.
Power	The rate at which energy is transferred, used, or transformed; also the rate at which this work is performed. Power is determined as energy divided by time.
Rate tariff	The schedule of charges and fees charged by a provider of energy services, such as a utility.
Roof-top unit (RTU)	A packaged HVAC system designed to be mounted on the roof.
Sensible heat	Heat exchanged by a thermodynamic system based solely on a change in temperature.
Sensor	A device that measures a physical quantity and converts it into a signal that can be read by an observer or electronic instrument or system.
Service life	The expected usable or economic life (years) expected from a piece of equipment or system. The period of time over which a system continues to generate benefits.
Simple payback	The time in which an investment is recovered, or repaid, through the accumulation of savings, determined as installed cost divided by savings; however, the result must be less than or equal to the service life of the project.
Split system	A packaged HVAC system consisting of two primary components; and indoor system for delivering heating, cooling and ventilation to the control zone; and an outdoor system for heat rejection.



Terminology	Description
Static pressure	The pressure at a specific point as can be measured using a pressure sensor. (To avoid potential ambiguity when referring to pressure in fluid dynamics, many authors use the term static pressure to distinguish it from total pressure and dynamic pressure. Static pressure is identical to pressure.)
Therm	A quantity of thermal energy equal to 100,000 Btu.
Ton (cooling)	A unit of measure equal to 12,000 Btu/h, the equivalent energy absorbed by melting 1-ton of ice from solid to liquid at 32°F in a 24-hour period.
Typical meteorological year (TMY)	A typical meteorological year (TMY) is a collation of selected weather data for a specific location, generated from a data bank much longer than 1 year in duration. It is specially selected so that it presents the range of weather phenomena for the location in question, while still giving annual averages that are consistent with the long-term averages for the location in question.
Unoccupied (period)	A period outside of normal business-occupancy time. Although the facility may still have occupancy, the occupancy level is significantly below what is considered normal during the business process.
Useful life	The expected usable or economic life (years) expected from a piece of equipment or system. The period of time over which a system continues to generate benefits.
Utility	An energy-service provider.
Utility program	An incentive or support program sponsored by a serving utility company.
Variable speed	A system in which the (rotational) speed can vary as a result of changing control parameters.
Variable-air volume (VAV)	A type of HVAC system in which the supply air flow rate to the conditioned space varies to meet variable thermal loads.
Variable-frequency drive (VFD)	A type of adjustable-speed drive used in electro-mechanical drive systems to control AC motor speed and torque by varying motor input frequency and voltage.
Water-cooled chiller	A chiller in which water is used in the refrigerant condensing process.
Water-side economizer (HVAC)	A heat exchanger that uses the condenser water side of the system for cooling without requiring the operation of the chiller when conditions are favorable.
Water-source heat pump	A heat pump using a pre-conditioned water source (e.g., cooling tower or boiler) as a heat source/heat sink.

Terminology	Description
Wet-bulb temperature	Temperature measurement that includes the moisture content of the air and is very close to the dew-point temperature, the temperature that water vapor will condense from the air that the wet-bulb temperature is being measured in.
Zone (thermal control zone, HVAC)	A space (or group of spaces) within a building with heating or cooling requirements that are sufficiently similar so that desired conditions can be maintained throughout using a single controlling device.

