



Prepared for the US General Services Administration

By Dan Howett, PE

Oak Ridge National Laboratory

Revised August 2017

Variable-Speed Screw Chiller Sidney Yates Building Washington, DC

Dan Howett, PE

Mark Adams

George Ostrouchov, PhD



The Green Proving Ground program leverages GSA's real estate portfolio to evaluate innovative sustainable building technologies and practices. Findings are used to support the development of GSA performance specifications and inform decision-making within GSA, other federal agencies, and the real estate industry. The program aims to drive innovation in environmental performance in federal buildings and help lead market transformation through deployment of new technologies.

Disclaimer

This document was prepared as an account of work sponsored by the United States Government. While this document is believed to contain correct information, neither the United States Government nor any agency thereof, nor Oak Ridge National Laboratory (UT-Battelle, LLC), nor any of their employees, makes any warranty, express or implied, or assumes any legal responsibility for the accuracy, completeness, or usefulness of any information, apparatus, product, or process disclosed, or represents that its use would not infringe privately owned rights. Reference herein to any specific commercial product, process, or service by its trade name, trademark, manufacturer, or otherwise, does not constitute or imply its endorsement, recommendation, or favoring by the United States Government or any agency thereof, or Oak Ridge National Laboratory (UT-Battelle, LLC). The views and opinions of authors expressed herein do not necessarily state or reflect those of the United States Government or any agency thereof or Oak Ridge National Laboratory (UT-Battelle, LLC).

The work described in this report was funded by the US General Services Administration under Contract 2375-V544-12

Acknowledgments

Sidney Yates Building: Samantha Dennison and Kenny Thompson, Building Managers

Sidney Yates Building: Glenn Stewart and Randy Burgess, Contractor Operations Staff

United States General Services Administration (GSA): Mike Lowell, GPG Project Manager

United States General Services Administration (GSA): Jason Smith, NCR Project Manager

Oak Ridge National Laboratory: Jenni Craddick, Financial Analyst

Tenfold Information Design Services: Andréa Silvestri and Bill Freais

For more information contact:

Kevin Powell

Program Manager

Emerging Technologies

Office of Facilities Management, Public Buildings Service

US General Services Administration

50 United Nations Plaza

San Francisco, CA 94102-4912

Email: kevin.powell@gsa.gov

Table of Contents

Disclaimer	i
Acknowledgments	i
List of Figures.....	iv
List of Tables	v
Preface.....	vi
I. Executive Summary	1
II. Introduction.....	3
A. Objectives.....	3
B. Opportunity.....	4
C. Technology Description.....	4
III. Methodology	5
A. Demonstration Objectives	5
B. Criteria for Site Selection	6
IV. Measurement & Verification Plan	6
A. Description of Demonstration Site.....	6
B. Test Plan	7
C. Instrumentation Plan	8
V. Measurement & Verification Results	9
A. Energy Consumption Rates vs. Percent Full Load	9
B. Energy Consumption Rates vs. Condenser Water Return Temperature	12
C. Operating with High and Low Condenser Water Temperatures	16
D. Energy Savings.....	17
E. Cost-Effectiveness Analysis	17
F. Occupant Satisfaction	18
G. Installation and Commissioning	18
H. Operations & Maintenance.....	18
I. Information Technology Security	19
VI. Summary Findings and Conclusions	19
A. Overall Technology Assessment at Demonstration Facility	19
B. Lessons Learned and Recommendations	19
C. Barriers and Facilitators to Adoption	21
D. Deployment Recommendations	21
VII. Appendices	21
A. Detailed Technology Specification	21
B. Instrument Cut Sheets	27

C. Correspondence Regarding the Correct Sizing of the MBC Chiller	37
D. References.....	45

List of Figures

<i>Figure</i>	<i>Page</i>
Figure P-1. Chillers' instantaneous energy consumption points (20% to 100% full load).....	xii
Figure P-2. 95% confidence interval around polynomial curve fit.	xiii
Figure P-3. LOESS analysis with 95% confidence interval.	xiv
Figure P-4. Energy consumed (in kilowatt-hours) per hour when condenser EWT is between 67.5°F and 72.5°F.	xvi
Figure P-5. Energy consumed (in kilowatt-hours) per hour when condenser EWT is between 72.5°F and 77.5°F.	xvii
Figure P-6. Energy consumed (in kilowatt-hours) per hour when condenser EWT is between 77.5°F and 82.5°F.	xvii
Figure 1. Sample tables showing how data on chiller performance were gathered and recorded.....	8
Figure 2. Schematic diagram showing the relative positions of the various instruments used to track performance parameters.	9
Figure 3. Chillers' instantaneous energy consumption points (20% to 100% full load).....	10
Figure 4. Yates Building operating load profile.	11
Figure 5. Average energy consumption rate for each chiller.	11
Figure 6. Energy consumption rate vs. condenser water return temperature when the chillers are running at 20%–100% of full load.....	12
Figure 7. Energy consumption rate plotted against condenser water return temperature when the chillers are operating at 0 to 20% of full load.....	13
Figure 8. Energy consumption rate plotted against condenser water return temperature when the chillers are operating at 20% to 40% of full load.....	14
Figure 9. Energy consumption rate plotted against condenser water return temperature when the chillers are operating at 40% to 60% of full load.....	15
Figure 10. Energy consumption rate plotted against condenser water return temperature when the chillers are operating at 60% to 80% of full load.....	15
Figure 11. Energy consumption rate plotted against condenser water return temperature when the chillers are operating at 80% to 100% of full load.....	16

List of Tables

<i>Table</i>	<i>Page</i>
Table P-1. Instrumentation Plan.....	x
Table P-2. Relative operating time that the MBC (aka “centrifugal”) spent operating within each paired conditions of “Chiller Load” and “Condenser EWT” as compared to time spent by the VSS chiller.....	xi
Table ES.1. Performance Objectives.....	2
Table 1. Parameters Closely Tracked during the Evaluation	8
Table 2. Energy Savings and Greenhouse (GHG) Emissions Reduction.....	17
Table 3. Economic Assessment.....	18

Preface

Introduction

In December 2016, the General Services Administration (GSA) published a GSA Proving Ground (GPG) study, GPG-031, *Variable-Speed Direct Drive Screw Chiller Final Report, Sidney R. Yates Building*. This study evaluated the performance of a Carrier Corporation chiller that uses a variable speed screw (VSS) compressor under field conditions at the Sidney R. Yates Building (Yates) in Washington, DC. Its performance was compared to that of a Daikin chiller that uses a magnetic bearing compressor (MBC) which was collocated at the site and installed in parallel to the VSS chiller. Danfoss Turbocor Compressors (Danfoss) manufactured the compressor used on the MCB chiller.

In February 2017, GSA received written comments from Danfoss and Daikin. GSA commissioned a third-party review of the report in light of the concerns raised by Danfoss and Daikin. This review was performed by the National Renewable Energy Laboratory and included assessing the suitability of the measurement and verification (M&V) plan, field instrumentation, and data analysis employed in conducting the GPG-031 to deliver accurate results. GSA's paramount concern was to ensure that GPG test bed evaluation outcomes are accurate, objective and credible.

This revised document reflects the outcome of that review. It is divided into three parts. The "Preface" and its subsections provide additional detail on the test bed design and field data collection, as well as additional data analysis. The body of the original report, which begins on Page 1, has been edited for clarification and to remove language which had been misinterpreted. The appendices from the original report have been expanded to include relevant information that complements the Preface and edits to the original report's body.

In its entirety, this report clarifies valid conclusions that can be drawn from the analysis of data collected as part of the study and the subsequent review.

Background

Ten percent of a typical commercial office building's energy goes to space cooling. For the 32%¹ of commercial buildings relying on a central plant to provide this cooling, selecting a chiller will have a large and lasting impact on a facility's energy and operating costs.

A previous GPG study, GPG-009 "Variable-Speed Oil-Free Centrifugal Chiller with Magnetic Bearings" (December 2013), evaluated a chiller using the MBC technology at a test bed location in Pine Bluff, Arkansas. This study found that, compared to a Federal Energy Management Program– (FEMP)-designated² high efficiency rotary screw chiller, the MBC chiller delivered a 35% improvement in efficiency with greatly reduced noise. GSA has subsequently recommended targeted deployment of MBC technology.

In 2014, a new high efficiency VSS chiller was submitted in response to GPG's RFI for consideration by the program. This submission claimed that their technology "already has the best published efficiency in the industry (as low as 0.299 kW/Ton IPLV)"³ and would likely deliver improved performance at comparable or lower

¹ GPG study, GPG-009 "Variable-Speed Oil-Free Centrifugal Chiller with Magnetic Bearings" (December, 2013); available at the following link: <https://www.gsa.gov/portal/content/180775>.

² <https://energy.gov/eere/femp/purchasing-energy-efficient-water-cooled-electric-chillers>.

³ Carrier's submission to the GPG program.

cost and across a greater band of operating conditions “as design conditions change.”⁴ Based on this information, GSA selected the technology for inclusion in the program and further evaluation.

Test Bed Selection

GSA’s goal is to provide the best possible value to the taxpayer by making sound investment decisions in advanced building technologies. These decisions are made based on how each technology performs in actual operating facilities, as opposed to performance measured in a controlled environment such as a laboratory or test facility. To meet this requirement, the GPG uses GSA’s portfolio of federally-owned properties to find a location in which to conduct each technology’s evaluation.

Oak Ridge National Laboratory (ORNL) developed a set of technical attributes that described a building which would make a valid test location to measure the VSS chiller’s performance. Based on these characteristics, GSA facility management staff identified the Sidney R. Yates Building (Yates Building) in Washington, D.C as satisfying all of the selection criteria. The Yates Building, a 208,000 ft² brick office building, was constructed in 1880 and was completely renovated as modern office space in 2013. When the renovation was completed, cooling for the building continued to be provided by two 350-ton chillers. A chiller replacement project, “right sizing” the cooling capacity to current loads, was planned to complete this project.

As the chiller retrofit project was initially designed, two MBC chillers were specified. These units were to be of the same technology type that proved its performance in the previously mentioned GPG evaluation. However, by installing one VSS chiller in place of one MBC unit, the new technology’s performance could be evaluated and compared to the baseline performance of the current state-of-the-art chiller technology. Each chiller’s performance could be measured concurrently, thereby minimizing any impact that weather or occupancy changes would have over an extended time period.

Test Bed Design

GSA asked Setty & Associates (Setty), an engineering firm previously been retained for the Yates Building chiller replacement project, to revise their design for an optimized chilled water plant at the Yates Building to substitute a VSS chiller for one of the MBC units. The chillers were to be of equal cooling capacity, one using MBC and one using VSS technology. Setty’s system design was such that the chillers worked in parallel, serving the same chilled water loop in the building, the same cooling tower/condenser water loop, and the same pumps that served both water loops. The design was to create an operating environment for each chiller that was as equal as possible in an actual building.

The specified cooling capacity for each chiller was 275 tons, the capacity determined as sufficient for each individual chiller to carry the whole building load in all but the most extreme of operating conditions. The design was intended to support a test plan in which the chillers would alternate days of operation while meeting the comfort needs of the Yates Building’s occupants.

The traditional federal procurement process was followed for purchasing the MBC technology. The VSS technology was obtained through GPG’s RFI and donation acceptance process. Appendix A of the report shows the cut sheets for the installed MBC and VSS chillers.

⁴ Carrier’s submission to the GPG program.

MBC Chiller Cooling Capacity

Subsequent to initial publication of the report, the evaluation team was informed by Danfoss, the MBC compressor original equipment manufacturer (OEM), that the installed MBC chiller was not, in fact, the most efficient MBC chiller available at the time. They asserted that it was, in fact, oversized for the requested capacity of 275 tons refrigeration.

To understand how this claimed disparity occurred, the project team conducted a thorough review of events that led to the selection and installation of the MBC chiller deployed at the Yates test bed. This review included examination of all correspondence between the project engineers, the project manager, the vendor, and the evaluation team. The review also includes on-site inspection of individual components of the MBC chiller. Details of the review are given in Appendix C of this report.

After thoroughly reviewing all documents and correspondence on this issue, the evaluation team draws the following four conclusions.

- The MBC chiller provided by the vendor in response to GSA’s request for a high-performance 275-ton unit can, in fact, provide up to 400 tons of cooling.
- At no time throughout the entire process, up until spring 2017, did the project team have any reason to believe that they had received anything other than an optimized 275-ton Daikin chiller from Havtech. Due diligence was performed at every step to verify that an appropriate 275-ton MBC chiller was installed at the Yates test bed. The installed MBC chiller is therefore representative of a vendor-supplied chiller meeting engineering requirements for a 275-ton load delivered through a well-managed federal procurement process.
- The test bed design for GPG-031 was to use a chiller technology that GPG had previously proved out as delivering known state-of-the-art-performance (MBC) as a baseline to compare a second chiller technology (VSS) with similar or better performance claims. The MBC vendor confirmed that they believed they were providing the most efficient MBC chiller for the project at the Yates test bed. All documentation supports the installed MBC chiller as legitimately representative of what a typical engineering and procurement process would deliver for this application and, therefore, a credible baseline.
- Retrospective speculation about what a different MBC chiller’s performance “could have been” is outside the scope of this assessment. It cannot be known whether the performance of a chiller of lower nominal tonnage would have had an incrementally positive, incrementally negative or negligible impact on aggregate chiller performance.

Measurement and Verification (M&V) Design

The prime M&V objective of this study was to measure the energy consumption rate for each chiller under similar conditions. The energy consumption rate is a metric that shows the amount of electrical power, measured in kilowatts, required at any moment to produce the corresponding quantity of cooling, measured in tons refrigeration. Therefore, the units for energy consumption rate are kilowatts per ton, shown in shorthand as “kw/ton.”

In their letter of February 2017, Daikin and Danfoss both pointed to a perceived lack of detail and documentation in the original report. They focused on the relative accuracy and level of uncertainty in the methods used to collect and analyze data and compared this to methods used in GPG-031, as originally published by GSA.

In response to these comments, the evaluation team performed additional peer review of the test bed M&V design, including the instrumentation’s accuracy, and the appropriateness of field measurement methods. Also, the project team analyzed the data beyond that in the original report, including two forms of statistical confidence analysis. The team also applied a simplified M&V method used by some energy service companies to compare chillers’ performance. This information is summarized below.

Approach to Field Measurement of Power and Cooling

Power was measured by a revenue grade meter installed on the electrical service to each chiller.

The “tons of refrigeration” part of the metric was calculated by measuring the water flow through each chiller (gallons per minute) plus the entering and leaving water temperatures (degrees Fahrenheit). The values were inserted into the following equation to calculate tons refrigeration.

$$Tons\ Refrigeration = [Flow\ (gpm) \times (T_{in} - T_{out})(^{\circ}F)] \div 24.0$$

The equation above is a simplification of those below, which show the details of water’s density and specific heat, as well as the conversions necessary to reach units of “tons refrigeration.”

$$Q = [V \times \rho \times C_p \times (T_{in} - T_{out})] \times (1cf/7.48\ gallons) \times (1\ ton\ refrigeration/12,000btuh) \times (60\ minutes/hour)$$

$$V = Flow\ Rate\ (gallons\ per\ minute)$$

$$\rho = Water\ Density\ (62.4\ lb/cf\ between\ 40^{\circ}F\ \&\ 60^{\circ}F)$$

$$C_p = Water\ Specific\ Heat\ (1\ btu/(lbm * ^{\circ}F))$$

The preferred plan for measuring flow rate across the evaporator and condenser of each chiller would have been to install a flow meter on the common chilled water and condenser water headers, as well as on the individual chiller’s piping so measurements could be continued if both chillers were required to operate simultaneously. However, space constraints did not allow appropriate straight pipe runs for these meters to operate properly. Therefore, flow rates were estimated at each chiller by measuring the pressure drop across each heat exchanger (psi) and correlating it to flow/pressure drop data provided by each manufacturer using the following equation.

$$Flow\ (gpm) = C_v \times \sqrt{Pressure\ Drop\ (psi)}$$

The flow coefficient, C_v, for each chiller’s evaporator section was calculated directly from flow and pressure drop data provided in each manufacturer’s chiller cut sheets.

MBC Chiller: 471.43 gpm at 5.6 ft w.c. (2.42 psi) yields a C_v of 303
 VSS Chiller: 470.9 gpm at 8.6 ft w.c. (3.72 psi) yields a C_v of 244

Data in the VSS cut sheet acknowledge that the pressure drop varies slightly with changes in fluid temperature, while the MBC data show the pressure drop as constant. Calculating the high and low values for the VSS chiller's C_v shows a variation of less than +/-1% from its mean value. A +/-1% variation was applied to both chillers' C_v values when calculating overall variation of their energy consumption rates.⁵

Each chiller's operating profile, measured condenser water temperature, and percent full load were tracked using the instrumentation described in Table P-1.

Table P-1. Instrumentation Plan

Parameter	Instrument	Units/Accuracy
Site chilled water return temperature (aka "Evaporator Entering Water Temperature")	Johnson Controls TE-6300 Nickel	Degrees Fahrenheit, +/-0.34°F
Site chilled water supply temperature (aka "Evaporator Exiting Water Temperature")	Johnson Controls TE-6300 Nickel	Degrees Fahrenheit, +/-0.34°F
Site condenser water supply temperature	Johnson Controls TE-6300 Nickel	Degrees Fahrenheit, +/-0.34°F
Site condenser water return temperature	Johnson Controls TE-6300 Nickel	Degrees Fahrenheit, +/-0.34°F
MBC and VSS evaporator flow rate	Setra Model 230 differential pressure (dP) sensor. dP was combined with the respective chiller's flow coefficient (C_v) to determine flow in gallons per minute.	Differential Pressure - PSI, +/-0.25% Flow Coefficient - GPM/PSI ^{0.5} , +/-1% Evaporator Flow Rate - GPM, +/-3%
MBC and VSS power consumption rate	Veris E5X	Kilowatts, +/-0.2%

Cut sheets for the power meter, temperature sensor, and differential pressure sensor are shown in Appendix B of the report.

Performance Measurement and Instrumentation Uncertainty

Data gathered during this study show that the VSS chiller had, on average, an energy consumption rate of 0.623kw/ton and the MBC chiller had an average energy consumption rate of 0.699kw/ton. Put another way, the VSS chiller consumed approximately 11% less electricity per ton than the MBC chiller.

⁵ ORNL is confident that the method of estimating flow through each chiller (calculating C_v from manufacturer's literature, measuring pressure drop and using those values to estimate flow) is the most accurate possible approach to comprehensive measurement of chiller performance under the site specific field conditions at the Yates test bed. During the third-party review, NREL validated this approach as innovative, but not broadly accepted.

To corroborate its accuracy, the evaluation team analyzed the data set a second way, comparing the hourly energy consumed by each chiller and correlating it to the average hourly outside air temperature. In this way, the chillers' performance could be compared without having to use any flow measurements. Details of this method are given in the Preface section titled "Analyzing Kilowatt-Hours Consumed vs. Average Hourly Outdoor Air Temperature."

ORNL and GSA leadership have elected to include details of both methods of comparing chiller performance in the final report. The findings complement each other, and providing details allows readers the opportunity to fully understand the methods used in this report. Thereby, readers can draw their own conclusions.

It should be noted, however, that while metered energy consumption is accurate to within 0.2% and instrumentation used to calculate tons of refrigeration is accurate to within 3%, when the tolerance of all instrumentation is considered in aggregate, the accuracy of energy consumption rates reported for each chiller, in kw/ton, could vary by +/-8%. When the variance of +/-8% kw/ton is applied to the average measured energy consumption rate of the MBC and VSS chillers, it is possible that the VSS's 11% average energy savings relative to the MBC installed at the Yates Building could vary from as high as +24% to as low as -4%.⁶ The evaluation team remains confident that this overall average level of savings is the best possible representation of real world performance of this technology under field conditions. Both VSS and MBC chillers will deliver performance that significantly exceeds a chiller delivering FEMP compliant energy consumption.

“A/B” Comparison

Figure 1 in the original report summarizes relevant data describing the operating conditions measured for both chillers. The tables were used as tools to track the combinations of chiller percent full load and condenser entering water temperature (EWT) under which each chiller operated, and the time that each chiller spent in each combination. Every effort was made during the study period to provide reasonably equivalent operating conditions as tracked by this table. For 82% of the tracked operating conditions, the two chillers had operating times that were within 1% of each other. For 10% of the conditions, the VSS chiller had more operating time than the MBC unit, and for 8% of tracked load/lift conditions the MBC chiller had higher operating time.

Analysis provided by Danfoss and summarized in Table P-2 showed that during the times the MBC had higher operating time, the MBC chiller was operating with higher condenser water temperatures, which they felt could have a negative effect on the overall characterization of measured energy performance.

As part of the report’s review, the project team conducted an analysis that allowed performance to be compared within each particular band of condenser EWT. Details of this analysis and the results are given further in the Preface in the section titled “Analyzing Kilowatt-Hours Consumed vs. Average Hourly Outdoor Air Temperature.”

Table P-2. Relative operating time that the MBC (aka “centrifugal”) spent operating within each paired conditions of “Chiller Load” and “Condenser EWT” as compared to time spent by the VSS chiller

		Chiller Load (% of Full Load)									
		0.0%	20.0%	30.0%	40.0%	50.0%	60.0%	70.0%	80.0%	90.0%	
		19.9%	29.9%	39.9%	49.9%	59.9%	69.9%	79.9%	89.9%	100.0%	
		0.0% - 19.9%	20.0% - 29.9%	30.0% - 39.9%	40.0% - 49.9%	50.0% - 59.9%	60.0% - 69.9%	70.0% - 79.9%	80.0% - 89.9%	90.0% - 100.0%	
Condenser EWT (°F)	97.5°F	≥97.5°F	-0.0%	+0.0%	+0.0%	+0.0%	-0.0%	-0.0%	+0.0%	+0.0%	+0.0%
	92.5°F	97.4°F 92.5 - 97.4	+0.0%	-0.0%	+0.2%	+0.2%	+0.0%	-0.0%	-0.1%	-0.1%	+0.0%
	87.5°F	92.4°F 87.5 - 92.4	-0.0%	+0.1%	+0.3%	+2.8%	+0.3%	+0.0%	-0.0%	-0.0%	-0.1%
	82.5°F	87.4°F 82.5 - 87.4	+0.0%	+0.0%	-0.0%	+0.1%	+0.0%	+0.5%	+6.3%	-0.7%	-2.5%
	77.5°F	82.4°F 77.5 - 82.4	-0.0%	-0.1%	-0.1%	-0.7%	+1.0%	+9.3%	+3.9%	-7.9%	-1.5%
	72.5°F	77.4°F 72.5 - 77.4	-0.1%	-0.7%	-2.0%	-3.9%	+1.5%	+0.6%	-2.1%	-0.6%	-0.5%
	67.5°F	72.4°F 67.5 - 72.4	+5.8%	-1.5%	-0.4%	-2.2%	-3.4%	-0.4%	-0.2%	-0.2%	-0.2%
	62.5°F	67.4°F 62.5 - 67.4	-0.1%	-0.0%	-0.0%	-0.0%	-0.0%	-0.1%	-0.1%	-0.1%	-0.0%
	57.5°F	62.4°F 57.5 - 62.4	-0.0%	-0.0%	-0.0%	-0.0%	-0.0%	-0.0%	-0.0%	-0.0%	-0.0%
		57.4°F ≤57.4°F	-0.0%	+0.0%	+0.0%	-0.0%	-0.0%	+0.0%	-0.0%	-0.0%	+0.0%

±1.00%	centrifugal higher operating time
±1.00%	nearly equal operating time
±1.00%	centrifugal lower operating time

⁶ To achieve a result of either 24% or -4% energy savings, temperature, flow, and kilowatt measurements would have to err in a single direction on one chiller, while erring in the opposite direction on the other chiller. Statistically, this is highly improbable.

Data Analysis

Figure P-1 (Figure 3 in the report) shows the MBC and VSS chillers' instantaneous energy consumption points. It illustrates the data sets that compare each chiller's energy consumption rate in kilowatts per ton over the range of cooling capacity, given as "percent full load."

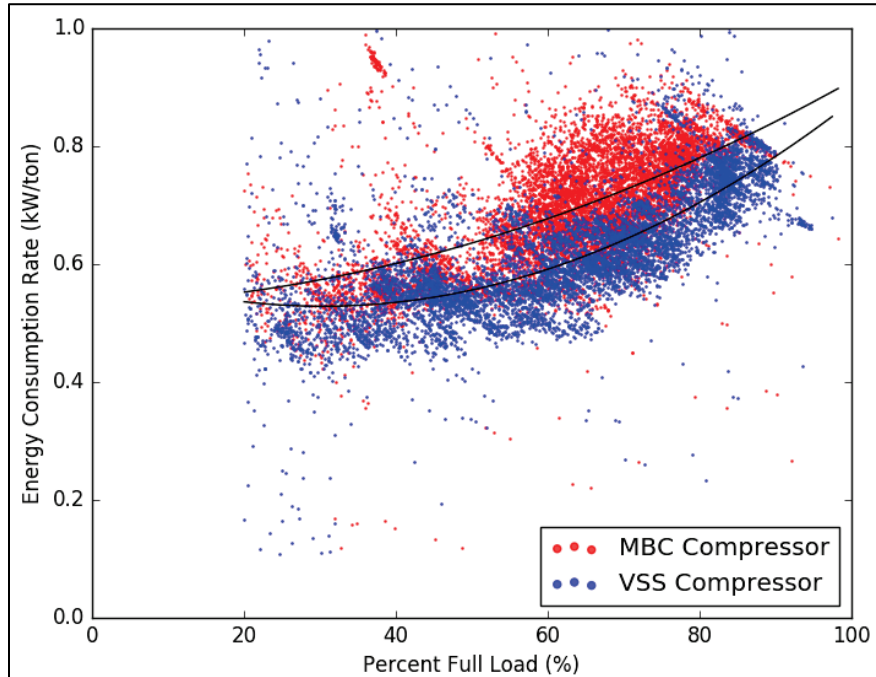

Figure P-1. Chillers' instantaneous energy consumption points (20% to 100% full load).

The data points show that energy consumption rates for each percent full load have a one magnitude variance, ranging from 0.1kw/ton to 1.0kw/ton. This variance is attributable to the real-world dynamics of constantly changing cooling load and resulting changes in power input to the motor to change the cooling capacity provided by the evaporator section. These transition periods cause the energy consumption rate to vary significantly from an idealized, laboratory measured single curve across the range of percent full load (such as the Integrated Part Load Value (IPLV) metric) into a shape more resembling a cloud.

These data show that the median of measured points is between 0.6 and 0.7 kw/ton, whereas both chillers' IPLV ratings are in the 0.32–0.33 kW/ton range. This variance is accounted for by the nature of how IPLV is measured. In contrast to field conditions, IPLV represents the steady state performance of a chiller as measured in a laboratory environment under tightly controlled conditions of a constant cooling load under constant water flow and temperature conditions. Under field conditions, cooling demand is constantly changing, requiring a chiller to adapt dynamically. Chilled water flows and temperatures will rarely be exactly equal to those used in the standards to calculate IPLV. Because a chiller rarely if ever reaches an idealized steady state of operation, its kw/ton performance varies considerably, and is typically higher, than when measured in the lab.

Summarizing Field Results

To summarize the difference between the two "clouds" of data points, and to enable calculation of difference in energy consumption rates, researchers applied a 2nd order polynomial curve fit to each data set which was superimposed on the graph. The equations for each data set are shown below.

$$\text{VSS Chiller: } Y = 7.15078525e-05 \times X^2 - 4.34458454e-03 \times X + 5.94514674e-01$$

$$\text{MBC Chiller: } Y = 3.39824395e-05 \times X^2 + 3.97657265e-04 \times X + 5.30865291e-01$$

These equations were used to estimate the average energy consumption rate that would be found at certain points of percent full load. These curves were included in Section V.A. of the report and represent a depiction of results that were measured in the Yates Building and could (broadly, and within the range of error) be considered as indicative of results that would be measured in other locations. For details of the calculations, Section V.A. should be referenced.

To provide additional insight into the reliability of this data summary, a 95% confidence interval was calculated for the two polynomial equations that estimate mean energy consumption rates in Figure P-1. This confidence interval is superimposed as gray shading around each curve in Figure P-2.

The confidence intervals shown on Figure P-2 indicate that if 100 more sets of 20,000+ data points were taken from the Yates Building chillers, and a second-order polynomial curve fit applied to the data sets, in 95 of those tests the polynomial curve fit would fall within the shaded areas shown on the graph.

(Note: The gray area is best seen around the 20% Full Load and 95% Full Load areas of the graph, where fewer data points were available.)

To further bound the level of uncertainty associated with field-measured data presented in the report, a second statistical method was applied to the two data sets in Figure P-1. This method is known as a LOcal RegrESSion (aka “LOESS”) analysis. A LOESS analysis calculates the mean value of the data points over a certain segment of the x-axis. It also calculates a 95% confidence interval of mean Y-values that would be found through repeated tests over that same segment. The analysis then assembles these values into a curve of mean values with the associated confidence interval and superimposes these curves onto the respective scatter plots.

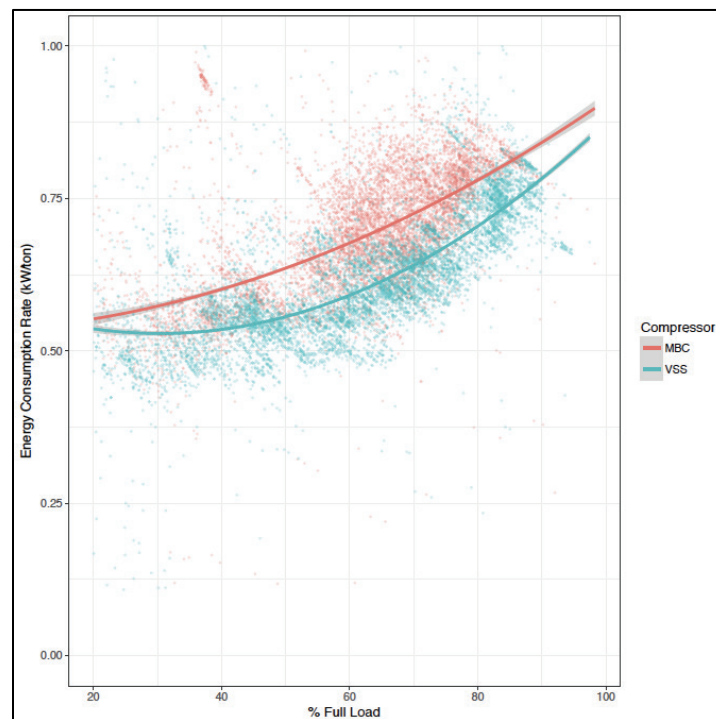

Figure P-2. 95% confidence interval around polynomial curve fit.

Figure P-3 shows the LOESS analysis that was applied to the data sets shown in Figure P-1.

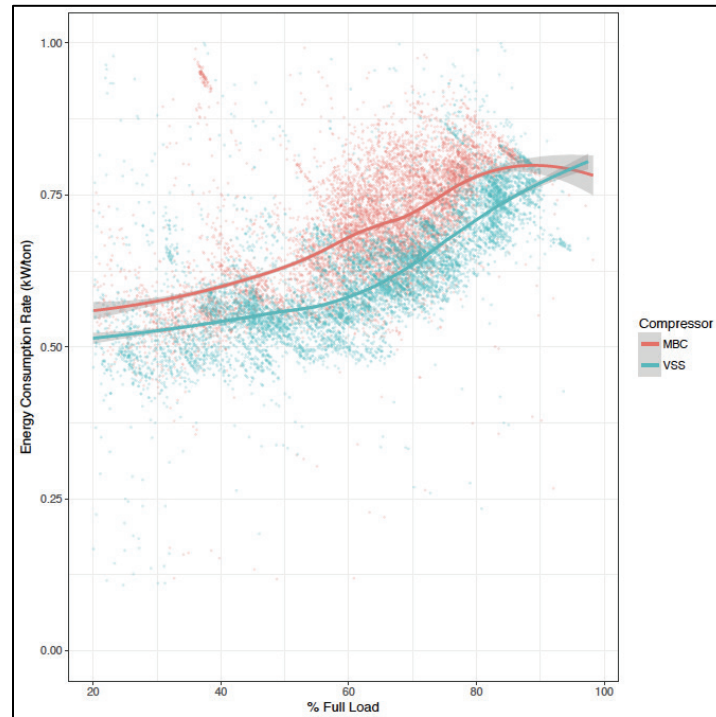

Figure P-3. LOESS analysis with 95% confidence interval.

Two points need to be made about the LOESS analysis diagram. First, between 30% and 85% full load, the lines for each data set are very close to those found in Figure P-1. Second, the confidence interval in this range is very narrow, which indicates a high probability that in repeating this test, the mean Y-values from those tests would be very close to the mean Y-values calculated from the test at the Yates Building.

In summary, both the LOESS analysis and confidence interval agree very closely with the analysis presented in the report and summarized in Figure P-1. The curves follow very similar shapes, and there are sufficient data points to have confidence that the average kw/ton for each chiller is very close to the calculated curves.

Chiller Plant Energy

The project plan for this study focused on documenting and analyzing the performance of two individual chiller technologies. As noted in Section VI.B. of this report, the measured energy consumption rate of a chiller is one of multiple factors that impact the overall energy cost associated with providing cooling to a facility. The entire chilled water system includes other energy-consuming equipment such as condenser and chilled water pumps and the cooling tower. The performance of this equipment can vary widely from site to site. Because the energy efficiency of a chiller is the largest single contributor to the overall efficiency of a chiller plant, selection of the proper chiller by a qualified mechanical engineer is required to optimize the overall efficiency of the chilled water plant.

Analyzing Kilowatt-Hours Consumed vs. Average Hourly Outdoor Air Temperature

During the review process, the project team applied an alternative M&V method to see if it would corroborate findings originally published in GPG-031. This analysis is based upon a protocol found in “M&V Guidelines:

Measurement and Verification for Performance-Based Contracts, Version 4.0,”⁷ published by the Department of Energy’s Federal Energy Management Program. Table 4-1 of the M&V guidelines describes an “Option B” M&V method and says, “This option is based on short-term, periodic, or continuous measurements of baseline and post-retrofit energy use (or proxies of energy use) taken at the component or system level.”

When applied in an energy saving performance contract (ESPC) that involves a new chiller, this option is frequently applied by correlating energy usage of the baseline and new chillers to the concurrent outside air temperature (OAT). Given that the project had already gathered power consumption data that could be compiled into hourly data points, and given that outside air temperature data are available from the National Weather Service at Reagan National Airport less than 2 miles from the site, it is appropriate to apply this method to compare the energy performance of the two chillers at the Yates Building.

The VSS and MBC data sets graphed in Figure P-1 were used in this analysis. The sets were parsed in the following fashion.

- The original data points shown in Figure P-1 were gathered in 5-minute intervals. In the new analysis, the data were filtered into points that represented 1-hour time blocks. To translate into one of the new data points, there had to be sufficient data that showed that the same chiller had operated for all twelve 5-minute blocks within the same hour.
- For each chiller’s 1-hour block that contained twelve complete data points, the power measurements were averaged to determine the total energy consumption (measured in kilowatt-hours) during that hour.
- Hourly average outdoor air temperatures were gathered from National Weather Service data for Reagan National Airport. The airport is less than 2 miles from the site. The same temperature data set was used for both chillers’ energy consumption graphs.
- The hourly energy consumption was graphed against the average hourly outside air temperature for each chiller.
- The new data set was further divided into three separate graphs based upon the condenser EWT during each hour. The bins used to divide the graphs are the same bins used in Table P-2, with focus being on the following three bins:
 - EWT between 67.5°F and 72.5°F
 - EWT between 72.5°F and 77.5°F
 - EWT between 77.5°F and 82.5°F
- These specific EWT bins were selected for three reasons.
 - First, when the 5-minute data points were compiled into 1-hour points, bins with other EWTs did not have sufficient 1-hour points to create any meaningful graphs.
 - Second, within these three EWT bins are five of the seven boxes shown in green within Table P-2. The green boxes identify the sets of conditions within which the MBC had slightly more operating

⁷ U.S. Department of Energy, Federal Energy Management Program (November 2015), “M&V Guidelines: Measurement and Verification for Performance-Based Contracts,” Version 4.0. Available at https://energy.gov/sites/prod/files/2016/01/f28/mv_guide_4_0.pdf.

time than the VSS chiller. The boxes identified in green tended to have higher condenser EWT, and Danfoss felt that operating the MBC unit a greater time under these conditions would have skewed the overall findings such that its performance looked less favorable relative to the VSS chiller's performance. By focusing on the chillers' respective performance within these individual narrow 5°F bands, the impact to the aggregate performance is negated, and their performance can be directly compared, regardless of any disparity of run time.

- Third, these three EWT bins contain eight of the nine sets of conditions identified in red within Table P-2. The red boxes represent conditions in which the MBC chiller operated somewhat less than the VSS chiller. The red boxes tended to be grouped where there was lower condenser EWT. As with the second bullet point above, Danfoss felt that operating the VSS chiller slightly more when the EWT was lower would have given it an advantage when the two chiller's aggregate performance was compared. As with the point above, the impact of these red boxes on aggregate performance is negated when focusing on individual bins.

Each bin is defined by a band of condenser EWT that is only 5°F wide. By dividing the data into these bins, and comparing the chillers' performance to each other only under the conditions within each bin, the project team can draw inferences that will address the concern raised by Danfoss and discussed in the section above titled "A/B' Comparison."

Figures P-4 through P-6 show the three graphs that were produced using the above method. Each graph has a second-order polynomial curve that was fit to the respective chiller's data set and which represents a mean value for that set. Also, there is a shaded area around each curve that shows the 95% confidence interval for the mean value curve of that respective data set.

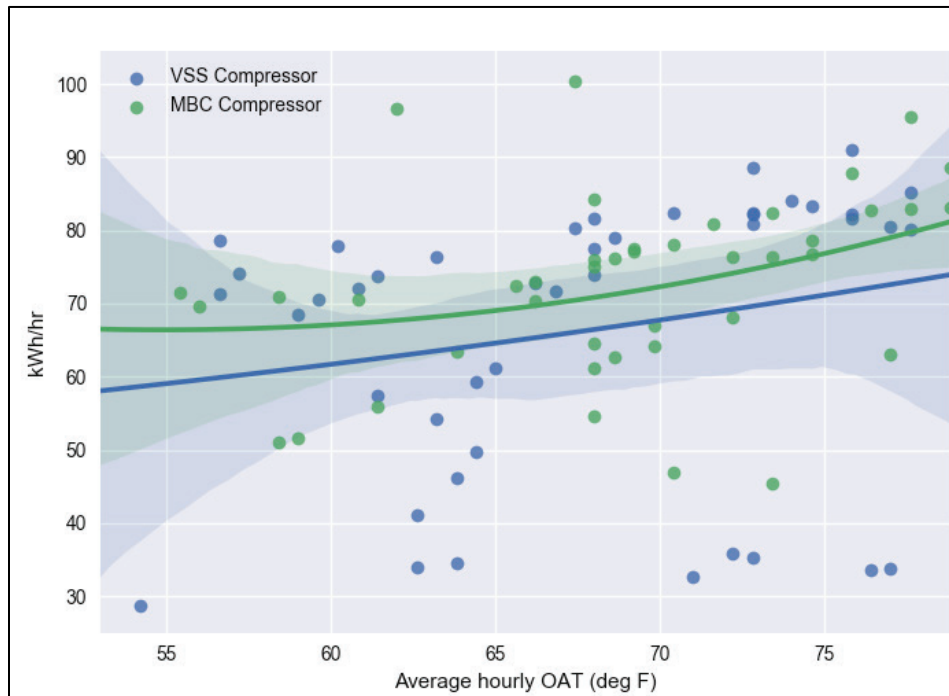

Figure P-4. Energy consumed (in kilowatt-hours) per hour when condenser EWT is between 67.5°F and 72.5°F.

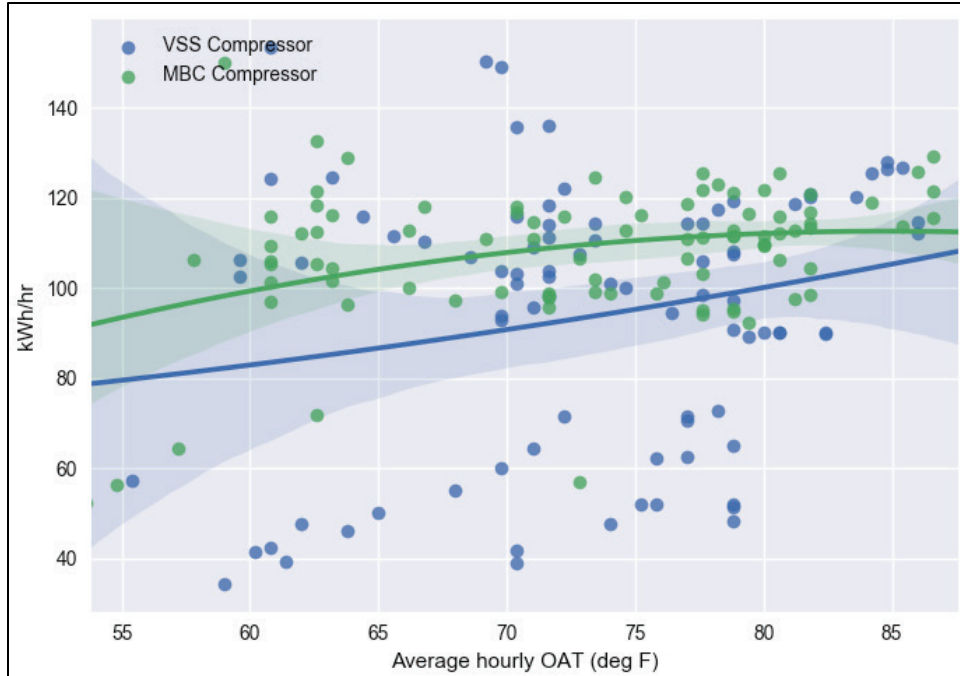

Figure P-5. Energy consumed (in kilowatt-hours) per hour when condenser EWT is between 72.5°F and 77.5°F.

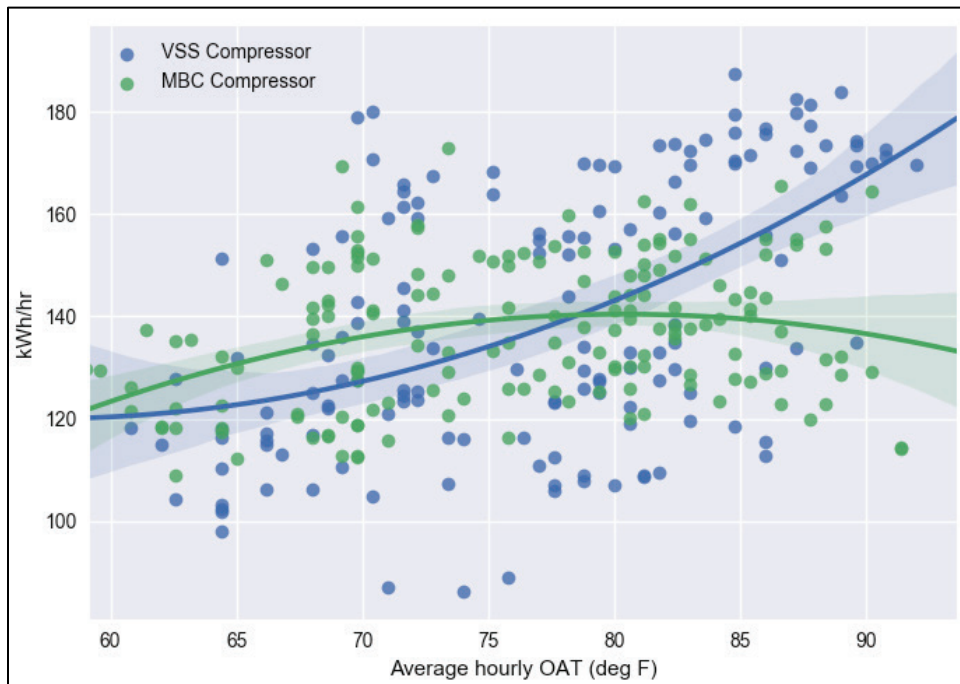

Figure P-6. Energy consumed (in kilowatt-hours) per hour when condenser EWT is between 77.5°F and 82.5°F.

Figures P-4 through P-6 show that on average, the VSS chiller consumed fewer kilowatt-hours of energy per hour than the MBC chiller, except when the outside air temperature and condenser EWTs were at their warmest.

To quantify any difference in energy consumption, the average energy consumption values along each curve were weighted based upon the number of times that the respective OAT occurred on the x-axis. The differences are noted below.

- When the EWT was between 67.5°F and 72.5°F, the MBC chiller consumed 7.7% more electricity than the VSS.
- When the EWT was between 72.5°F and 77.5°F, the MBC chiller consumed 15.9% more electricity than the VSS.
- When the EWT was between 77.5°F and 82.5°F, the VSS chiller consumed 0.8% more electricity than the MBC chiller.
- When energy savings from the three graphs are averaged and weighted based upon the number of points in each graph, the VSS chiller used approximately 3.4% less energy than the MBC chiller during this time period. This finding is within the variance of the initial finding of 11% energy savings from the VSS chiller.

With respect to the Danfoss assertion that having more data points with the MBC chiller operating at higher condenser EWT might have skewed results, Figures P-4 through P-6 show that as the EWT rose into the 77.5 to 82.5°F range, the MBC chiller actually started to perform favorably relative to the VSS. Therefore, if gathering more MBC data points at higher EWTs had any impact on the aggregate comparison of the two units, it would have made the MBC chiller's performance look better compared to the VSS unit's, not worse.

The above analysis used no flow readings. This was purposely done as the accuracy of the field methodology used to calculate flow readings has been debated between various parties reviewing this report, while the accuracy of electrical power readings is unquestioned.

This analysis corroborates, by a means separate from that used in the original report, the original report's finding. That is, that at the Sidney Yates Building, on average, the VSS chiller used less electricity than the MBC chiller.

First Cost Comparison

The purchase price for the MBC chiller in this report, \$185,000, was based upon the actual price paid by GSA when the unit was purchased through the federal contracting process.

The VSS chiller's price, \$119,000, was based upon a budget figure provided by the chiller's manufacturer. To verify this value, ORNL used a third party to "ghost shop" the VSS manufacturer. This price was consistent with the value that was originally provided.

These prices are included for reference only and reflect the stated value of the VSS chiller and the actual price that was paid for the MBC chiller at the time of purchase. Note that these prices are a snapshot in time and may not be indicative of current market pricing. The price difference is also for two chillers of different potential total cooling capacities,⁸ though similar IPLVs under the specified load conditions.

⁸ See "MBC Chiller Cooling Capacity" Section for details of the MBC chiller's "potential total cooling" capacity.

ORNL also surveyed other manufacturers who produced chillers that use the MBC and VSS technologies. This survey resulted in a wide variety of prices based upon various features that each manufacturer included on their units.

Condenser Water Temperature Range

The original project plan envisioned manipulating condenser water temperatures at the Yates test bed to create conditions comparable to those found in other climate zones. At the Yates test bed, however, the MBC chiller tripped off when the condenser water temperature rose above 90°F, which was the upper limit specified by the design engineers on this project. Subsequent to publication of GPG-031, Danfoss stated that MBC chillers can operate at any range of condenser water entering temperatures that is specified by the engineer, provided by the specification is made clear at the start of the project. If a wider performance range for condenser water temperature is specified for an MBC chiller, the design engineer should work closely with the vendor to evaluate cost and/or performance trade-offs that might result.

Conclusions

After reviewing all comments received from Danfoss and Daiken in detail, performing additional due diligence on the design of the Yates test bed, including installed equipment and additional data analysis, and subjecting this report to third party review, as described above, the evaluation team affirms the conclusions originally reported in GPG-031: both VSS and MBC chiller technology deliver state-of-the-art performance with rated energy consumption that is more than 35% better than FEMP standards for water-cooled chillers. The evaluation team further notes that GPG test bed evaluations are intended to offer broad guidance, and exact savings figures from this report represent performance at a specific location under unique conditions, and cannot not be rigidly extrapolated and applied to other facilities. The evaluation team underscores a key deployment recommendation from that original report: It is incumbent that any new chiller or chilled water system be evaluated by a qualified mechanical engineering team to ensure that the selected system is optimized to meet conditions at the designated facility.

I. Executive Summary

Executive Order 13693 requires that federal agencies reduce energy intensity by 2.5% annually by 2020. According to the 2007 US Department of Energy Building Energy Database, heating, ventilation, and air conditioning (HVAC) systems represent 39% of building energy consumption. In buildings that use large water-cooled chillers, these devices can constitute a significant portion of energy consumed to meet HVAC demands.

Adopting new HVAC technologies, including advanced water-cooled chillers, provides facilities with the opportunity to make advances in two areas that are vital to meeting HVAC needs: improving cooling reliability and reducing energy consumption. Chiller technologies available today can significantly increase the operating range of the equipment while meeting unique design requirements. They can also help enhance reliable operation in a wider variety of conditions, whether caused by changes in maintenance practice or as new demands are placed on the building.

In this project, the GPG program measured the performance of two water-cooled chiller technologies designed for a 275-ton load:

1. Variable-speed direct drive screw chiller (VSS chiller).
2. Variable-speed direct drive oil-free centrifugal chiller with magnetic bearings (MBC centrifugal chiller, or simply MBC chiller in this report).

The MBC technology is well established and its performance has been documented in a previous GPG study, GPG-009, “Variable-Speed Oil-Free Centrifugal Chiller with Magnetic Bearings” (December 2013). The MBC chiller in this project was used as the baseline standard to which the VSS chiller would be compared. These chillers were installed in parallel in the Sidney Yates Building in Washington, DC. Instrumentation was installed on the chillers to measure and verify performance in 5-minute intervals. Measured parameters included cooling capacity, condenser water temperatures, power consumption, and chiller energy consumption rate in kilowatts per ton.

Also during the evaluation, maintenance records were kept to indicate whether either unit experienced down time or required any special repairs that might indicate a reliability challenge. Finally, the evaluation tracked ongoing conversations with the site operations team to gather their overall impressions of the two units.

During the evaluation, close track was kept of the cooling demand and condenser water temperatures experienced by each chiller. This was to ensure that each unit was operated as equally as possible under a broad range of field operating conditions. Also, in early spring 2016, unusual weather presented the opportunity to start the chillers with a much colder than normal condenser water temperature. Then, during the summer’s peak, the condenser water temperature was allowed to exceed 95°F to see how the chillers might operate in hot climate zones or in the event of a cooling tower failure.

When measured across a broad range of operating conditions, the VSS chiller had an energy consumption rate that was 11% lower than the MBC chiller (savings could range from +24% to -4% due to measurement uncertainty⁹). Using the local unit cost of electricity of \$0.122/kWh and the operating profile experienced at the

⁹ To achieve a result of either 24% or -4% energy savings, temperature flow, and kw measurements would have to err in a single direction on one chiller, while erring in the opposite direction on the other chiller. Statistically, this is highly improbable.

test site resulted in \$3,080/year in energy cost savings. The VSS chiller used on this project had an equipment price that was about \$65,000 less than that of the MBC chiller.

During testing in early spring, the water entering the condenser was as low as 55°F. The VSS was able to start operation without any issues. The MBC manufacturer recommended 65°F as the minimum operating temperature for which the chiller was designed and indicated that starting the MBC chiller at a condenser entering water temperature of 55°F would void the warranty. During the high condenser water test, the VSS chiller operated throughout the range of temperatures, while the MBC chiller reached an operating limit at 95°F.

The MBC chiller manufacturer was contacted about the limits experienced during this evaluation and was asked how well the chiller would perform if placed in an unusually hot or cold climate. The manufacturer’s response was that the chiller could be selected and designed to operate in whatever the normal range for condenser water temperatures was in the site area. The chiller at the Yates Building was designed for Washington, DC, not, for example, Phoenix, Arizona, or Fargo, North Dakota. Based on testing results and this response from the MBC manufacturer, the evaluation team concluded that is incumbent on the engineer designing the chiller plant to provide the chiller manufacturer with the minimum and maximum condenser water temperatures that might be experienced at the site. If the proper temperature range is specified, both the VSS and MBC technologies can provide chilled water without tripping off line due to reaching a high or low temperature limit.

As for maintenance challenges experienced during the evaluation, both machines operated without a mechanical failure. However, the MBC chiller did require a repair to components related to mechanical unloaders. The manufacturer made the repair promptly under warranty.

Based on findings in this study (see Table ES.1), the US General Services Administration recommends broad deployment of both MBC and VSS chiller technology for new installations, end-of-life replacements, and energy savings retrofits in facilities across all climate zones.

Table ES.1. Performance Objectives

Quantitative Objectives	Metrics and Data Requirements	Success Criteria	Test Bed Results
Reduce Energy/Water Use	Sufficient measurement and verification points to measure chiller load, condenser temperature, power input, and efficiency (kw/ton).	Lower kilowatts per ton than comparable magnetic bearing compressor (MBC) chiller under the same conditions.	Variable-speed screw (VSS) chiller consumed 11% less energy than the comparable MBC chiller over the range of operating conditions during this evaluation (savings could range from +24% to -4% due to measurement uncertainty ¹⁰).

¹⁰ To achieve a result of either 24% or -4% energy savings, temperature flow, and kilowatt measurements would have to err in a single direction on one chiller, while erring in the opposite direction on the other chiller. Statistically, this is highly improbable.

Table ES.1. Performance Objectives (continued)

Quantitative Objectives	Metrics and Data Requirements	Success Criteria	Results
Reduce Costs	Purchase price. Installation cost. Maintenance cost.	VSS chiller has a lower overall life-cycle cost than the MBC chiller	At this site, the VSS chiller had a lower purchase price and energy cost than the MBC chiller. Indications are that an operations and maintenance contract at a GSA facility would cost the same whether either chiller were installed at the site.
Reduce Maintenance	Manufacturer’s maintenance recommendations. Maintenance repair tickets.	VSS requires less unscheduled maintenance.	The MBC chiller had repair performed under warranty. The VSS chiller had no mechanical issues.
Qualitative Objectives			
Increase Comfort	Chilled water supply temperature over range of operating conditions	No difference in chilled water supply temperatures	Both chillers provided appropriate temperatures.
Increase Reliability	Continuous operation over entire range of operating conditions.	VSS operates over the same or greater range of operating conditions.	Both chillers operated successfully within the range of conditions for which they were specified. The VSS unit demonstrated an ability to continue operating during excursions outside its specified range of condenser entering water temperature.
Increase Occupant Satisfaction	Hot or cold complaints from occupants. Chilled water supply temperature records.	No complaints from occupants or from operations personnel.	Neither chiller induced any complaints from occupants.

II. Introduction

A. Objectives

Chillers are typically among the largest electrical loads in heating, ventilation, and air conditioning (HVAC) systems. Due to technology improvements, the energy efficiency of chillers has increased more than 20% in the last 15 years,¹¹ while operational flexibility and ease of operation have also increased. Therefore, replacing water-cooled chillers provides a significant opportunity to reduce energy use and achieve appreciable energy efficiency improvement for a relatively large electrical load.

¹¹ANSI/ASHRAE/IES Standard 90.1-2016, *Energy Standard for Buildings Except Low-Rise Residential Buildings*, The American Society of Heating, Refrigerating and Air-Conditioning Engineers, 2016.

Large Δ Efficiency \times Large Horsepower = Very Large Energy Savings Opportunity for Chillers

Most new chiller models will easily outperform 20- to 30-year-old chillers. However, there can be significant efficiency differences between the new chiller models on the market. For this reason, it is important to compare new chillers relative to each other and not just a single type or model relative to the old, inefficient chiller being replaced. Some technologies will save significantly more energy.

It is also worthwhile to evaluate differences in operating ranges and capabilities among the different technologies. Chillers providing greater operating range yield more reliable cooling and less sensitivity to operating challenges that commonly manifest themselves in older buildings. Operators can also leverage pump and system synergies using chillers designed for variable flow and or variable set point control. Given the impact of chiller replacements on energy use reduction and operational reliability, understanding the impact of competing technologies is valuable.

B. Opportunity

Within the US General Services Administration (GSA) real estate portfolio, nearly all large buildings (>100,000 ft²) use a water-cooled chiller of some sort. This trend is true within the commercial sector as well. Therefore, any technology that improves the energy efficiency of a water-cooled chiller has potential to broadly impact energy consumption within these facilities.

Around 2010, a new type of chiller technology became a presence in the market. These chillers used compressors that operated with oil-free bearings. Rather than using conventional lubricants, they operated by levitating the bearings in a magnetic field. Hence, these chillers and compressors were referred to as “oil-free centrifugal chillers with magnetic bearings” or “MBC centrifugal chillers” or simply “MBC chillers.” These compressors use the centrifugal process to provide compression to the refrigerant and can vary their speeds as the chiller load changes. They also use mechanical unloaders to limit refrigerant flow and cooling capacity as demand changes.

In 2013, the GSA Proving Ground (GPG) program published a report that compared performance of the MBC chiller to an existing chiller that used a constant-speed screw compressor. The MBC chiller showed 42% energy savings relative to the existing chiller.¹² The publication of these results had a significant impact on chillers that were purchased for use in GSA facilities.

In 2014, the GPG program requested evaluation of a variable-speed screw (VSS) chiller that uses conventional bearings with a variable-speed compressor that changes speed to match cooling demand. This chiller is purported to offer energy efficiency that is higher than MBC compressor chillers. It is also claimed to be able to operate under a wider range of operating conditions, especially condenser water temperatures, than MBC units.

C. Technology Description

The chiller evaluated during this project is equipped with a positive displacement screw compressor that uses three helical meshed rotors (aka “screws”) to draw a gas into a confined space between the rotors. As they rotate, the gas is forced into a smaller confined volume, thereby raising its pressure. This type of compressor is commonly used in industry, both in refrigeration systems as well as compressed air systems. Until recently, this type of compressor typically operated at a constant speed. This meant that refrigeration

¹²GSA Green Proving Ground, *Variable-Speed Magnetic Levitation Chiller Compressor*, GPG Findings, GPG-009, December 2013; available on the GSA website under [GPG-009 \(https://www.gsa.gov/portal/content/180775\)](https://www.gsa.gov/portal/content/180775).

and compressed air systems had to use a variety of methods to change the unit's operating capacity as its operating requirements fluctuated.

What makes the chiller evaluated in this project unique is that its screw compressor is directly coupled to a variable speed motor. When the motor changes speed, the compressor also changes speed, thereby increasing or reducing the amount of refrigerant being compressed. Because the refrigerant flow rate can be changed by altering the motor/compressor speed, this chiller's capacity can adapt to changing cooling demands without needing the accessories associated with constant speed screw compressors.

The VSS chiller is conventional in other aspects of its operation. It uses R-134a refrigerant and is available in nominal capacities from 175 to 550 tons. It operates with condenser and chilled water flows and temperatures that are consistent with other chillers used in HVAC applications.

Chillers operate within a system that includes other mechanical devices such as pumps and cooling towers. System efficiency improvements like variable-speed pumps are becoming more common. When selecting a replacement chiller, consideration should be given to its ability to support variable flow.

As mentioned before, the VSS chiller is offered in the 175–550 ton range. The MBC chiller is offered in similar cooling capacities. It is possible for both types of chillers to be operated in chiller plants that have only one unit, or multiple units can be installed to optimize service to the given facility. When considering new chillers for a facility, it is critical to conduct a thorough engineering analysis to determine which configuration will best serve facility needs.

III. Methodology

A. Demonstration Objectives

The purpose of this study was to enable the adoption of new chiller technologies by identifying their ability to deliver efficiency and operational flexibility. Two leading technologies were selected for testing in a field environment, operating in parallel in an actual building. To enable the assessment of energy savings across the GSA portfolio, each technology was operated and measured over a wide range of operating conditions, providing confidence that the tested technology would perform in real-world applications.

The demonstration had three primary objectives.

1. **Measure the energy consumption rate of each chiller.** That is, determine how much electrical power (measured in kilowatts) was required to produce a ton of cooling capacity.
2. **Measure the energy consumption rate over the wide range of conditions that might be found at a variety of sites around the country.** The rate was measured across the chillers' ranges of cooling capacity, from 20% to 100% full load. Also, the entering and exiting water temperatures of the condensers were tracked as this has a significant impact on energy efficiency. Site operations personnel worked with the evaluation team to adjust condenser water temperatures higher than normal to evaluate how the chillers would perform in a simulated hot climate zone. Close track was also kept of the percent of full load and condenser water temperature each time an efficiency measure was made. By tracking these data, the evaluation team and site operations personnel attempted to ensure that each chiller was operated for roughly the same amount of time under each set of conditions, thereby allowing a comparison under conditions as close to identical as possible.
3. **Evaluate maintenance issues for the two chillers, and determine how they would impact life-cycle costs.**

B. Criteria for Site Selection

The original criteria for choosing a demonstration site were very straightforward: a GSA office building with the following characteristics.

- A typical mix of usage: private offices, cubicle space, conference rooms, and common areas.
- A need for a new chiller in the 200–400 ton range. (This is a common size range for facilities in both the federal and commercial sectors.)
- An existing chiller to which the new VSS chiller could be compared.
- A supportive management and operations staff who were enthused about the project.

As the project team was searching for sites, a facility was found that met all the above criteria but was planning for a complete chiller plant replacement. This full-plant replacement allowed for two new chillers to be installed. One was a VSS unit, and one used MBC compressors. While such an arrangement was not part of the original test plan, it presented an opportunity to evaluate the VSS unit's performance and compare it to the market's incumbent state-of-the-art chiller technology.

IV. Measurement & Verification Plan

A. Description of Demonstration Site

The Sidney R. Yates Building, located at the corner of Independence Avenue and 16th Street, SW, in Washington, DC, is a 208,000 gross square foot red brick office building constructed in 1880. The building is listed on the National Register of Historic Places and serves as the headquarters of the US Forest Service.

In January 2014, after one year of renovations, the building reopened its doors to the 800 Forest Service employees stationed at headquarters. Renovations focused on occupied spaces and an upgrade to the building automation system.

The existing chiller system included two 350 ton centrifugal chillers (about 30 years old), constant-speed chilled and condenser water pumps, and a 30,000 gallon in-ground concrete cooling tower. In 2014, the building facility management team began planning for a renovated chiller plant—about the same time that the GPG project team was scouting demonstration sites for a VSS chiller evaluation.

Because of the complete chiller plant renovation, there was an opportunity to install both an MBC chiller and a VSS chiller in parallel to each other. The building's new cooling load was calculated and determined to be 275 tons, which would become the specified capacity for each new chiller.

The chillers were installed in parallel. Each was connected to the same chilled water and condenser water loops so that the operating conditions for each would be as close to identical as possible within the field environment.

The Yates Building chiller plant went into operation late in the summer of 2015. Performance data were gathered for a few weeks during that summer and for the entire summer period in 2016.

Because the site is typical of office buildings found in the GSA inventory and located in a moderate climate zone, findings from the Yates Building will be useful to facility managers across a wide range of other GSA

facilities. However, it must be emphasized that each facility should perform its own energy analysis to determine what type of chiller plant will best serve the unique characteristics found at that site.

B. Test Plan

The test plan for this evaluation was very straightforward. As part of the chiller plant's renovation, a comprehensive instrumentation and control system that tracked a multitude of performance parameters was installed. Critical to this evaluation, instruments were installed which could measure the following parameters.

- Condenser manifold entering and exiting water temperatures. Understanding these values facilitated adjusting the condenser water temperature to simulate cooling tower conditions that might be found in different climate zones around the country.
- Chilled water flow rate at each chiller. This value, when combined with the entering and exiting water temperatures, enabled calculation of the instantaneous cooling capacity of the chiller.
- Instantaneous electric power demand for each chiller. This value, when combined with the instantaneous cooling capacity of the chiller, allowed a snapshot of the chiller's energy consumption rate measured in kilowatts per ton (kW/ton). This value is commonly used by the industry to represent chiller performance.

Measurements for the chilled and condenser water temperatures were taken at a point in the piping system that was common to both chillers. By positioning the sensors in this fashion, the project team ensured that the same set of instruments was being used. Flow measurements were taken at each chiller's respective condenser and evaporator section. There was not sufficient space to install an in-line flow meter in the common header, so measuring at each chiller's heat exchanger was the appropriate path forward.

This project did not lend itself to establishing a conventional "baseline" of technology performance in which an existing incumbent technology is operated and measured for a period of time and then the new technology is installed and tested. Rather, both the MBC and VSS chillers were installed as part of the same retrofit. These chillers were then operated in an alternating fashion to meet the facility's daily cooling needs. Data were gathered on each unit in 5-minute intervals during its operating periods. Data were gathered instantaneously at each interval. Data were not averaged over the previous 5-minute period.

As mentioned previously, there was an attempt to give each unit roughly the same amount of operating time under the same conditions. To facilitate this, tables like those shown in Figure 1 were set up to track the number of data points, which were gathered under specific combinations of condenser entering water condition and chiller full load. By doing this, the operations staff could modify chiller plant operations as needed to balance the data gathered on each machine.

Yates Building, VSS Chiller (Data Set #1)										
Condenser EWT (degrees F)	>97.5dF	1	0	0	0	2	1	0	0	0
	92.5-97.4dF	0	1	0	0	0	1	9	8	0
	87.5-92.4dF	16	8	147	3	1	0	2	4	8
	82.5-87.4dF	4	1	20	6	2	2	88	605	376
	77.5-82.4dF	9	14	24	82	204	701	1090	996	295
	72.5-77.4dF	61	151	367	615	730	950	385	96	122
	67.5-72.4dF	233	370	607	879	636	98	31	19	21
	62.5-67.4dF	17	2	4	5	5	11	10	10	2
	57.5-62.4dF	2	1	2	1	2	2	5	3	2
	<57.4	2	0	0	1	1	0	2	2	0
Total	11196	0-19.9%	20-29.9%	30-39.9%	40-49.9%	50-59.9%	60-69.9%	70-79.9%	80-89.9%	90-100%
Chiller Load (% of full load)										
Yates Building, MBC Chiller (Data Set #2)										
Condenser EWT (degrees F)	>97.5dF	0	0	0	0	0	0	0	0	0
	92.5-97.4dF	0	0	21	17	0	0	0	0	0
	87.5-92.4dF	10	14	162	287	34	0	0	0	0
	82.5-87.4dF	5	5	17	13	5	54	727	479	84
	77.5-82.4dF	7	6	14	8	289	1592	1391	105	120
	72.5-77.4dF	42	68	135	163	818	928	137	23	58
	67.5-72.4dF	806	188	515	575	229	49	3	1	1
	62.5-67.4dF	4	0	0	0	0	0	0	0	0
	57.5-62.4dF	0	0	0	0	0	0	0	0	0
	<57.4	0	0	0	0	0	0	0	0	0
Total	10209	0-19.9%	20-29.9%	30-39.9%	40-49.9%	50-59.9%	60-69.9%	70-79.9%	80-89.9%	90-100%
Chiller Load (% of full load)										

Figure 1. Sample tables showing how data on chiller performance were gathered and recorded.

C. Instrumentation Plan

During renovation of the Yates chilled water plant, the site’s building management system was upgraded so that it tracked a myriad of performance data points. To focus on the energy consumption rate for each chiller, the following parameters (Table 1) were closely tracked.

Table 1. Parameters Closely Tracked during the Evaluation

Parameter	Units
Site chilled water return temperature (aka “Evaporator Entering Water Temperature”)	Degrees Fahrenheit
Site chilled water supply temperature (aka “Evaporator Exiting Water Temperature”)	Degrees Fahrenheit
Site condenser water supply temperature	Degrees Fahrenheit
Site condenser water return temperature	Degrees Fahrenheit
MBC evaporator flow rate	Gallons per minute
MBC condenser flow rate	Gallons per minute
VSS evaporator flow rate	Gallons per minute
VSS condenser flow rate	Gallons per minute
MBC power consumption rate	Kilowatts
VSS power consumption rate	Kilowatts

Figure 2 shows the relative positions of the instruments used to track the various performance parameters. The diagram also clearly shows how the chillers operated in parallel on the same condenser water and chilled water circuits that served the facility. This allowed an excellent opportunity to focus on each individual chiller’s performance without having as many outside variables to focus on.

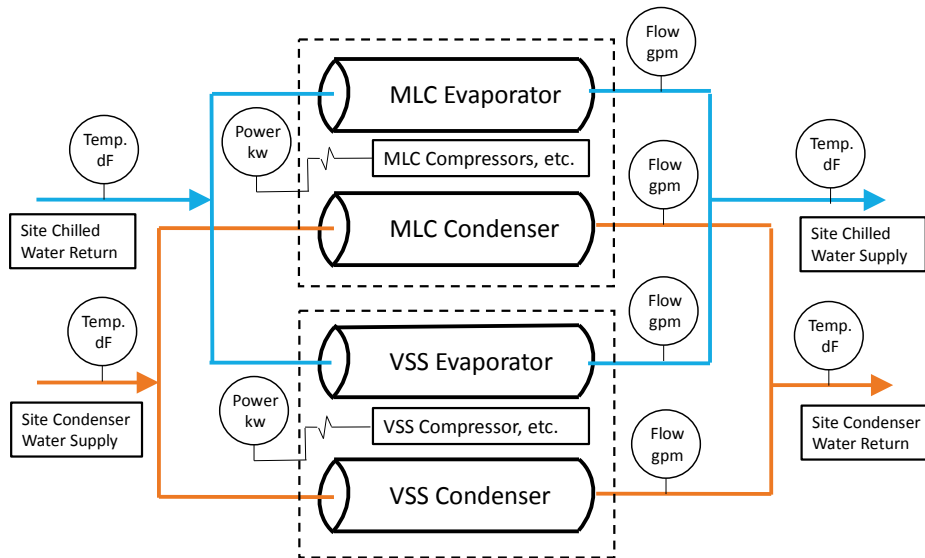

Figure 2. Schematic diagram showing the relative positions of the various instruments used to track performance parameters.[MLC = maglev centrifugal (chiller), an alternate name for the MBC chiller.]

V. Measurement & Verification Results

A. Energy Consumption Rates vs. Percent Full Load

The data collected were assembled into a variety of graphs for analysis. Each graph is discussed in the following paragraphs.

The first graph, shown in Figure 3, assembled the chillers' instantaneous energy consumption points, measured in kilowatts per ton, and plotted them against an x-axis of "percent full load." A curve was then fit to each chiller's data set. Graphs such as this are very common in the industry when looking at a chiller's energy efficiency over the breadth of its cooling capacity.

At the testbed, the VSS consumed less energy than the MBC, though it is important to note that the evaluation results may have been impacted by three factors:

- Measurement uncertainty. When the tolerance of all instrumentation is considered in aggregate, the accuracy of energy consumption rates reported for each chiller, in kW/ton, could vary by +/-8% kW/ton. Overall, the average VSS energy use was 11% lower than that of the MBC but savings could range from +24% to -4%¹³ due to measurement uncertainty.
- Uneven load profiles. As might be expected in a real-world test, the load profiles for the two chillers were not exact. When the MBC had higher operating time, it was operating at a higher load and with higher condenser water temperatures, which could have a negative effect on measured energy performance.

¹³ To achieve a result of either 24% or -4% energy savings, temperature flow, and kilowatt measurements would have to err in a single direction on one chiller, while erring in the opposite direction on the other chiller. Statistically, this is highly improbable.

- Chiller compressor capacity. The 275-ton MBC chiller purchased for this project was scrutinized heavily prior to its installation to ensure that the vendor knew the expectation that they were to provide a chiller with 275 tons of cooling capacity, and the vendor verified it as such. Subsequent to the GPG study, the project team learned that the MBC chiller used on this project has the ability to provide up to 400 tons of cooling capacity. It is not known, and is beyond the scope of this study, to determine what impact, if any, this had on the project's overall findings.

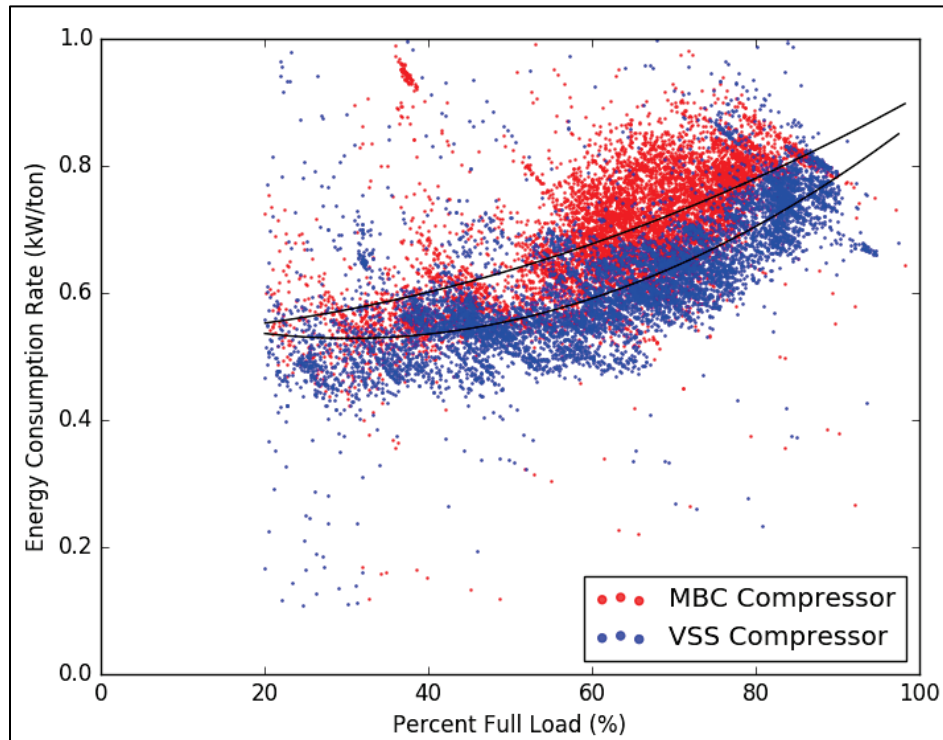

Figure 3. Chillers' instantaneous energy consumption points (20% to 100% full load).

The formulas for each of the curves are given in the equations below. They will be used later to determine the energy consumption rate at specific points on the x-axis.

$$\text{VSS Chiller: } Y = 7.15078525e-05 \times X^2 - 4.34458454e-03 \times X + 5.94514674e-01$$

$$\text{MBC Chiller: } Y = 3.39824395e-05 \times X^2 + 3.97657265e-04 \times X + 5.30865291e-01$$

To quantify the improved performance and its impact at the Yates Building, a second graph, Figure 4, was assembled to show the facility's load profile. It shows the amount of time that each chiller spent operating within bins that are each 10% of each chiller's full load capacity of 275 tons. When the hours in each bin are summed (at the top of each bar in the graph), a realistic picture of the building's operating profile emerges. It should be noted that at no time were both chillers operating simultaneously to carry the facility's cooling load.

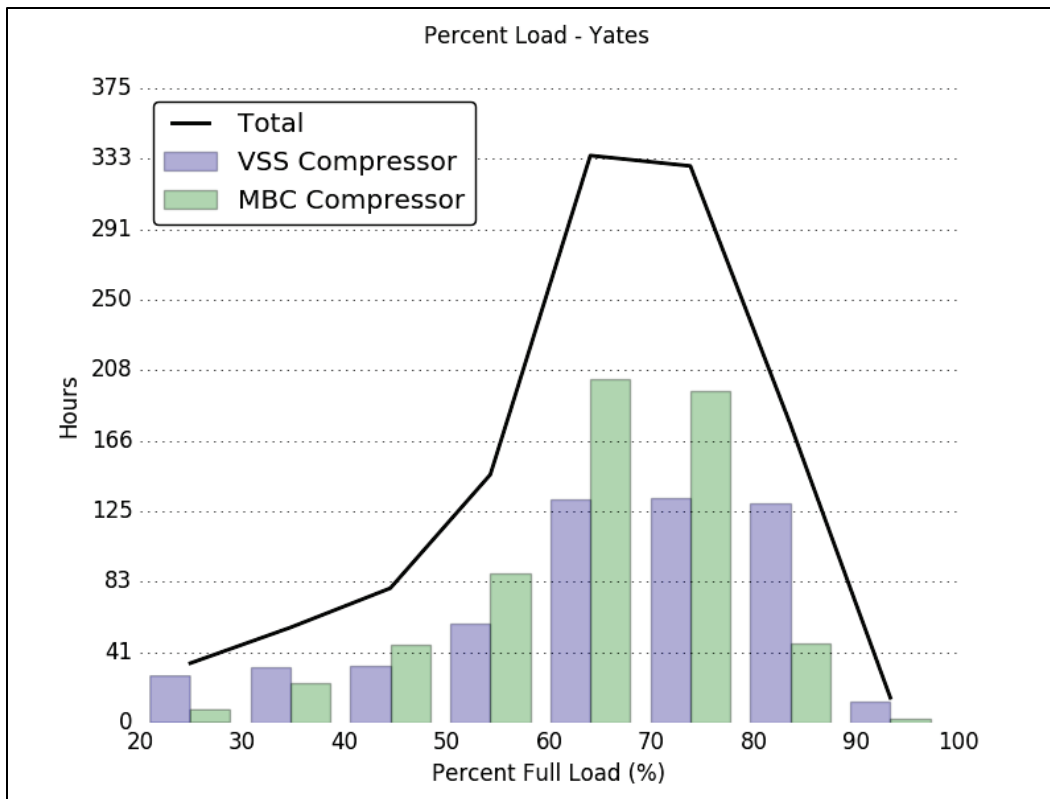

Figure 4. Yates Building operating load profile.

To quantify the average energy consumption rate for each chiller at the Yates Building, the actual run hours in each band from the bar graph above were assembled into the table shown in Figure 5.

Combined Chillers / Total Building % of full load, band width	Midpoint of Band % Full Load	Number of Hours in Band	% of Full Year's Profile	VSS kw/ton at midpoint	Weighted kw/ton	MBC kw/ton at midpoint	Weighted kw/ton
20-30%	25	50.8	3.8%	0.531	0.020	0.562	0.021
30-40%	35	112.3	8.3%	0.530	0.044	0.586	0.049
40-50%	45	153.8	11.3%	0.544	0.062	0.618	0.070
50-60%	55	177.3	13.1%	0.572	0.075	0.656	0.086
60-70%	65	340.3	25.1%	0.614	0.154	0.700	0.176
70-80%	75	329.7	24.3%	0.671	0.163	0.752	0.183
80-90%	85	176.6	13.0%	0.742	0.097	0.810	0.106
90-100%	95	14.8	1.1%	0.827	0.009	0.875	0.010
Totals:		1,355.5	100.0%		0.623		0.699

Figure 5. Average energy consumption rate for each chiller.

The bands were totaled, and then the run hours from each band were divided by the total run hours to give a percent of time that the total building spent operating within each band. This percentage is given in the table's fourth column (percent of full year's profile).

The midpoint of each band was determined and placed in the second column. These midpoints were then entered into the curve fit equations to determine an energy consumption rate in kilowatts per ton for each band. This kilowatt-per-ton value is shown in the fifth column for the VSS chiller, and the seventh column for the MBC chiller.

In the sixth and eighth columns, each bin's kilowatt-per-ton energy consumption rate was multiplied by the percent of time that the building operated within that range. These values were then summed to give a weighted average energy consumption rate for the operating profile at the Yates Building.

For the VSS compressor chiller, the energy consumption rate is 0.62 kW/ton.

For the MBC compressor chiller, the energy consumption rate is 0.70 kW/ton.

This indicates 11% lower energy use for the VSS chiller (savings could range from +24% to -4% due to measurement uncertainty¹⁴).

B. Energy Consumption Rates vs. Condenser Water Return Temperature

The evaluation team then took the same data sets but graphed them slightly differently. This time, the energy consumption rate stayed the same on the y-axis, but the x-axis shows the condenser water return temperatures (Figure 6). This graph was assembled to compare chiller performance under a wide variety of cooling tower conditions. These variations can happen when facilities are located in different climate zones. They can also happen when cooling tower fans fail and the condenser water reaches an abnormally high temperature for the particular region (climate zone).

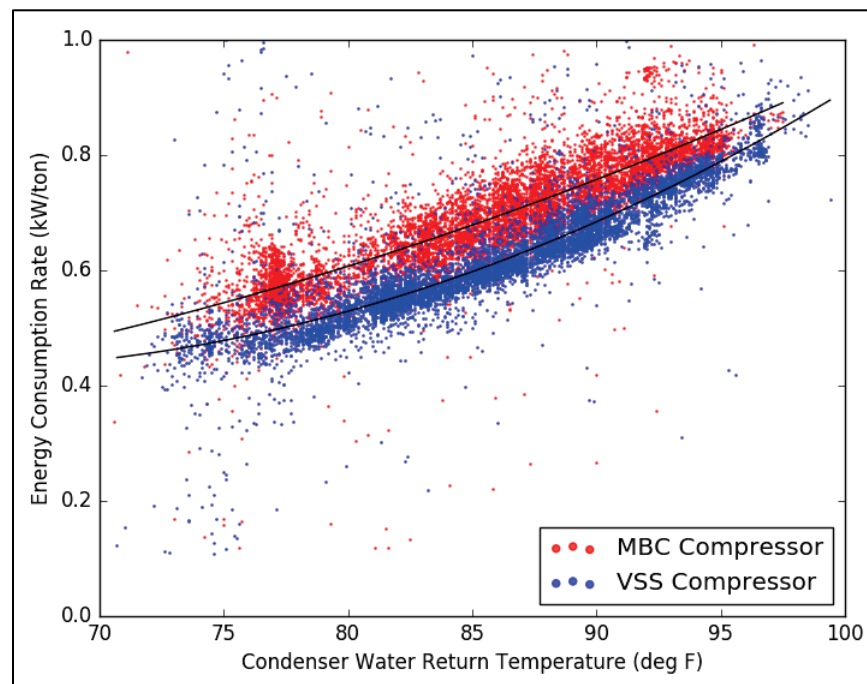

Figure 6. Energy consumption rate vs. condenser water return temperature when the chillers are running at 20%–100% of full load.

Figures 3 and 6 are compilations of all data points, including every combination of percent full load and condenser water return temperature. The graphs in Figures 7–11 were produced in an effort to analyze the data in more detail. For each of these figures, energy consumption rates are shown on the y-axis and

¹⁴ To achieve a result of either 24% or -4% energy savings, temperature flow, and kilowatt measurements would have to err in a single direction on one chiller, while erring in the opposite direction on the other chiller. Statistically, this is highly improbable.

condenser water return temperature on the x-axis for a “slice” of the load. A few notes to help the reader correctly interpret the graphs follow.

Each graph has a curve fit to the data points for each chiller. These curves are not as gentle as the lines shown in the composite graph (Figure 6). This is due to the fact that the graphs in Figures 7–11 have fewer data points from which to fit the curve. Therefore, sharper bends are to be expected. However, the lines do serve to make it visually clear that the VSS chiller has a lower energy consumption rate than the MBC chiller at every point evaluated within the operating range.

The reader also might notice that the condenser water return temperature tends to be lower within the graphs that show data points for a lower percent of full cooling capacity. This is quite normal as lower outside air temperatures cause both events. The building doesn’t need as much cooling when it’s cool outside. Also, the cooling tower works better and provides colder water when the ambient air temperature is lower.

The graph in Figure 7 shows very few data points as the chillers were operating between 0 and 20% of full load. This is typical of a normal facility’s operation as chillers do not often operate within this range.

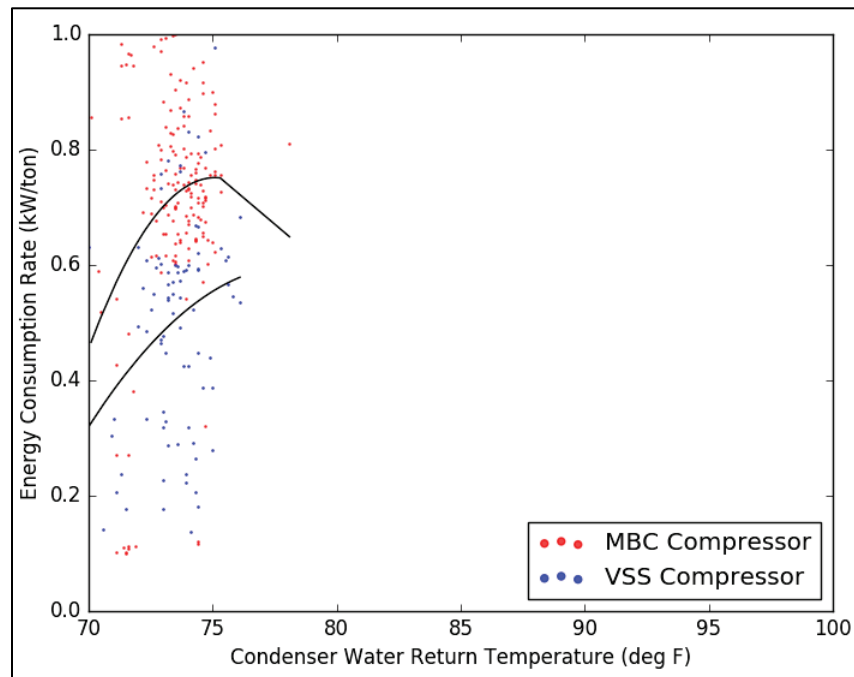

Figure 7. Energy consumption rate plotted against condenser water return temperature when the chillers are operating at 0 to 20% of full load.

The graph in Figure 8, which presents data for the chillers operating in the 20%–40% full load range, shows a larger mass of data points on the left side of the x-axis. This is typical of what would be expected as cooler outside air causes both lower cooling demand and lower condenser water return temperatures.

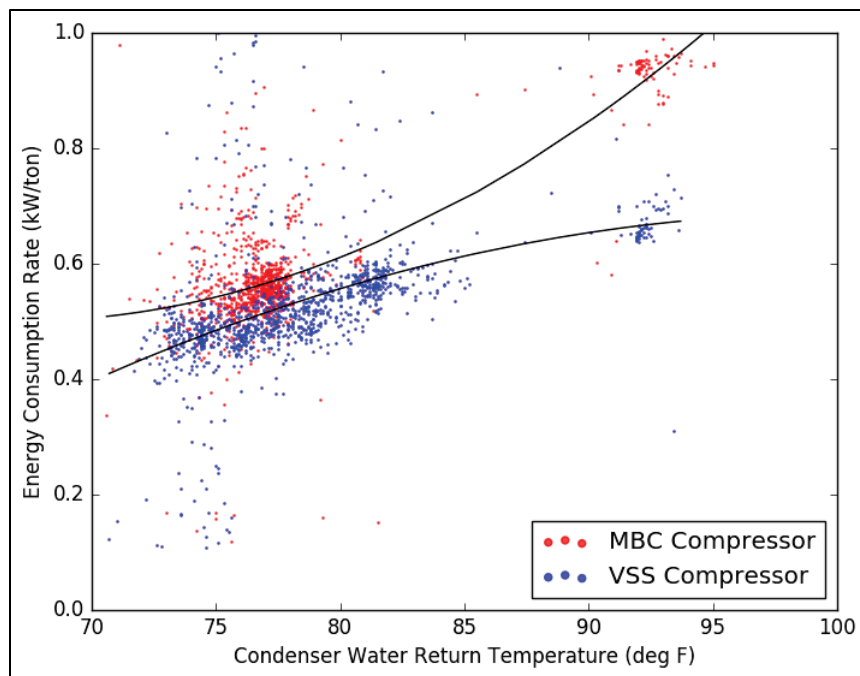

Figure 8. Energy consumption rate plotted against condenser water return temperature when the chillers are operating at 20% to 40% of full load.

However, there are two knots of data points on the right side of the graph between 90°F and 95°F (one for the MBC chiller and one for the VSS chiller). These points occurred during a test when the team deliberately allowed the condenser water temperature to rise to this range so they could evaluate how the chillers would respond under these conditions. As shown, the difference between the two energy use rates increased dramatically. The MBC chiller vendor was contacted about this finding and responded that if one of its chillers were going to be installed in a hotter climate zone, it would be designed for those conditions so that the energy use rate would be lower than on the unit installed at the Yates Building.

The graph in Figure 9, in the 40%–60% full load range, shows the difference between the energy consumption rates of the two units. This operating range is where many chillers spend a significant amount of their time. If a facility is one of those, the VSS chiller could lower the cost of electricity for operating the chiller.

The odd curves in the graph in Figure 10 are due to the small mass of VSS data points that are above 95°F. During one particularly warm period, the facility’s operating staff operated the cooling tower into this range to see how the chillers would respond. The VSS chiller continued to operate normally. However, the MBC chiller tripped a compressor, and the operations staff elected to discontinue the test to prevent any damage to the unit.

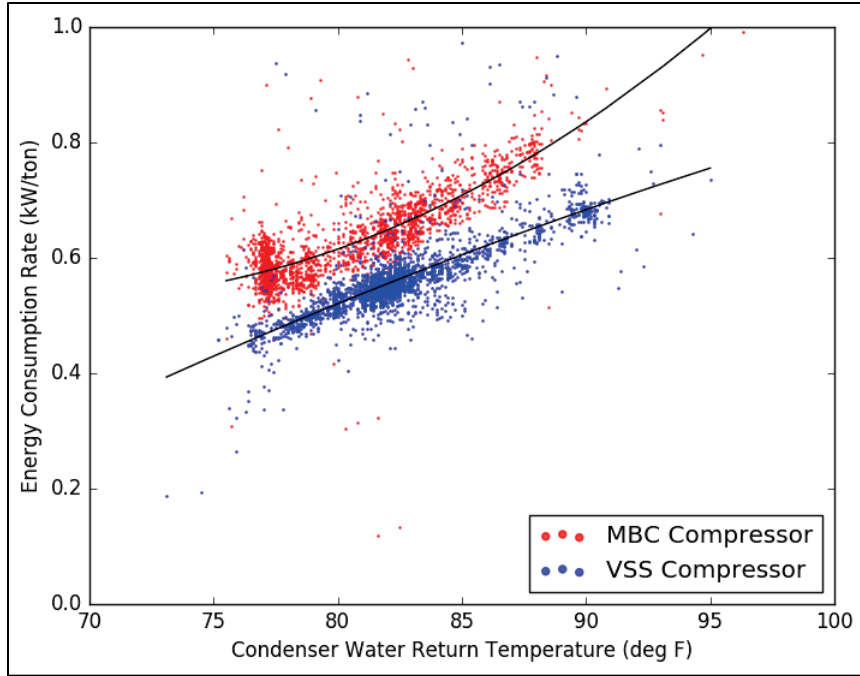

Figure 9. Energy consumption rate plotted against condenser water return temperature when the chillers are operating at 40% to 60% of full load.

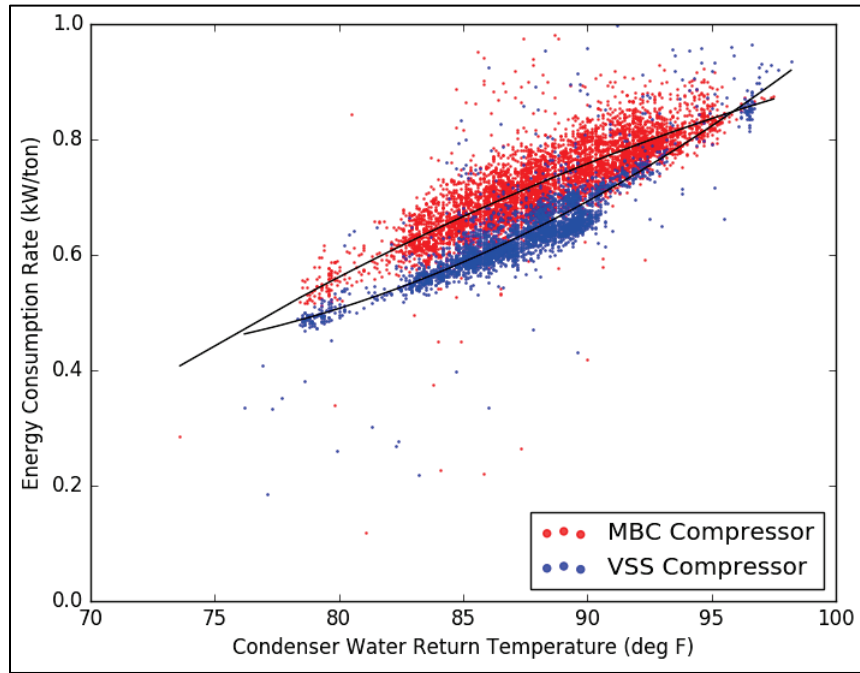

Figure 10. Energy consumption rate plotted against condenser water return temperature when the chillers are operating at 60% to 80% of full load.

The graph in Figure 11 shows chiller performance at near maximum cooling capacity (80% to 100% of full load).

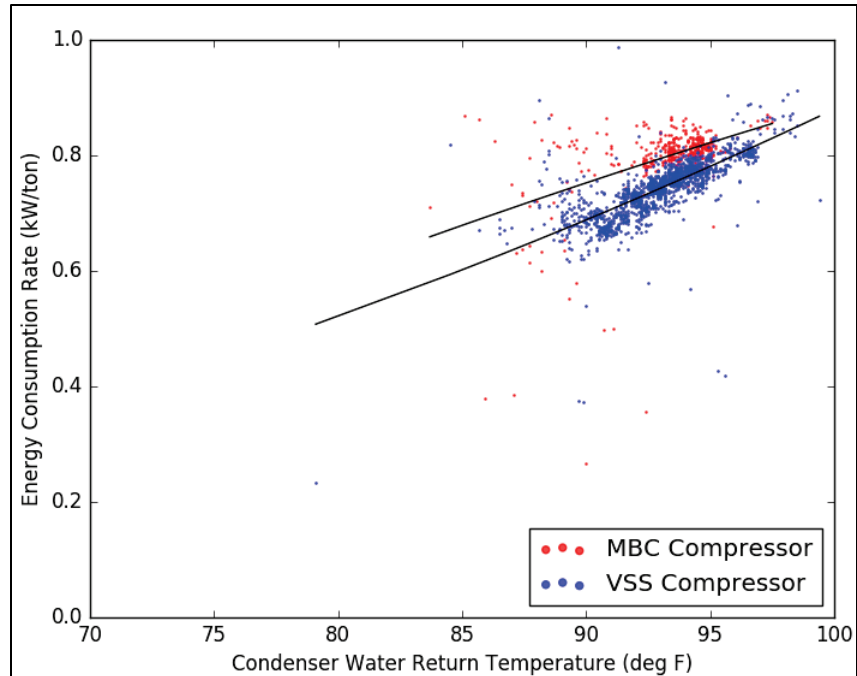

Figure 11. Energy consumption rate plotted against condenser water return temperature when the chillers are operating at 80% to 100% of full load.

C. Operating with High and Low Condenser Water Temperatures

As mentioned previously in this report, among the evaluation’s goals was to determine how well the chillers would perform in areas of the country that are hotter or colder than Washington, DC. The main impact that these different climates would have on the chillers would be higher or lower condenser water temperatures. Therefore, the project sought to create such temperatures within the cooling tower system at the Yates Building.

As fortune would have it, in early 2016 there was a series of unusually warm days during which the building needed the chiller system turned on. However, the cooling tower basin water was still at 55°F, which is below the recommended operating parameters of both chillers. Site operations personnel contacted each chiller manufacturer to learn how to do a start-up under these conditions.

The MBC manufacturer recommended not doing a start-up to avoid causing damage to the unit. According to the manufacturer, the original specifications for purchasing the MBC chiller did not call for the ability to start the chiller when the tower basin water was at unusually lower temperatures. Therefore, the MBC chiller was not designed by the manufacturer to be started under these conditions. According to the chiller’s manufacturer, chillers using the MBC technology can be built to start with a wide range of condenser water temperatures, but the manufacturer has to know the expected parameters at the time of purchase to meet these requirements.

The VSS manufacturer approved doing the start-up with the colder condenser water. Operations personnel proceeded with the start-up, which went smoothly. The tower basin water temperature gradually rose into what would be a “normal” operating range, and chilled water was able to be supplied to the building’s HVAC system.

Conversely, this project wanted to evaluate chiller performance when condenser water temperatures were allowed to run higher than what would normally be seen at the facility. Higher temperatures would be found in a hotter climate zone. They could also occur if the cooling tower fan failed.

Site operations staff reset the cooling tower temperature to 95°F. While operating under these conditions, the MBC chiller had one compressor that tripped off line due to the higher temperatures. After the condenser water temperature was lowered, the compressor was reset and continued operating normally. Again, the MBC chiller manufacturer stated that the technology can operate at higher than normal condenser water temperatures, but the range of expected temperatures has to be specified at the time of purchase.

When the VSS chiller was operated with a 95°F entering water temperature, it continued operating normally without any signs of distress.

Based on findings from these tests, it is incumbent upon the engineer designing the chilled water system to perform a thorough analysis of their site’s specific condenser water temperature parameters to determine the appropriate range to specify for their respective site. The VSS chiller demonstrated the ability to handle wide temperature swings, and the MBC chiller manufacture asserts that their technology can handle wide temperature ranges if they are specified up front in the purchase process. It was beyond the scope of this study to determine if there are purchase price premiums associated with each chiller coming equipped with the ability to continue operating over a wide range of temperatures. The chiller plant design team must account for this cost if it exists, and weigh it against the criticality of their site’s need for continuous chilled water.

D. Energy Savings

Table 2. Energy Savings and Greenhouse (GHG) Emissions Reduction

Site	% Energy Savings (Compared to Baseline)	GHG Emissions Reduction (National Avg. Fuel Mix, M lb CO ₂)
Yates Building	The MBC unit, had it operated the entire cooling season, would have consumed approximately 168 Mwh of electricity. The VSS unit would have consumed approximately 150 Mwh. This is approximately an 11% energy savings compared to the baseline MBC unit at the Yates Building (savings could range from +24% to -4% due to measurement uncertainty)	22,300 lb of CO ₂ equivalent, based upon the US average CO ₂ equivalent of 1,238.52 lb/Mwh of energy saved

GHG calculation should be kilowatt-hours energy saving × local emissions rate = total emissions avoided.

The total emissions rate is found in column six (CO₂e) of the table on page 1 of the EPA eGrid summary tables (https://www.epa.gov/sites/production/files/2015-01/documents/egrid_9th_edition_v1-0_year_2010_summary_tables.pdf).

E. Cost-Effectiveness Analysis

The chiller is but one component in the chilled water plant that serves the cooling needs of any given facility. Each component (pumps, cooling tower, control sequence, economizer heat exchangers, etc.) can have a

great impact on the equipment costs, installation costs, operating costs, life-cycle costs, and overall economics of the chiller plant.

It is not appropriate to attempt a detailed economic assessment looking at the MBC and VSS chillers in isolation from the total chilled water plant; however, Table 3 offers a simple economic assessment based on this test case.

Any facility management organization considering upgrading or replacing HVAC system chillers should employ a qualified mechanical engineer to do a thorough economic and technical analysis that incorporates all facets of chiller plant design to determine which type of chiller, which combination of components, and what control sequence will best serve facility needs.

Table 3. Economic Assessment

Parameter	MBC Chiller	VSS Chiller
Equipment Cost at the Test Bed	\$185,000	\$119,000
Installation	Both chillers were installed at the same time as part of a chiller plant recommendation. Therefore, there was no distinction between the two in their installed costs.	Both chillers were installed at the same time as part of a chiller plant recommendation. Therefore, there was no distinction between the two in their installed costs.
Maintenance	No measurable difference in scheduled maintenance costs. (See text in Section V.H. for details.)	No measurable difference in scheduled maintenance costs. (See text in Section V.H. for details.)
Energy Saved	Baseline	11% savings relative to baseline (savings could range from +24% to -4% due to measurement uncertainty).

F. Occupant Satisfaction

Both chillers provided chilled water at appropriate temperatures to the Yates Building. There was no noted change in customer satisfaction during this test.

G. Installation and Commissioning

Installation for both chillers went smoothly. There was no difference between the two units during the installation and commissioning phase.

H. Operations & Maintenance

As for maintenance challenges experienced during the evaluation, both machines operated without a mechanical failure. However, the MBC chiller did require repair of a component. The manufacturer made the repair promptly under warranty.

When evaluating ongoing scheduled maintenance costs, GSA requires that its site operations and maintenance (O&M) contractors actually propose to charge less for a certain chiller before they can claim that its maintenance costs are lower than a competing type. In the case of comparing scheduled maintenance costs of VSS vs. MBC chillers, the evaluators could find nothing definitive that would indicate that one chiller had lower maintenance costs than the other.

The VSS chiller has only been installed at one GSA site (the Yates Building) to date, and that building's O&M contract did not change due to its installation.

Some facility managers who have longer term experience with MBC chillers indicated that the MBC chillers would have lower maintenance costs due to the fact that these chillers use no oil in their compressors. Intuitively there is merit to this assertion, but no O&M quotes have been provided to quantify any maintenance cost savings.

Other facility managers posited that while there might be a slightly lower cost with the MBC chiller, it would be so small that the overall O&M contract would not change.

The project team discussed this issue with many knowledgeable parties, concluding that any difference in scheduled maintenance cost, if any, would be very slight.

I. Information Technology Security

Neither chiller required special considerations from an information technology security perspective.

VI. Summary Findings and Conclusions

A. Overall Technology Assessment at Demonstration Facility

The assessment of the MBC and VSS chillers was completed under conditions that were as similar to each other as was practical given dynamic field conditions. The results show that both chillers performed effectively, consistent with rated energy consumption that is more than 35% better than FEMP standards for water-cooled chillers. In summary, GSA recommends that both MBC and VSS chiller technologies be considered when a facility is considering the purchase of a new chiller.

B. Lessons Learned and Recommendations

Importance of Proper Chiller Plant Design and Commissioning

The chillers are but one component in the equipment that provides chilled water to a facility. There are pumps to move chilled and condenser water, a cooling tower to reject heat from the condenser water loop, possibly heat exchangers to provide free cooling when appropriate, and a host of ancillary equipment all of which will impact the overall success of the plant.

When a facility management organization is faced with either replacing a chiller or designing an entirely new chiller plant, it is critical that it use the services of an engineer who is qualified and experienced in designing chiller plants. The engineer will be able to make a detailed assessment of the facility's needs and look at all components of the chiller plant to optimize how they work together to maximize both the operational and economic benefits to the facility.

As part of the design process, it is important for the facility staff and the chiller plant engineer to ask key questions. Below is a partial list of those questions to help facilities in the early stages of considering a new chiller. It is by no means meant to be all inclusive, nor is it meant to replace the advice of a qualified mechanical engineer.

What is the actual peak cooling requirement of the facility?

For facility management organizations that are simply looking to replace an old chiller at its end of life, there is a reflexive notion to simply purchase a new chiller with the same cooling capacity. However, it is likely

that a facility's actual cooling needs have changed since the original chiller's installation. Added electrical and computer equipment, changing outside air requirements, greater people density, or an entire change in use (office space becoming a data center) can all change the overall cooling requirements. It is critical that a new heat gain/loss calculation be performed to correctly size the new chiller plant.

What is the facility's cooling load profile?

Most office facilities do not spend a significant amount of time at peak cooling capacity. Much of their time is in the 40%–80% peak load range. If a building operates like this, it is important to look at a chiller's partial load efficiency to see whether it has a low energy consumption rate (in kilowatts per ton) at the partial load levels where it will spend much of its time.

By the same token, if a facility operates 24/7/365 with a fairly high and constant internal load, such as at a data center, it would behoove facility management to focus on a chiller's efficiency at maximum capacity.

Determining a building's load profile is fairly straightforward. Simply track the chilled water flow rates and temperature drops over time. These two values are almost always tracked in a building management system. An annual load profile can be calculated with this information using a simple spreadsheet.

What is the cooling tower's typical condenser water supply temperature?

This value is significantly influenced by a building's climate zone. It can have a huge impact on a chiller's overall performance.

During this evaluation at the Yates Building, evaluations were conducted at both cooler and warmer than average condenser water temperatures, and the MBC chiller had difficulty operating outside its design parameters. The MBC vendor indicated that its chillers are custom designed to operate within certain condenser water temperature ranges. For example, a chiller designed for Phoenix, Arizona, would be different from one designed for Fargo, North Dakota. History has shown that when designed for a particular facility's operating conditions, MBC chillers perform reliably.

Condenser water temperature is an important data point to consider when designing a new chiller plant.

What is the local electricity rate structure, both consumption and demand, for the site?

There is a tendency to estimate a chiller plant's energy cost by simply looking at a site's utility bill and calculating its average composite cost per kilowatt-hour (\$/kWh). While this approach is okay for doing very preliminary calculations, it is important to look at the impact of both the consumption charges and demand charges and how they impact the site's average composite cost.

If there are high demand charges within the rate structure, it is possible that thermal storage or some other method of load shifting might be a cost-effective part of a new chiller plant design. Only a thorough technical and economic analysis that includes consumption and demand charges can determine the optimal chiller plant design.

Is there a chiller manufacturer that has a stronger presence in the facility's area?

It is possible that certain manufacturers might be able to provide better service for a chiller based upon their presence within a certain locale.

C. Barriers and Facilitators to Adoption

This evaluation found no barriers to adopting either the MBC or VSS chiller technology at GSA and commercial facilities.

D. Deployment Recommendations

The MBC and VSS chillers are appropriate for deployment across a broad variety of applications within the GSA and commercial portfolios.

Any time a new chiller is required, whether being installed at a new facility or simply replacing a chiller that has reached its end of life, the MBC and VSS chillers are valid options that should be considered.

The VSS chiller's ability to tolerate swings in condenser water temperature may make it especially valuable for critical applications such as data centers, high security facilities, or facilities that must operate 24/7/365. Operations of such facilities can be hampered in the event of a cooling tower failure or other event that causes condenser water temperature to swing unusually high. The VSS chiller demonstrated its ability to tolerate these swings and continue providing chilled water better than the MBC chiller.

However, the MBC compressor OEM states that chillers equipped with their equipment can be designed to tolerate any range of condenser water temperatures. The design engineer has to make sure they specify the extremes that might be experienced at any critical site and communicate same to the chiller vendor.

Proper engineering prudence would then dictate which chiller provides the optimized option for the respective facility.

VII. Appendices

A. Detailed Technology Specification

The images on the following five pages are from submittals for the VSS and MBC chillers that were installed and evaluated at the Yates Building as a part of this test.



AquaEdge Chiller Performance Outputs

Project Name: 23XRV Government 275 ton chiller
 Sales Office: Carrier Strategic Accounts

11/14/2014
 03:45 PM



Tag Name: 275 ton 23XRV

Chiller

Chiller Model _____ 23XRVA6A6NPJR351-
 Starter / VFD _____ VFD - Unit Mounted (STD Tier)
 Refrigerant Type _____ R-134a
 Isolation Valve _____ Installed
 Hot Gas Bypass _____ Installed
 Operation Type _____ Cooling

Cooler

Size _____ A6
 Waterbox Type _____ Marine Waterbox, 150 psi
 Passes _____ 2
 Nozzle Arrangement _____ C
 Tubing _____ Super E3 (SUPE3), .025 in, Copper
 Fluid Type _____ Fresh Water
 Fouling Factor (hr-sqft-F)/BTU _____ 0.00010

Compressor

Size _____ P (PL Opt.)
 Economizer _____ No

Weights

Total Rigging Weight _____ 15791 lb
 Total Operating Weight _____ 21107 lb
 Refrigerant Weight _____ 940 lb

Condenser

Size _____ A6
 Waterbox Type _____ Marine Waterbox, 150 psi
 Passes _____ 2
 Nozzle Arrangement _____ R
 Tubing _____ Spike Fin III (SPK3), .025 in, Copper
 Fluid Type _____ Fresh Water
 Fouling Factor (hr-sqft-F)/BTU _____ 0.00025

Motor

Size _____ J (P comp)
 Line Voltage/Hertz _____ 460-3-60

Output Type	Full Load	Part Load	Part Load	Part Load
Percent Load	100.00	75.00	50.00	25.00
Chiller Capacity	275 Tons	206 Tons	138 Tons	69 Tons
Chiller Input kW	169 kW	85 kW	38 kW	21 kW
Chiller Input Power	0.615 kW/Ton	0.414 kW/Ton	0.278 kW/Ton	0.303 kW/Ton
Chiller COP	5.72	8.50	12.66	11.60
IPLV	0.328 kW/Ton	N/A	N/A	N/A
Cooler				
Entering Temp.	53.97 F	51.48 F	48.99 F	46.49 F
Leaving Temp.	44.00 F	44.00 F	44.00 F	44.00 F
Flow Rate	660.0 gpm	660.0 gpm	660.0 gpm	660.0 gpm
Pressure Drop	13.9 ft wg	13.9 ft wg	14.0 ft wg	14.0 ft wg
Condenser				
Leaving Temp.	94.42 F	81.71 F	69.31 F	67.16 F
Entering Temp.	85.00 F	75.00 F	65.00 F	65.00 F
Flow Rate	825.0 gpm	825.0 gpm	825.0 gpm	825.0 gpm
Pressure Drop	12.4 ft wg	12.7 ft wg	13.0 ft wg	13.0 ft wg
Motor				
Motor Rated Load Amps	244	183	140	123
Chiller Rated Line Amps	252	151	77	45
Chiller Inrush Amps	252			
Max Fuse/CB Amps	500			
Min Circuit Ampacity	315			



AquaEdge Chiller Estimated Acoustic Data

Project Name: 23XRV Government 275 ton chiller
Sales Office: Carrier Strategic Accounts

11/14/2014
03:45 PM

Tag Name _____ 275 ton 23XRV
Chiller Model _____ 23XRVA6A6NPJR351-
Sound Treatment _____ Full Factory Acoustic Insulation

Airborne Sound Pressure, dB

Percent Load	DBA
100	83
75	83
50	77
25	77

The full load and part load DBA values are accurate according to Engineering Data Release.

Notes:

Estimated Sound Pressure Levels - dB re: 20 micropascal.

Sound pressure levels used to develop this program were measured per AHRI Standard 575.

The sound pressure levels were measured in an acoustical free-field, i.e. a non-reflective environment. Field sound measurements can vary significantly as a function of the reflectivity and proximity of nearby surfaces and the presence of other sound sources.

Octave band sound pressure level data, for each of the above specified loads, are available upon request.

The images on the following three pages are from fact sheets on the MBC chiller that was installed and evaluated at the Yates Building as a part of this test. They contain performance information such as that provided on the VSS unit and related information such as electrical requirements.

MAGNITUDE™ Water Cooled Centrifugal Chiller



Job Information Technical Data Sheet

Job Name	Maryn-Sidney Yates
Date	10/14/2014
Submitted By	Dick Shafer
Software Version	09.64
Unit Tag	275 Ton WMC Assembled
Unit FPA#	AUTO_80
Country of Origin	USA



Unit Overview

Model Number	Capacity ton	IPLV kW/ton	Voltage	Drive Type	ASHRAE 90.1	LEED EA Credit 4
WMC400DC	275.0	0.332	460 v / 60 Hz	VFD/Integral	'04, '07 & '10	Pass

Unit

Model Number:	WMC400DCSN25/E3012-HB2C-2/C2612-GB2C-2/R134-DAABR-U				
Approval:	AHRI and ETL / cETL				
Vessel Code:	ASME				
Compressor Quantity	Capacity Control		Refrigerant Type		Refrigerant Weight
2	VFD / Inlet Guide Vanes		R134a		1142 lb
Evaporator					
Entering Fluid Temperature	Leaving Fluid Temperature	Fluid Type		Actual Fluid Flow	Minimum Fluid Flow
53.99 °F	44.00 °F	Water		660.00 gpm	271.6 gpm
Length	Diameter	Number of Passes	Tube		Fouling Factor
			Material	Wall Thickness	
12 ft	30 in	2	Copper	0.025 in	0.00010 °F.ft ² .h/Btu
Condenser					
Entering Fluid Temperature	Leaving Fluid Temperature		Fluid Type		Fluid Flow
85.00 °F	94.36 °F		Water		825.00 gpm
Length	Diameter	Number of Passes	Tube		Fouling Factor
			Material	Wall Thickness	
12 ft	26 in	2	Copper	0.025 in	0.00025 °F.ft ² .h/Btu

Unit Performance

Design											
Capacity ton	Input kW	Efficiency kW/ton	RLA A	IPLV kW/ton	Part Load Efficiency			Evaporator Fluid		Condenser Fluid	
					75% kW/ton	50% kW/ton	25% kW/ton	Pressure Drop ft H ₂ O	Entering Temperature °F	Pressure Drop ft H ₂ O	Leaving Temperature °F
275.0	149.3	0.543	204	0.332	0.412	0.295	0.265	10.8	53.99	7.3	94.36

MAGNITUDE™ Water Cooled Centrifugal Chiller



Unit Performance

Performance Points Rated at AHRI Condenser Relief													
Point #	% of Design Load	Capacity ton	Input kW	Efficiency kW/ton	RLA A	Evaporator Fluid				Condenser Fluid			
						Flow gpm	Temperature		Pressure Drop ft H ₂ O	Flow gpm	Temperature		Pressure Drop ft H ₂ O
							Entering °F	Leaving °F			Entering °F	Leaving °F	
1	100.0	275.0	149.4	0.543	204	660.00	53.99	44.00	10.8	825.00	85.00	94.36	7.3
2	90.0	247.5	123.6	0.500	174	660.00	52.99	44.00	10.8	825.00	81.00	89.30	7.4
3	80.0	220.0	96.7	0.439	138	660.00	51.99	44.00	10.7	825.00	77.00	84.26	7.5
4	70.0	192.5	75.2	0.390	112	660.00	50.99	44.00	10.7	825.00	73.00	79.26	7.7
5	60.0	165.0	56.0	0.340	88	660.00	49.99	44.00	10.7	825.00	69.00	74.29	7.8
6	50.0	137.5	40.6	0.295	60	660.00	48.99	44.00	10.7	825.00	65.00	69.35	7.9
7	40.0	110.0	29.8	0.271	46	660.00	48.00	44.00	10.7	825.00	65.00	68.46	7.9
8	30.0	82.5	21.8	0.264	35	660.00	47.00	44.00	10.7	825.00	65.00	67.60	7.9
9	20.0	55.0	19.5	0.355	33	660.00	46.00	44.00	10.7	825.00	65.00	66.74	8.0
10	10.0	Rating Point not within scope of Chiller - modify Input Conditions [270]											

Service Data

Service Points Rated at AHRI Condenser Relief									
Point #	Superheat Δ °F	Subcooling Δ °F	Evaporator Fluid			Condenser Fluid			
			Temperature °F	Pressure psig	Velocity ft/s	Temperature °F	Pressure psig	Velocity ft/s	
1	1.0	9.5	43.2	38.3	4.3	95.3	114.5	4.2	
2	1.0	8.6	43.3	38.3	4.3	90.1	104.5	4.2	
3	1.0	7.7	43.3	38.3	4.3	85.0	95.3	4.2	
4	1.0	6.7	43.4	38.4	4.3	79.9	86.6	4.2	
5	1.0	5.7	43.4	38.4	4.3	74.9	78.5	4.2	
6	1.0	4.7	43.4	38.5	4.3	69.7	70.7	4.2	
7	1.0	3.8	43.5	38.5	4.3	68.8	69.3	4.2	
8	1.0	2.8	43.5	38.6	4.3	67.8	68.0	4.2	
9	1.0	1.9	43.6	38.6	4.3	66.9	66.7	4.2	
10	Rating Point not within scope of Chiller - modify Input Conditions [270]								

Physical

Evaporator				
Inlet Location	Header Type	Header Material	Tube Sheet Material	Design Pressure (Waterside)
Left	Dished, Flanged	Carbon Steel	Carbon Steel	150 psig
Condenser				
Inlet Location	Header Type	Header Material	Tube Sheet Material	Design Pressure (Waterside)
Left	Dished, Flanged	Carbon Steel	Carbon Steel	150 psig

Electrical

Voltage	RLA (per unit)	LRA* (per compressor)	Power Connection	MCA	MOCP	Lug Size (wires per phase)
460 V / 60 Hz / 3 Phase	204 A	112 A	Single Point	230 A	300 A	(2) 3/0 - 250MCM

* The field wiring must be sized in accordance with the MCA and not the RLA as some selections may be below the minimum required protection.

Drive

Type	Model	Location	Enclosure Type	Motor Protection	
VFD	Integral	Terminal Mounted	NEMA 1	Standard	
Line Reactor	Compressor Circuit Breaker	Disconnect Switch	Power Connection	Short Circuit Current Rating	Approval
Standard	Standard	Standard	Single Point	Standard	ETL, ETLc

MAGNITUDE™ Water Cooled Centrifugal Chiller



Sound (without Insulation)

Sound Pressure									
Load	Overall	63 Hz	125 Hz	250 Hz	500 Hz	1 kHz	2 kHz	4 kHz	8 kHz
100%	83.5	46.0	55.5	65.5	70.5	74.5	76.0	80.0	74.5
75%	82.5	45.5	55.5	65.5	69.5	73.5	76.5	79.0	72.5
50%	81.0	45.0	54.5	64.0	69.0	71.0	74.5	77.5	70.0
25%	77.0	44.5	51.5	61.0	64.5	67.5	73.0	73.0	62.0

Sound Pressure (dB) measured in accordance with ANSI/AHRI Standard 575-2008 ('A' weighted)

Options

Basic Unit	
Packaging:	Bagging only
Knockdown:	Type A; Fully Assembled Bolted Construction
Insulation	
Thermal:	0.75" on evap shell, suction piping, compressor inlet & motor barrel
Control	
Communication Protocol:	BACnet IP
Drive	
Disconnect / Breaker Type:	Disconnect Switch
Ground Fault Protection:	Yes

Warranty

Unit Startup:	Domestic by Daikin Factory Service (Std.)
Standard Warranty:	Domestic, First Year Standard Warranty (Parts & Labor)
Refrigerant Warranty:	1 year R-134a Warranty
Delayed Warranty Start:	None (Startup 12-18 months after ship date)

AHRI Certification



Certified in accordance with the AHRI Water-Cooled Water Chilling Packages Using Vapor Compression Cycle Certification Program, which is based on AHRI Standard 550/590 (I-P) and AHRI Standard 551/591 (SI). Certified units may be found in the AHRI Directory at www.ahridirectory.org

Notes

1. Above RLA values are per Unit.
2. Performance kW values are total kW, unless noted otherwise.
3. Minimum flow is based upon standard condenser water relief and not increased lift due to constant condenser water temperature.
4. The field wiring must be sized in accordance with the MCA and not the RLA as some selections may be below the minimum required protection.
5. The USGBC bases its LEED EA credit 4 calculations for Enhanced Refrigerant Management on the default values for a water cooled centrifugal chiller with a 25-year life, 10% end of life loss and 2% annual leak rate. The gross ARI cooling capacity for the unit is at least 10 tons, and the refrigerant charge is 10 lbs.
6. The LEED result above considers the chiller only. When applying this information for credit or prerequisite compliance the entire building must be considered.
7. Use only copper supply wires with ampacity based on 75°C conductor rating. Connections to terminals must be made with copper lugs and copper wire.

B. Instrument Cut Sheets

Power Monitoring Single-Circuit | Enhanced Power and Energy Meters

Chiller Power Meter, 1 of 2

E5X SERIES

Versatile Energy Monitoring Solution



The E5x Series DIN Rail Meter combines exceptional performance and easy installation to deliver a cost-effective solution for power monitoring applications. The E5x can be installed on standard DIN rail or surface mounted as needed. The Modbus, LON, and BACnet output models offer added flexibility for system integration. The data logging capability (E5xC3 and E5xx5) protects data in the event of a communications or power failure elsewhere in the system. Combinations of serial communication, pulse output, and phase alarms are provided to suit a wide variety of applications. Additional pulse inputs on E5xHx and E50Fx provide an easy way to incorporate simple flow sensors to track gas, water, steam, or other energy forms using a BACnet or LON system.

The E51 models add a bi-directional monitoring feature designed expressly for renewable energy applications, allowing measurement of power imported from the utility grid as well as power exported from the renewable energy source (e.g. solar panels). In this way, a facility administrator can track all energy data, ensuring accuracy in billing and crediting. They are also useful for monitoring loads that use regenerative braking.

SPECIFICATIONS

INPUTS

Control Power, AC 50/60 Hz; 5 VA max.; 90 V min.; UL Maximums: 600 VL-L (347 VL-N); CE Maximum: 300 VL-N

Control Power, DC 3W max.; UL and CE: 125 to 300 Vdc (external DC current limiting required)

Voltage Input UL: 90 VL-N to 600 VL-L; CE: 90 VL-N to 300 VL-N

CURRENT INPUT

Scaling 5 A to 32,000 A

Input Range 0 to 0.333 V or 0 to 1 V (selectable) CTs must be rated for use with Class 1 voltage inputs

Pulse Inputs E5xHx & E50Fx only Contact inputs to pulse accumulators (one set with E5xH2 and E50F2; two sets with E5xH5 and E51F5)*

ACCURACY

Real Power & Energy 0.2% (ANSI C12.20, IEC 62053-22 Class 0.2S)

OUTPUTS

E50B1 & E5xCx Real Energy Pulse: N.O. static**;
Alarm contacts: N.C. static**

Revenue grade measurements

Meets ANSI C12.20 Class 0.2 standards

High reliability

ANSI C12.20 0.2% accuracy, IEC 62053-22 Class 0.2S on E5xxx

Easy installation

DIN rail or screw mounting options

Multiple applications

Real energy output and phase loss alarm output on E50Bx and E5xCx models...one device serves multiple applications

Data logging

Ensures long term data retrieval and safeguards during power failures (E5xC3 and E5xx5)

Wide CT compatibility

Compatible with CTs from 5 A to 32000 A

APPLICATIONS

- Energy monitoring in building automation systems
- Renewable energy
- Energy management
- Commercial sub-metering
- Industrial monitoring
- Cost allocation

E50Bx	Reactive energy pulse 30 Vac**
E5xCx	RS-485 2-wire Modbus RTU (1200 baud to 38.4 kbaud)
E5xHx	RS-485 2-wire BACnet MS/TP (9600 baud to 115.2 kbaud)

E50Fx 2-wire LON FT

MECHANICAL

Mounting DIN Rail or 3-point screw mount

ENVIRONMENTAL

Altitude of Operation 3000 m

Operating Temp Range -30 to 70 °C (-22 to 158 °F)

Storage Temp Range -40 to 85 °C (-40 to 185 °F)

Humidity Range <95% RH noncondensing; indoor use only

WARRANTY

Limited Warranty 5 years

AGENCY APPROVALS

Agency Approvals UL508 (Open Type Device), EN61010-1, California CSI Solar, ANSI C12.20, Cat III, Pollution Degree 2



*10 kV Vac/dc to 4 to 10 Vdc. **30 Vac/dc, 100 mA max. (AC: 50/60Hz).

*The CE mark indicates RoHS2 compliance. Please refer to the CE Declaration of Conformity for additional details.

800.354.8556 | +1 503.598.4564 | sales@veris.com | intl@veris.com | www.veris.com

HQ0001710.M 0117

ORDERING INFORMATION

	E50B1	E50C2	E50C3	E50F2	E50F5	E50H2	E50H5	E51C2	E51C3	E51H2	E51H5
MEASUREMENT CAPABILITY - FULL DATA SET											
Bi-directional Energy Measurements											
Power (3-phase total and per phase): Real (kW), Reactive (kVAR), and Apparent (kVA)	•	•	•	•	•	•	•	•	•	•	•
Power Factor: 3-phase average & per phase	•	•	•	•	•	•	•	•	•	•	•
Present Power Demand: Real (kW), Reactive (kVAR), and Apparent (kVA)	•	•	•	•	•	•	•	•	•	•	•
Import and Export totals of Present Power Demand: Real (kW), Reactive (kVAR), & Apparent (kVA)								•	•	•	•
Peak Power Demand: Real (kW), Reactive (kVAR), and Apparent (kVA)	•	•	•	•	•	•	•	•	•	•	•
Current (3-phase average and per phase)	•	•	•	•	•	•	•	•	•	•	•
Voltage: Line-Line and Line-Neutral (3-phase average and per phase)	•	•	•	•	•	•	•	•	•	•	•
Frequency	•	•	•	•	•	•	•	•	•	•	•
ANSI C12.20 0.2% accuracy, IEC 62053-22 Class 0.2S	•	•	•	•	•	•	•	•	•	•	•
Accumulated Net Energy: Real (kWh), Reactive (kVARh), and Apparent (kVAh)	•	•	•	•	•	•	•	•	•	•	•
Accumulated Real Energy by phase (kWh)	•	•	•	•	•	•	•	•	•	•	•
Import and Export Accumulators of Real and Apparent Energy								•	•	•	•
Reactive Energy Accumulators by Quadrant (3-phase total & per phase)								•	•	•	•
Demand Interval Configuration: Fixed or Rolling Block	•	•	•	•	•	•	•	•	•	•	•
Demand Interval Configuration: External Sync to Comms								•	•	•	•
DATA LOGGING											
Data Logging: 10 16-Bit Configurable (can include Date/Time) Data Buffers			•								
Data Logging: 3 Timestamped 32-Bit Configurable Data Buffers				•	•	•	•				
Store up to 60 days of readings at 15 minute intervals				•	•	•	•				
OUTPUTS											
Alarm Output (N.C.)	•	•	•	•	•	•	•	•	•	•	•
1 Pulse Output (N.O.)		•									
2 Pulse Outputs (N.O.)	•										
RS-485 Serial (Modbus RTU Protocol)		•	•								
RS-485 Serial (BACnet MS/TP Protocol)						•	•				
LON FT Serial (LonTalk Protocol)				•							
INPUTS											
2 Pulse Contact Accumulator Inputs					•	•					•
1 Pulse Contact Accumulator Input				•	•						•

DIMENSIONAL DRAWING

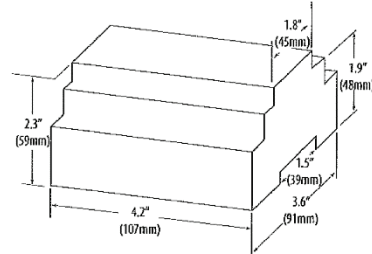

DIN MOUNT CONFIGURATION

Mounting Diagram

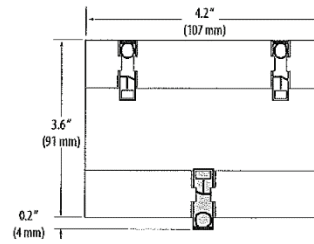

SCREW MOUNT CONFIGURATION

Mounting Diagram

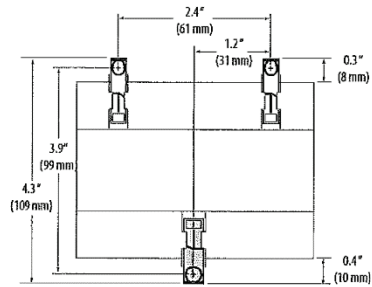



TE-6300 Series Temperature Sensors

Description

The TE-6300 Temperature Sensor line provides economical solutions for a wide variety of temperature sensing needs, including wall-mount, outdoor-air, duct, strap-mount, well-insertion, duct-averaging, and Variable Air Volume (VAV) flange-mount duct-probe applications. The TE-6300 line offers both a metal and a plastic enclosure for the most popular models.

Sensors are available in the following types:

- 1k ohm thin-film nickel
- 1k ohm nickel averaging
- 1k ohm thin-film platinum
- 100 ohm platinum equivalent averaging
- 1k ohm platinum equivalent averaging
- 2.2k (2,252) ohm thermistor
- 10k ohm thermistor, Johnson Controls® Type II

Each sensor is packaged with the necessary mounting accessories to maximize ordering and installation ease and reduce both commissioning time and cost.

Refer to the *TE-6300 Temperature Sensors Product Bulletin (LIT-216320)* for important product application information.

Features

- full line of versatile sensors — supports all your temperature sensing needs from a single supplier: wall mount, outdoor air, duct probe, duct averaging, strap-mount, well insertion, and flange mount duct probe
- single assembly ordering — simplifies ordering; provides a complete assembly in one box
- models featuring an integral NPT Adaptor — increase sensor connection strength, which eliminates the need for a special adaptor
- models with a stainless steel sensor probe — protect the sensor while increasing corrosion resistance
- metal enclosure (TE-63xxM Models only) — meets plenum requirements
- models featuring a retainer for the sensor holder — allow you to lock the sensor holder into the conduit box
- brushed stainless steel mounting plate — offers a durable, aesthetically-pleasing design
- low profile flush mount design — provides a tamper-proof installation ideally suited for schools, sporting complexes, retailers, prisons, and more

All TE-6300 series sensors are two-wire, passive, resistance output devices.

TE-63xxA Models

The TE-63xxA (adjustable length) models:

- provide a thermoplastic mounting flange and gland nut to adjust the length of the probe

- include two hex-head self-drilling screws for mounting
- come equipped with a 10 ft (3 m) plenum-rated cable with 1/4 in. (6.35 mm) female insulated quick-connect terminations on leads

TE-63xxF Models

The TE-63xxF (flush mount) models:

- provide a low profile when installed in an electrical box
- feature thermally isolated sensor from the wall with a foam pad
- offer a rugged stainless steel cover
- provide 22 AWG lead wires with low voltage installation

TE-63xxM Models

The TE-63xxM (metal enclosure) models:

- come with a corrosion-protected steel enclosure with a 0.88 in. (22 mm) hole for a 1/2 in. (12.7 mm) conduit fitting
- include two hex-head self-drilling screws for mounting the duct and duct averaging models
- offer (well models only) either a direct mount or 1/2-14 NPT threaded well sensor holder for mounting in TE-6300W Series thermal wells (Order the thermal well separately.)
- provide optional well sensor holders (order separately) to mount duct models in thermal wells.
- meet UL 1995 plenum use requirements
- offer optional accessory kit (order separately) to replace plastic hole plug and wiring bushing to meet International Mechanical Code (IMC) requirements

TE-63xxP Models

The TE-63xxP (plastic enclosure) models:

- provide a thermoplastic conduit box with 1/2-14 NPT female thread for connecting to conduit
- provide aluminum mounting plate and 1/2-14 NPT threaded hub mounting options for the duct and duct averaging models
- use the 1/2-14 NPT female thread to mount the Outdoor Air models directly to ridged conduit
- provide optional sensor holders (order separately) to mount duct models in thermal wells
- offer an optional accessory metal cover kit (order separately) to replace the plastic cover to meet UL 1995 plenum use requirements
- include a replaceable sensing probe on duct probe, outdoor air, and well insertion models

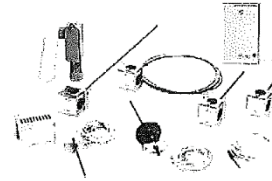

TE-6300 Series Temperature Sensors

TE-63x4P Wall Mount Models

The TE-63x4P (plastic enclosure) models:

- come with a white thermoplastic ventilated cover with a brushed aluminum face plate and a steel mounting plate for surface mounting
- include faceplates for both horizontal and vertical mounting
- offer an accessory mounting kit for mounting to a standard electrical box
- offer optional covers

TE-63xS Models

The TE-63xS (Strap-Mount) models:

- provide a 1/4 in. (6.35 mm) diameter stainless steel probe without an enclosure
- include three cable ties for mounting to pipe up to 2-5/8 in. (67 mm) diameter
- come equipped with a 10 ft (3 m) plenum rated cable
- meet UL 1995 plenum use requirements
- offer an accessory mounting kit for mounting to a pipe up to 1 1/2 in. (38 mm) diameter

TE-63xxV Models

The TE-63xxV (VAV flange mount) models:

- provide a stainless steel mounting flange with two hex-head self-drilling mounting screws
- come equipped with a 10 ft (3 m) plenum rated cable with 1/4 in. (6.35 mm) female insulated quick-connect terminations on leads
- meet UL 1995 plenum use requirements

Repair Information

If the TE-6300 Series Temperature Sensor fails to operate within its specifications, refer to the *TE-6300 Series Temperature Sensors Product Bulletin (LIT-216320)* for a list of repair parts available.

The performance specifications are nominal and conform to acceptable industry standards. For applications at conditions beyond these specifications, consult the local Johnson Controls office. Johnson Controls, Inc. shall not be liable for damages resulting from misapplication or misuse of its products. © 2013 Johnson Controls, Inc. www.johnsoncontrols.com



TE-6300 Series Temperature Sensors (Continued)

Selection Charts

Sensor	Mounting Style	Probe Length in. (mm)	Product Code Number	
Nickel (1k ohm)	Adjustable ¹	8 (203)	TE-6311A-1	
		8 ft (2.4 m)	TE-6315M-1	
		17 ft (5.2 m)	TE-6315V-2 ¹	
	Duct	Adjustable	4 (102)	TE-6316M-1
			8 (203)	TE-6316V-2 ¹
			18 (457)	TE-6316J-1
		Fixed	4 (102)	TE-631GM-1
			8 (203)	TE-631JM-1
			18 (457)	TE-631JP-1
	Flange	Fixed	4 (102)	TE-631GV-2
			8 (203)	TE-631V-2
			18 (457)	TE-631JV-2
	Flush	Fixed	N/A	TE-6310F-0
			N/A	TE-6310F-1
	Platinum (1k ohm)	Outdoor Air	3 (76)	TE-6313P-1
		Strap-Mount	3 (76)	TE-631S-1
		Wall ²	N/A	TE-6314P-1
		Well	6 (152)	TE-631AM-2
			8 (203)	TE-6312M-1
		Adjustable	8 (203)	TE-6351-A
4 (102)			TE-635GM-1	
8 (203)			TE-6351M-1	
Duct		Fixed	18 (457)	TE-6351P-1
			18 (457)	TE-635JM-1
	4 (102)		TE-635GV-2	
Flange	Fixed	8 (203)	TE-6351V-2	
		N/A	TE-6350F-0	
Flush	Fixed	N/A	TE-6350F-1	
		3 (76)	TE-635S-1	
Strap-Mount	3 (76)	TE-635S-1		
Outdoor Air	3 (76)	TE-6353P-1		
Wall ²	N/A	TE-6324P-1		
Well	Fixed	6 (152)	TE-635AM-2	
		8 (203)	TE-6352M-1	

Sensor	Mounting Style	Probe Length in. (mm)	Product Code Number	
Platinum Equivalent	1k ohm Averaging ¹	10 ft (3 m)	TE-6327P-1	
		20 ft (6.1 m)	TE-6328P-1	
	100 ohm Averaging ¹	10 ft (3 m)	TE-6337P-1	
		20 ft (6.1 m)	TE-6338P-1	
Thermistor (2.2k ohm)	Adjustable	8 (203)	TE-6341A-1	
		Duct	8 (203)	TE-6341P-1
		Flange	4 (102)	TE-634GV-2
	Fixed	8 (203)	TE-6341V-2	
		Outdoor Air	3 (76)	TE-6343P-1
		Wall ²	N/A	TE-6344P-1
		Well	8 (203)	TE-6342M-1
	Flush	Fixed	6 (152)	TE-634AM-2
			8 (203)	TE-6341A-1
	Thermistor (10k ohm) Type II	Adjustable	8 (203)	TE-6361M-1
Duct			4 (102)	TE-636GM-1
Fixed		8 (203)	TE-6361P-1	
		18 (457)	TE-636JM-1	
		Flange	4 (102)	TE-636GV-2
Flush		Fixed	8 (203)	TE-6361V-2
			N/A	TE-6360F-0
Outdoor Air		Fixed	N/A	TE-6360F-1
			3 (76)	TE-6363P-1
Strap-Mount		3 (76)	TE-636S-1	
Well	Fixed	6 (152)	TE-636AM-2	
		8 (203)	TE-6362M-1	

- Two TE-6001-8 Element Holders come with the platinum equivalent averaging sensors. Order separately to use with a nickel averaging sensor.
- Order the TE-1800-9600 Mounting Hardware separately to mount the wall unit to a wallbox.

Optional Accessories

Product Code Number	Description
F-1000-182	Thermal Conductive Grease for element wells (8 oz.)
T-4000-xxxx	Wall Mount Cover
T-4000-119	Allen Head Tool for Wall Mount Cover Screws (order in multiples of 30)
TE-1800-9600	Mounting Hardware for mounting the wall mount unit to a wall box
TE-6001-8	Element Holder for mounting an averaging sensor (order in multiples of 10)
TE-6001-13	Metal Cover and Gasket Kit (5 per package)
TE-6300-101	12 in. (305 mm) (1k ohm) Nickel Probe (cut to an appropriate length) ¹
TE-6300-105	12 in. (305 mm) (1k ohm) Platinum Class A Probe (cut to an appropriate length) ¹
TE-6300-103	1/2-14 NPT Plastic Sensor Holder without retainer (order in multiples of 10)
TE-6300-104	12 in. (305 mm) (2.2k ohm) Thermistor Probe (cut to an appropriate length) ¹
TE-6300-613	IMC Kit, Metal Knockout Plug, Metal Clamp Connector (order in multiples of 10)
TE-6300-614	Cable Tie Mounting Kit, 0.50 to 2.625 in. (12.7 to 66.7 mm) Bundle Diameter (10 per package)
TE-6300-615	Cable Tie Mounting Kit, 11 in. (280 mm) Max Bundle Diameter
TE-6300-616	8 in. (203 mm) 1k ohm Platinum Class A Probe
TE-6300-617	3 in. (76 mm) 1k ohm Platinum Class A Probe
TQ-6000-1	4 to 20 mA Output Transmitter for use with the 100 ohm platinum sensor
TE-6300W-102	6 in. (152 mm) Stainless Steel Well (direct mount)
TE-6300W-101	6 in. (152 mm) Brass Well (direct mount with thermal grease included)
TE-6300W-110	8 in. (203 mm) Stainless Steel Well

¹ Cut 12 in. probes to a minimum of 3 in. (76 mm).

The performance specifications are nominal and conform to acceptable industry standards. For applications at conditions beyond these specifications, consult the local Johnson Controls office. Johnson Controls, Inc. shall not be liable for damages resulting from misapplication or misuse of its products. © 2013 Johnson Controls, Inc. www.johnsoncontrols.com



TE-6300 Series Temperature Sensors (Continued)

T-4000 Covers Available for the Wall Mount TE-63x4P Series

Product Code Number	Horizontal Johnson Controls Logo	Vertical Johnson Controls Logo	Thermometer, with °F/°C Scale	Faceplate/Cover Color
T-4000-2139 ¹				Brushed Aluminum/Beige
T-4000-2139	■			
T-4000-2140	■		■	
T-4000-2144		■		
T-4000-2639	■			Brown and Gold/Beige
T-4000-2640	■		■	
T-4000-2644		■		
T-4000-3139	■			Brushed Aluminum/White
T-4000-3140	■		■	
T-4000-3144		■		

1. Without Johnson Controls logo

Technical Specifications

TE-6300 Series Temperature Sensors (Part 1 of 2)		
Sensor Reference Resistance	1k ohm Nickel	1k ohms at 70°F (21°C)
	1k ohm Nickel Averaging	
	1k ohm Platinum	1k ohms at 32°F (0°C)
	100 ohm Platinum Averaging	100 ohms at 32°F (0°C)
	1k ohm Platinum Averaging	1k ohms at 32°F (0°C)
	2.2k ohm Thermistor	2,252 ohms at 77°F (25°C)
	10k ohm Thermistor	10.0k ohms at 77°F (25°C)
Sensor Accuracy	1k ohm Nickel	±0.34°F at 70°F (±0.19°C at 21°C)
	1k ohm Nickel Averaging	±3.4°F at 70°F (±1.9°C at 21°C)
	1k ohm Platinum Class A	±0.35°F at 70°F (±0.19°C at 21°C), DIN Class A
	1k ohm Platinum Class B	±0.73°F at 70°F (±0.41°C at 21°C), DIN Class B
	100 ohm Platinum Averaging	±1.0°F at 70°F (±0.56°C at 21°C)
	1k ohm Platinum Averaging	
	2.2k ohm Thermistor	±0.36°F (±0.2°C) in the range: 32 to 158°F (0 to 70°C)
10k ohm Thermistor	±0.9°F (±0.5°C) in the range: 32 to 158°F (0 to 70°C)	
Sensor Temperature Coefficient	1k ohm Nickel	Approximately 3 ohms/°F (5.4 ohms/°C)
	1k ohm Nickel Averaging	
	1k ohm Platinum	Approximately 2 ohms/°F (3.9 ohms/°C) 3850 ppm/K
	100 ohm Platinum Averaging	Approximately 0.2 ohms/°F (0.39 ohms/°C)
	1k ohm Platinum Averaging	Approximately 2 ohms/°F (3.9 ohms/°C)
	2.2k ohm Thermistor	Nonlinear, Negative Temperature Coefficient (NTC)
Electrical Connection	10k ohm Thermistor	Nonlinear NTC, Johnson Controls Type II
	TE-63xxM	22 AWG (0.6 mm diameter) x 6 in. (152 mm) long
	TE-63xxP	
	TE-63xxF	22 AWG (0.6 mm diameter) x 12 ft (3 m) braided-copper wires, low voltage insulation, half-stripped ends
	TE-63xxP Nickel Averaging	18 AWG (1.0 mm diameter) x 6 in. (152 mm) long
	TE-63xS	22 AWG (0.6 mm diameter) x 10 ft (3 m) long plenum-rated cable
TE-63xxA, TE-63xxV	22 AWG (0.6 mm diameter) x 10 ft (3 m) long plenum-rated cable with 0.25 in. (6.35 mm) female quick-connect terminals	

The performance specifications are nominal and conform to acceptable industry standards. For applications at conditions beyond these specifications, consult the local Johnson Controls office. Johnson Controls, Inc. shall not be liable for damages resulting from misapplication or misuse of its products. © 2013 Johnson Controls, Inc. www.johnsoncontrols.com



TE-6300 Series Temperature Sensors (Continued)

TE-6300 Series Temperature Sensors (Part 2 of 2)		
Materials	Probes	Nickel Averaging: 0.094 in. (2.4 mm) Outside Diameter (O.D.) copper tubing Nickel Averaging Adaptor: 0.25 in. (6.35 mm) O.D. Brass Platinum Averaging Probe: 0.19 in. (4.8 mm) Aluminum tubing All others (except Averaging): 0.25 in. (6.35 mm) O.D. Stainless Steel
	TE-63xxA	Mounting Adapter Plate and Gland: Thermoplastic
	TE-63xxF	Flush Mount: Stainless Steel
	TE-63xxM	Enclosure: Corrosion-Protected Steel Well Sensor Holder: 0.875 in. (22.2 mm) Hex Brass
	TE-63xxP	Conduit box and Shield: Rigid Thermoplastic Mounting Plate: Aluminum Sensor Holder: Rigid Thermoplastic Wall Mount Base Plate: Corrosion-Protected Steel Wall Mount Cover: Rigid Thermoplastic (White) Wall Mount Face Plate: Brushed Aluminum
	TE-63xxV	Mounting Flange: Stainless Steel
	Operating Conditions	TE-63xxA
TE-63xxF		32 to 104°F (0 to 40°C)
TE-63xxM		-50 to 220°F (-46 to 104°C)
TE-63xxP		Enclosure: -50 to 122°F (-46 to 50°C) Sensor Probe: -50 to 220°F (-46 to 104°C)
TE-63xS		Sensor Probe: -50 to 220°F (-46 to 104°C)
TE-63xxV		Wire Harness: -50 to 122°F (-46 to 50°C)
Shipping Weight	TE-63xxA	0.2 lb (0.09 kg)
	TE-63xxF	0.25 lb (113.4 kg)
	TE-63xxM	Duct Averaging: 0.9 lb (0.41 kg) Duct Mount: 0.4 lb (0.18 kg) Well Insertion: 0.5 lb (0.23 kg)
	TE-63xxP	Duct Averaging: 0.5 lb (0.23 kg) Duct Mount: 0.4 lb (0.18 kg) Outdoor Air: 0.5 lb (0.23 kg) Wall Mount: 0.2 lb (0.09 kg) Well Insertion: 0.35 lb (0.16 kg)
	TE-63xS	Strap-Mount: 0.2 lb (0.09 kg)
	TE-63xxV	Duct Averaging: 0.7 lb (0.32 kg) Duct Mount: 0.2 lb (0.09 kg)
	Dimensions (H x W x D)	TE-63xxA
TE-63xxF		Flush Mount: 4-1/2 x 2-3/4 in. (114 x 70 mm)
TE-63xxM		Duct Averaging: 1.87 x 1.87 x 1.80 in. (47.5 x 47.5 x 45.8 mm) plus 8 or 17 ft (2.4 or 5.2 m) element Duct Mount: 1.87 x 1.87 x 1.80 in. (47.5 x 47.5 x 45.8 mm) plus 4, 8, or 18 in. (102, 203, or 457 mm) element Well Insertion: 1.87 x 1.87 x 1.80 in. (47.5 x 47.5 x 45.8 mm) plus 6 or 8 in. (152 or 203 mm) element
TE-63xxP		Duct Averaging: 5.97 x 1.38 x 2.75 in. (152 x 35 x 70 mm) plus 8, 10, 17, or 20 ft (2.4, 3.0, 5.2, or 6.1 m) element Duct Mount: 5.97 x 1.38 x 2.75 in. (152 x 35 x 70 mm) plus 6 or 8 in. (152 or 203 mm) probe Outdoor Air: 5.97 x 3.47 x 4.46 in. (152 x 88 x 113 mm) Wall Mount: 2.09 x 3.12 x 1.80 in. (53 x 79 x 46 mm) Well Insertion: 5.97 x 1.38 x 2.75 in. (152 x 35 x 70 mm) plus 6 or 8 in. (152 or 203 mm) probe
TE-63xS		Strap-Mount: 0.25 in. (6.35 mm) diameter x 3.00 in. (76 mm.) long
TE-63xxV		Duct Averaging: 2.25 x 1.50 in. (57 x 38 mm) plus 8 or 17 ft (2.4 or 5.2 m) element Duct Mount: 2.25 x 1.50 in. (57 x 38 mm) plus 4 or 8 in. (102 or 203 mm) element

The performance specifications are nominal and conform to acceptable industry standards. For applications at conditions beyond these specifications, consult the local Johnson Controls office. Johnson Controls, Inc. shall not be liable for damages resulting from misapplication or misuse of its products. © 2013 Johnson Controls, Inc. www.johnsoncontrols.com



Model 230

True Wet-to-Wet Differential Pressure Transducer

The Model 230 is Setra's highest accuracy solution for monitoring differential pressure in wet-to-wet applications. Its single diaphragm design enables a true wet-to-wet differential pressure measurement with superior $\pm 0.25\%$ FS accuracy compared to competitive units which calculate differential pressure using two single point pressure sensors. The stainless steel capacitive sensor provides a highly accurate, linear analog output proportional to the pressure over a wide temperature range. The 230 is offered with an optional 3 or 5 valve machined brass manifold for ease of installation and maintenance.

Avoid Line Pressure w/ Single Diaphragm Sensor

Unlike the competition, the 230 is a true wet-to-wet sensor with a single diaphragm construction. The differential pressure range of a single diaphragm is not impacted by line pressure whereas dual differential pressure sensors require the individual sensors to measure gauge pressure, comparing the outputs to determine the differential pressure.

Increase the Sensors Response Time

The 230 utilizes an all stainless steel capacitive sensor which responds 20x faster than oil filled sensors and provides conditioned electronic circuitry with a highly accurate, linear analog output proportional to the pressure over a wide temperature range.

Save Time on Money & Installation

When time and project costs are a priority, the 230 is offered with an optional 3 or 5 valve machined brass manifold for ease of installation and maintenance. The brass body has no internal process connections, therefore eliminating the risk of internal leaks.



- Single Diaphragm Design
- All Stainless Steel Capacitive Sensor
- 3 or 5 Valve Manifold Assembly Options

Model 230 Features:

- $\pm 0.25\%$ FS Accuracy 
- No Liquid Fill Diaphragm
- NEMA 4 Rated Housing
- Low Line Pressure Effect
- Fast Response Time
- Gas & Liquid Compatible
- Meets CE Conformance Standards

Applications:

- Energy Management Systems
- Process Control Systems
- Flow Measurement of Various Gases or Liquids
- Liquid Level Measurement or Pressurized Vessels
- Pressure Drop Across Filters

Model 230

True Wet-to-Wet Differential Pressure Transducer



PROOF PRESSURE

Unidirectional		
Pressure Range PSID	Proof Pressure High Side PSI	Proof Pressure Low Side PSI
0 to 1.0	50	2.5
0 to 2.0	50	5
0 to 5.0	100	12.5
0 to 10.0	100	25
0 to 25.0	350	62.5
0 to 30.0	350	75
0 to 50.0	350	125
0 to 100.0	350	250

Bidirectional		
Pressure Range PSID	Proof Pressure High Side PSI	Proof Pressure Low Side PSI
0 to ±0.5	50	1.25
0 to ±1.0	50	2.5
0 to ±2.5	100	6.35
0 to ±5.0	100	12.5
0 to ±10.0	200	25
0 to ±25.0	350	62.5
0 to ±50.0	350	125

GENERAL SPECIFICATIONS

Performance Data		Physical Description (Model 230)	
Accuracy RSS ¹ (at constant temp)	±0.25% FS	Case	Stainless Steel/Aluminum
Non-Linearity, BFSL	±0.20% FS	Electrical Connection	Bar/br strip terminal block with conduit enclosure & 0.875 DIA conduit opening.
Hysteresis	0.10% FS	Pressure Fittings	1/4"-18 NPT Internal
Non-Repeatability	0.05% FS	Weight (approx.)	14.4 oz
Thermal Effects²		Sensor Cavity Volume	0.27 in ³ Positive Port, 0.08 in ³ Negative Port
Compensated Range °F(°C)	+30 to +150 (-1 to +65)	(With 1/4"NPT external fittings installed does not include cavity volume of 1/4"NPT external fittings.)	
Zero Shift 96FS/100°F(96FS/50°C)	2.0 (1.8)	Physical Description (3-Valve Manifold Assembly)⁴	
Span Shift 96FS/100°F(96FS/50°C)	2.0 (1.8)	Manifold Block	Brass
Line Pressure Effect	Zero shift ±0.004% FS/PSIG line pressure	Valves (3) ⁵	V1 for Connection to + port V2 for Connection to - port V3 for Equalizing Pressure
Resolution	Infinite, limited only by output noise level (0.0284FS)	Valve Type	90° On/Off
Static Acceleration Effect	2861 S/g (most sensitive axis)	Process Connections	1/4"-18 NPT Internal Thread
Natural Frequency	500 Hz (gaseous media)	Dimensions	7.05"W x 6.25"H x 2.16"D
Warm-up Shift	±0.17% FS total ⁶	Weight	<2.5 lbs.
Response Time	30 to 50 milliseconds	Physical Description (5-Valve Manifold Assembly)⁴	
Long Term Stability	0.5815/1 YR	Manifold Block	Brass
Maximum Line Pressure	350 PSIG	Valve (5) ⁵	V1 for Connection to ± Port V2 for Connection to - Port V3 for Equalizing Pressure V4 & V5 for Connection to External Gauge or Alternate Plumbing Configuration
Environmental Data		Process Connection	1/4"-18 NPT Internal Thread
Operating Temperature °F (°C)	0 to +175 (-18 to +80)	Dimensions	7.05"W x 6.25"H x 2.16"D
Storage Temperature °F (°C)	-65 to +250 (-54 to +121)	Weight	<3.8 lbs.
Vibration	5 g from 5 Hz to 500 Hz	Electrical Data (Voltage)	
Acceleration	10g	Circuit	3-Wire (Exc, Out, Com)
Shock	50g	Excitation	9 to 30 VDC for 0-5 VDC Output, 13 to 30 VDC for 0-10 VDC Output
Pressure Media		Output ⁷	0 to 5 VDC ⁸ , 0 to 10 VDC ⁹
Model 230		Output Impedance	100 ohms
Gases or liquids compatible with 17-4 PH Stainless Steel, 300 Series Viton O-Rings. Note: Hydrogen not recommended for use with 17-4 PH stainless steel. Optimal Buna-N O-Rings are recommended for hydrocarbon applications.		Electrical Data (Current)	
3 & 5 Valve Manifold		Circuit	2-Wire
Gases or liquids compatible with 360 brass, Copper 122, Acetal plug valves and Viton O-Rings.		Output ⁷	4 to 20mA ¹⁰
		External Load	0 to 1000 ohms
		Minimum supply voltage (VDC)	9 + 0.02 x (Resistance of receiver plus line).
		Maximum supply voltage (VDC)	30 + 0.004 x (Resistance of receiver plus line).

¹ RSS of Non-Linearity, Hysteresis, and Non-Repeatability
² Units calculated at nominal 70°F. Maximum thermal error computed from this datum.
³ Operating temperature limits of the electronics only. Pressure media temperatures may be considerably higher.
⁴ Order assembled with the Model 230 (Code 30) or separately as Option 891.
⁵ Refer to drawing.
⁶ Order assembled with the Model 230 (Code 5V).
⁷ Calibrated into a 56k ohm load, operable into a 500 ohm load or greater.
⁸ Zero output factory set to within ±25mV (for 5VDC output) or ±50mV (for 10VDC output).
⁹ Span (Full Scale) output factory set to ±25 mV (for 5 VDC output) or ±50 mV (for 10 VDC output).
¹⁰ Calibrated at factory with a 24 VDC loop supply voltage and a 250 ohm load.
¹¹ Zero output factory set to within ±0.16mA. Span factory set to within ±0.16 mA.

Model 230

Wet-to-Wet Differential Pressure Transducer



MODEL 230 DIMENSIONS

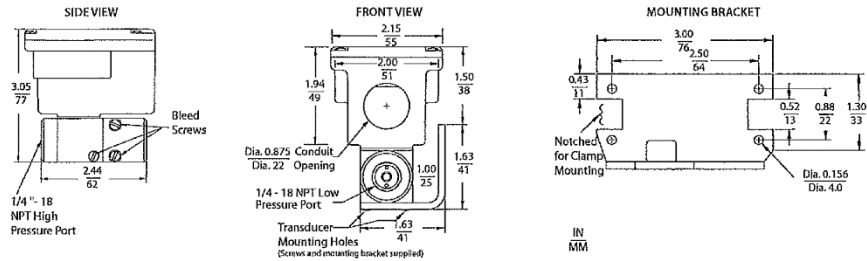

DIMENSIONS W/ 3-VALVE MANIFOLD ASSEMBLY

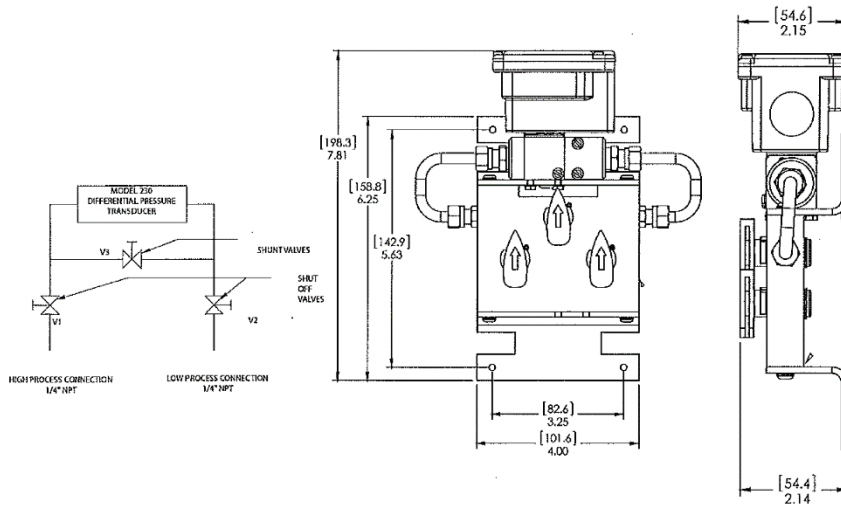

For differential pressure measurements at high line pressure (350 PSIG max), it is recommended that the pressure sensor be installed with a valve in each line, plus a shunt valve across the high and low (reference) pressure ports as shown.

Model 230

True Wet-to-Wet Differential Pressure Transducer



ORDERING INFORMATION

Model	Range		Pressure Fitting		Output	Bleed Screw Seals		Optional
2301 = 230	Unidirectional	Bidirectional	2E	1/4" NPT (F)	11	4-20 mA	Std.	B Viton
	001PD 0 to 1 PSID	0R5PB ±0.5 PSID	3V	3-Valve Manifold	2D	0.05-5.05 VDC	Opt.	A Buna-N
	002PD 0 to 2 PSID	001PB ±1 PSID	5V	5-Valve Manifold	2E	0.05-10.05 VDC		C Calibration Certificate
	005PD 0 to 5 PSID	2R5PB ±2.5 PSID						
	010PD 0 to 10 PSID	005PB ±5 PSID						
	025PD 0 to 25 PSID	010PB ±10 PSID						
	030PD 0 to 30 PSID	025PB ±25 PSID						
	050PD 0 to 50 PSID	050PB ±50 PSID						
	100PD 0 to 100 PSID							

Please contact factory for versions not shown.

Ordering Example: 2301005PD2F11B = Model 230 0 to 5 PSID unidirectional, 1/4-18 NPT Male fitting, 4 to 20 mA Output, and Viton/Silicone Seals.
 2301005PD3V11B = Model 230, 0 to 5 PSID unidirectional, 3-Valve Manifold, 4 to 20 mA, Output, and Viton/Silicone Seals (Assembled w/3- Valve Manifold).

DIMENSIONS W/ 5-VALVE MANIFOLD ASSEMBLY

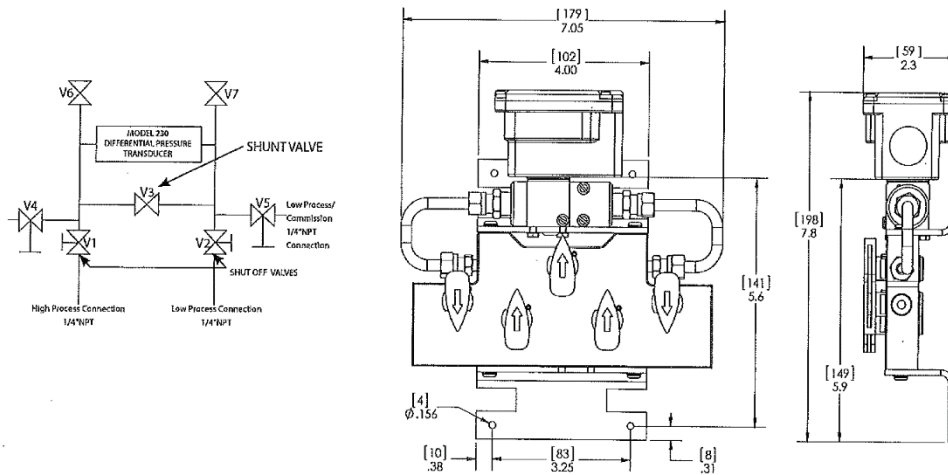

For differential pressure measurements at high line pressure (350 PSIG max), it is recommended that the pressure sensor be installed with a valve in each line, plus a shunt valve across the high and low (reference) pressure ports as shown.
 Note: V6 and V7 bleed valves are not required when used with a Setra Model 230. Use the bleed screws on Model 230 to bleed the lines of air.

C. Correspondence Regarding the Correct Sizing of the MBC Chiller

As discussed in the Preface section titled “MBC Chiller Cooling Capacity,” after the initial report was published, Danfoss Turbocor Compressors (Danfoss) informed the project team that the MBC chiller evaluated at the Yates was oversized for the required 275 tons cooling capacity. They asserted that it was, in fact, a 400-ton chiller.

To determine if this was, in fact, the case. And if so, to determine how this might have come to pass, the project team conducted a thorough investigation of events that led up to this chiller’s selection. Details of this investigation are in the following paragraphs, and in the pages of e-mail images contained within this appendix.

In 2014, Setty & Associates (Setty) calculated the cooling capacity requirements for each chiller to be 275 tons. The pages captured below in this appendix show a 2014 e-mail chain between Tatyana Shine (project manager), Michael Rakes (Senior Engineer with Setty), and Thor Fraser (Sales Engineer for Havtech, the local Daikin representative). In their correspondence, it is very clear that the requested cooling capacity is 275 tons. Mr. Fraser verifies this in writing, and provides performance details of a Daikin WMC400 chiller that he stated meets this specification.

In October 2014, GSA asked Dan Howett of Oak Ridge National Laboratory (Principal Investigator on this project) to review the submittals from Daikin and Carrier. Each submittal showed that the proposed chillers were rated for 275 tons of cooling capacity, had the same condenser water flow rates and temperature drops, and the same evaporator flow rates and temperature drops. Their Integrated Part Load Values (IPLVs) were both in the range of .328 - .332kw/ton, within 1.2% of each other. In short, there was no reason to suspect that both units were other than 275 ton chillers.

Later in the project, Dan Howett noted that the submittal from Daikin called for a “WMC400” chiller, which Daikin’s literature listed as being the frame for units with nominal 300–400 ton cooling capacities. He reached out to Havtech to clarify the apparent discrepancy and received the following response from Mr. Dick Shafer of Havtech.

“There are thousands of selections by computers these days as opposed to years ago where the selections were in the catalog and that is what you get. Still true of water-cooled and air-cooled scroll chillers.

“You have 400 ton shells in the evaporator and condenser and less than 275 tons in compressors. Chillers were selected for the most efficient.”

Again, the project team had no reason to believe that the Daikin chiller provided by Havtech was anything but a chiller that was optimized to provide 275 tons of cooling under the conditions specified by Setty.

As part of the evaluation team’s post-publishing investigation of the installed MBC equipment, GSA documented that the Daikin WMC400 chiller was equipped with two TT500 compressors. According to information provided by Danfoss in May of 2017, their TT500 compressor has a nominal 200 ton cooling capacity. Therefore, it can be reasonably concluded that the Daikin chiller provided by Havtech at the Yates test bed can, in fact, provide 400 tons of cooling capacity, even though the performance specification called for only 275 tons and the vendor’s engineer repeatedly affirmed, in writing, that this was the capacity supplied.

Kevin Powell, GPG Program Manager, reached back to Havtech in May 2017 for further clarification. The response provided by Havtech is printed verbatim and in its entirety below.

Kevin:

I was requested for an efficient 275 Ton selection ton back in 2014 at the tonnage and conditions noted by Setty & Associates. I remember the request as I did in within an hour with the lowest full load KW/Ton at 42 LWT design conditions. There was never further discussions regarding the application of the or the building load profile. If we selected a chiller optimized for the actual building profile and low load conditions, the selection could have been different than one driven by the full load. In this case the 42 LWT NPLV is better indicator of annual energy consumption than the full load KW/Ton machine.

Dick Shafer

After thoroughly reviewing all documents and correspondence on this issue, the evaluation team draws the following three conclusions.

- At no time throughout the entire process, up until spring 2017, did the project team have any reason to believe that they had received anything other than an optimized 275-ton Daikin chiller from Havtech. Due diligence was performed at every step to verify that an appropriate 275-ton MBC chiller was installed at the Yates test bed. The installed MBC chiller is therefore representative of a vendor-supplied chiller meeting engineering requirements for a 275-ton load delivered through a well-managed federal procurement process.
- The test bed design for GPG-031 was to use a chiller technology that GPG had previously proved out as delivering known state-of-the-art-performance (MBC) as a baseline to compare a second chiller technology (VSS) with similar or better performance claims. The MBC vendor confirmed that they believed they were providing the most efficient MBC chiller for the project at the Yates test bed. All documentation supports the installed MBC chiller as legitimately representative of what a typical engineering and procurement process would deliver for this application, and therefore a credible baseline.
- Retrospective speculation about what a different MBC chiller's performance "could have been" is outside the scope of this assessment.

(Screen captures of the referenced e-mail chain are on the pages that follow.)

Spencer Matusky

From: Tatyana Shine <tatyanashine@gmail.com>
Sent: Tuesday, October 07, 2014 4:31 PM
To: Spencer Matusky
Subject: Fwd: Yates Chiller Project
Attachments: WMC400DC-E3012-L2F-C2612-L2F_Chiller.20141007.205202.docx

FYI

----- Forwarded message -----

From: Thor Fraser <ThorFraser@havtech.com>
Date: Tue, Oct 7, 2014 at 3:55 PM
Subject: RE: Yates Chiller Project
To: Tatyana Shine <tatyanashine@gmail.com>

Hi Tatyana,

Attached is a picture of the WMC400 that Setty has worked up with us. I spoke with Larry Manross, who handles Flotron's account, and it sounds like this is the machine they quoted you to furnish/install.

The performances are:

Capacity: 275 Tons

Evaporator: 53.9F entering, 44F leaving,
Flow rate = 660 gpm,
Pressure drop = 10.8 ft wg

Condenser: 85F entering, 94.36F leaving,
Flow rate = 825 gpm,
Pressure drop = 7.3 ft wg

Electrical: Chiller Input Voltage = 460V
Chiller RLA = 204 amps
MCA = 230 amps

MOCP = 300 amps

Thor Fraser

Sales Engineer

HAVTECH

9505 Berger Road

Columbia, MD 21046

Baltimore: [410-724-3703](tel:410-724-3703)

Washington: [301-206-9225](tel:301-206-9225)

Direct: [443-832-1671](tel:443-832-1671)

Mobile: [301-787-5689](tel:301-787-5689)

ThorFraser@havtech.com

www.HAVTECH.com

From: Tatyana Shine [<mailto:tatyanashine@gmail.com>]

Sent: Monday, October 06, 2014 2:32 PM

To: Thor Fraser

Subject: Fwd: Yates Chiller Project

Hi Thor,

Please see the Carrier chiller performance data, below. What Daikin's machine (250 or 290) performance will be closer to Carrier 275- ton machine performance?

Carrier's 275-ton chiller is under production now and it will cost additional money to change it to a larger or smaller tonnage, now.

Thanks,

Tatyana

----- Forwarded message -----

From: **Dwyer, Brian P BIS** <brian.dwyer@carrier.utc.com>

2

Date: Mon, Oct 6, 2014 at 1:59 PM
Subject: RE: Yates Chiller Project
To: Tatyana Shine <tatyanashine@gmail.com>

Tatyana...Performance data at ARI conditions for Carrier chiller noted below was sent to design team following our first site walk-through.

Let me know if you have any question.

Brian

Brian Dwyer, LEED AP

General Manager, Government Solutions

Carrier Corporation

1 Carrier Place

Farmington, CT 06034

brian.dwyer@carrier.utc.com

Phone [860.674.3157](tel:860.674.3157)

Cell [203.558.1312](tel:203.558.1312)

From: Dwyer, Brian P BIS
Sent: Friday, September 12, 2014 10:57 AM
To: 'Michael Rakes'
Cc: Tatyana Shine; Spencer, Michael BIS

Subject: RE: Yates Chiller Project

Michael,

Here's performance and electrical data for Carrier machine. Component dimensions and weights will follow.

We are furnishing chiller directly to GSA, so there is no quotation for chiller. Quotation for Carrier to provide disassemble/reassembly of machine will be provide to mechanical contractors.

Capacity: 275 Tons

Evaporator: 54F entering, 44F leaving,

Flow rate = 660 gpm,

Pressure drop = 13.9 ft wg

Condenser: 85F entering, 94.4F leaving,

Flow rate = 825 gpm,

Pressure drop = 12.4 ft wg

Electrical: Chiller Input Voltage = 460V

Chiller RLA = 252.2 amps

Chiller Inrush = 252.2 amps

MCA = 315 amps

MOCP = 500 amps

Recommended current protection: Not less than 400A, not more than 500A

Regards,

Brian

Brian Dwyer, LEED AP

General Manager, Government Solutions

Carrier Corporation
1 Carrier Place
Farmington, CT 06034

brian.dwyer@carrier.utc.com

Phone [860.674.3157](tel:860.674.3157)

Cell [203.558.1312](tel:203.558.1312)

From: Dwyer, Brian P BIS
Sent: Friday, September 12, 2014 8:25 AM
To: Michael Rakes; Spencer, Michael BIS
Subject: RE: Yates Chiller Project

Michael... We are collecting this information and expect to have it to you later today.

Regards,

Brian

Brian Dwyer, LEED AP

General Manager, Government Solutions

Carrier Corporation

1 Carrier Place

Farmington, CT 06034

brian.dwyer@carrier.utc.com

Phone [860.674.3157](tel:860.674.3157)

Cell [203.558.1312](tel:203.558.1312)

From: Michael Rakes [<mailto:Michael.Rakes@setty.com>]
Sent: Wednesday, September 10, 2014 4:26 PM
To: Spencer, Michael BIS; Dwyer, Brian P BIS
Subject: [External] Yates Chiller Project

Gentlemen –

Please provide cut sheets that include weight, all performance characteristics including electrical information. Additionally, please provide pricing for chiller and an estimate of installed cost including breakdown and reassembly.

Thank you,

Michael Rakes, P.E., LEED^{AP}, HBDP | Sr Mechanical Engineer

SETTY

| Fairfax, VA | New York, NY | Washington, DC | Mysore, India

| M/E/P/FP Design Engineering | Project Management | Construction Management | Design-Build Services | Commissioning

| Voice [703.691.2115](tel:703.691.2115) x142 | Fax [703.691.8084](tel:703.691.8084) | Cell [703.314.1509](tel:703.314.1509) | michael.rakes@setty.com | www.setty.com

This e-mail and any files transmitted with it are confidential and are intended solely for the use of the individual or entity to whom they are addressed. If you are NOT the intended recipient or the person responsible for delivering the e-mail to the intended recipient, be advised that you have received this e-mail in error and that any use, dissemination, forwarding, printing or copying this e-mail is strictly prohibited.

D. References

The following publications were used as references for this evaluation.

S. A. Parker and J. Blanchard of Pacific Northwest National Laboratory (December 2013), *Variable-Speed Oil-free Centrifugal Chiller with Magnetic Bearings Assessment: George Howard, Jr. Federal Building and U.S. Courthouse, Pine Bluff, Arkansas*. Available at <https://www.gsa.gov/portal/content/180775>.

U.S. Department of Energy, Federal Energy Management Program (November 2015), "M&V Guidelines: Measurement and Verification for Performance-Based Contracts," Version 4.0. Available at https://energy.gov/sites/prod/files/2016/01/f28/mv_guide_4_0.pdf.

U.S. Environmental Protection Agency (February 2014), "eGRID 9th edition Version 1.0, Year 2010 Summary Tables." Available at https://www.epa.gov/sites/production/files/2015-01/documents/egrid_9th_edition_v1-0_year_2010_summary_tables.pdf.