

# LED LIGHTING AND CONTROLS GUIDANCE

FOR FEDERAL BUILDINGS



## Disclaimer

This document was prepared as an account of work sponsored by the United States Government. While this document is believed to contain correct information, neither the United States Government nor any agency thereof, Pacific Northwest National Laboratory (PNNL), nor any of their employees, makes any warranty, express or implied, or assumes any legal responsibility for the accuracy, completeness, or usefulness of any information, apparatus, product, or process disclosed, or represents that its use would not infringe privately owned rights. Reference herein to any specific commercial product, process, or service by its trade name, trademark, manufacturer, or otherwise, does not constitute or imply its endorsement, recommendation, or favoring by the United States Government or any agency thereof, or PNNL. The views and opinions of the authors expressed herein do not necessarily state or reflect those of the United States Government or any agency thereof or PNNL.

## Acknowledgments

**Pacific Northwest National Laboratory:** Michael Myer, Linda Sandahl, Jessica Collier, Isaiah Steinke

**GSA Green Proving Ground:** Kevin Powell, Tyler Harris

**GSA:** Corey Blatt, Michael Bloom, Jeff Domber, Susan Minson, Mark Nyquist, Jeff Schetrompf, Bryan Steverson, Martin Weiland

**DOE:** Wyatt Merrill, Bryan Howard, Dylan Jones, Creshona Armwood, Allison Ackerman, Nael Nmair, Sarah Butler, Laura Zuber

**Tenfold Information Design Services:** Andrea Silvestri, Donna Creason, Carolyn St. Jean, Bill Freais

This work was authored by the Pacific Northwest National Laboratory, operated by Battelle, for the U.S. Department of Energy (DOE) under Contract No. DE-AC05-76RL01830. Funding was provided by GSA under Agreement 47PA0119A0008. The U.S. Government retains, and the publisher, by accepting the work for publication, acknowledges that the U.S. Government retains, a nonexclusive, paid-up, irrevocable, worldwide license to publish or reproduce the published form of this work, or allow others to do so, for U.S. Government purposes.

PNNL document # PNNL-SA\_181443

# Contents

## Executive Summary

Overview . . . . .	4
Decision Flowcharts for Linear Lighting & Controls . . . . .	5
Financial Inputs for Lighting Decisions . . . . .	6
Life-Cycle Cost Effectiveness . . . . .	8

## LED Lighting

LED System Features . . . . .	12
Interior LED Retrofit Options . . . . .	16
Type A TLED . . . . .	17
Type B TLED . . . . .	18
Type C TLED . . . . .	19
Troffer Retrofit Kits . . . . .	20
New Troffer and Linear Luminaires . . . . .	21
PoE Lighting . . . . .	22
Other Interior Lighting . . . . .	23
Emergency and Egress Lighting . . . . .	24
Exterior Lighting . . . . .	26

## Lighting Controls

### Steps for Designing a Lighting Control System . . . . .

<b>1</b> Review Energy Code Requirements . . . . .	30
<b>2</b> Assess Need for Enhanced Capabilities . . . . .	31
<b>3</b> Design Lighting Zone . . . . .	32
<b>4</b> Select a System Architecture . . . . .	33
<b>5</b> Determine Sensor and Controller Locations . . . . .	38
<b>6</b> Configure Control Wiring . . . . .	41
<b>7</b> Identify Communication Protocols . . . . .	43
<b>8</b> Plan for Retro- and Re-Commissioning . . . . .	45

### Energy-Saving Capabilities . . . . .

Combining Lighting Savings . . . . .	47
Scheduling . . . . .	48
Occupancy Sensing . . . . .	49
Dimming . . . . .	51
Daylight-Responsive Control . . . . .	52
Task Tuning . . . . .	53
HVAC Integration . . . . .	54
Demand Response . . . . .	55

### Enhanced Performance Capabilities . . . . .

## Appendix

List of Figures and Tables . . . . .	58
References . . . . .	59

# Overview

Use this guide as a roadmap and reference to select the best lighting system for your facility.

In support of the Bulb Replacement Improving Government with High-Efficiency Technology Act, Pub. L. No. 117-202 (October 17, 2022) (BRIGHT Act), this document provides general guidance to federal agencies on procuring and using the most life-cycle cost-effective and energy-efficient lighting systems/technology currently available. Many factors, such as site conditions, design, maintenance, and lighting usage, influence a project's overall life-cycle cost effectiveness. As a result, each project will yield a different return on investment (ROI).

The guide offers best practices and outlines different types of light-emitting diode (LED) fixtures and control options, how they can benefit buildings and occupants, and where they are best suited. If designed correctly, new lighting installations, replacements, and retrofits can provide intrinsic benefits to occupants' health, sense of place, and comfort. During system selection, begin with code requirements. For example, *GSA's Facility Standards for the Public Buildings Service (PBS-P100)* requires all U.S. General Services Administration (GSA) projects to meet *ASHRAE/IES Standard 90.1*.

LED Lighting covers the different types of LED installations, including tubular LEDs (TLEDs), retrofit kits, and new fixtures. This section focuses on interior linear lighting because such systems represent the majority of lighting within the federal real estate portfolio.

Lighting Controls discusses the decisions that need to be made when selecting a control system that complies with applicable code, GSA requirements, project objectives, energy savings, and enhanced performance capabilities.

This guidance also presents lessons learned from evaluations conducted by GSA's Green Proving Ground (GPG) and other real-world federal building deployments.



The BRIGHT Act directs federal agencies to procure the most life-cycle cost-effective and energy-efficient lighting systems currently available.

Use these decision flowcharts to help determine which technologies and systems will be most cost effective for retrofitting your linear fixture lighting.

**Figure 1**  
Decision Flowchart for Lighting Controls

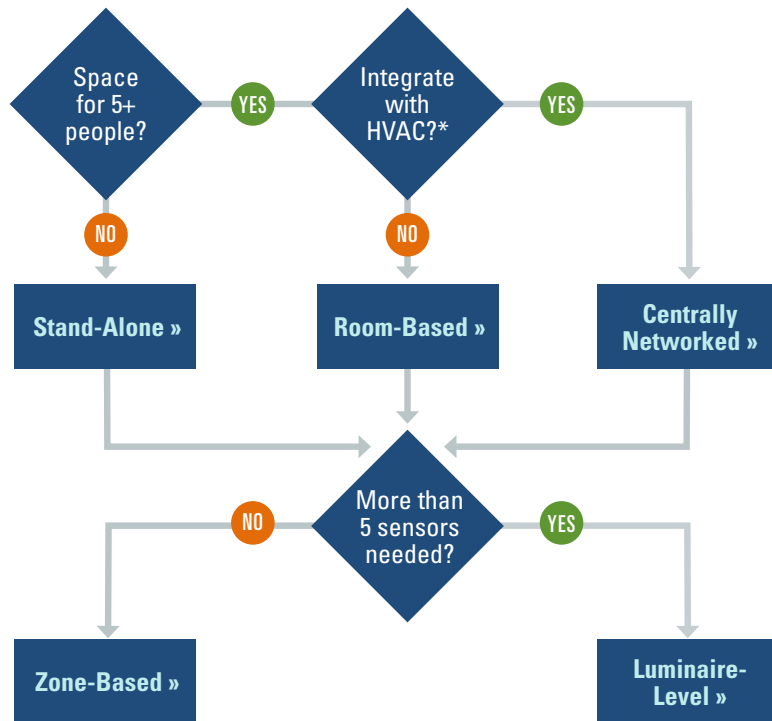

\*Heating, ventilation, and air conditioning (HVAC) integration is recommended for buildings over 50k ft<sup>2</sup>; consider for buildings over 25k ft<sup>2</sup>

**Figure 2**  
Decision Flowchart for Retrofitting Linear LED Lighting

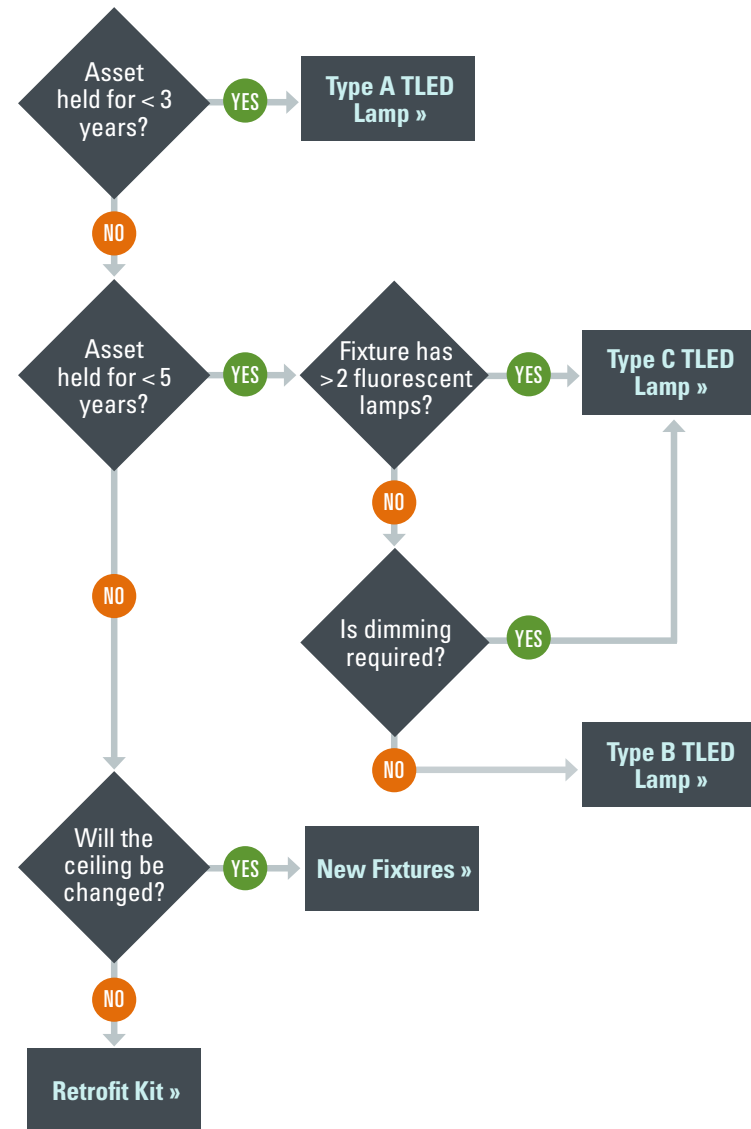

# Financial Inputs for Lighting Decisions

There are many factors that influence the overall cost effectiveness of a project, and each project will yield a different return on investment (ROI). Consider the following when evaluating the financial returns on a lighting project.

## Buy American Act

The Buy American Act (BAA) requires federal agencies to procure products that are at least 50% produced in the U.S. Most LED chips are manufactured overseas, so BAA-compliant products need to be assembled here. If the U.S. has a trade agreement with another country, a product assembled in that country also meets the BAA requirement. BAA can sometimes limit options, and lower-cost products are not necessarily the best choice. Look for good quality products and manufacturer track records. Many vendors enable internet searching by BAA status.

## Demand Charges

Demand charges and other grid-related operational costs continue to rise and, in some locations, can exceed actual energy costs.

## Federal Building Performance Standard

In December 2022, the Biden-Harris Administration established the first [Federal Building Performance Standard](#). This standard requires agencies to cut energy use in 30% of the building space owned by the Federal Government by 2030. Implementing LED and controls will assist in meeting this requirement.

## First Costs

Some lighting options might have a lower first cost but a greater life-cycle cost compared to other options. Most lighting equipment (fixtures, controls, and sensors) will have at least a 15-year life cycle, and per BRIGHT Act requirements, this period of performance should be used.

## Heating Interactions

The heat generated by most older lighting technology affects the ambient temperature and, therefore, the heating, ventilation, and air conditioning (HVAC) system. Consider cooling savings, particularly in hot climates, when converting to LED lighting. In a deep retrofit, if lighting is part of the process, consider downsizing the HVAC system.

## Maintenance, Controls

Controls, for the most part, should not have ongoing maintenance costs, but they will need to be reprogrammed as space changes and may need periodic system updates.

## Maintenance, Exterior LED

Exterior lighting operation and maintenance (O&M) costs are often significantly higher than those associated with interior lighting because exterior lighting is replaced more frequently and because replacing it can require special equipment. In some cases, the cost of servicing parking lot lighting using bucket trucks can exceed the cost of the lighting. The maintenance savings from an exterior LED lighting installation should be factored into new and existing GSA O&M contracts.

## Maintenance, Interior LED

Since LEDs last about twice as long as fluorescent lamps, a conversion to LEDs will result in less maintenance. GSA's GPG technology evaluations ([GPG-024, LED Fixtures with Integrated Advanced Lighting Controls](#)) at the Ralph H. Metcalfe Federal Building in Chicago, IL, and the Peachtree Summit Federal Building in Atlanta, GA, found that 25% of the cost savings from converting fluorescent to LED lights was due to reduced maintenance. Over a 15-year period, the cumulative present value of avoided maintenance costs was over \$1.00/ft<sup>2</sup>. In contrast, during this same period, the cumulative present value of avoided energy cost was about \$3.50/ft<sup>2</sup>. Renegotiating your O&M contract may result in significant savings.

# Financial Inputs for Lighting Decisions

## Performance Contracts

Energy savings performance contracts (ESPCs) come with a price premium and have longer simple paybacks than directly funded projects. In an ESPC, energy savings are guaranteed for a number of years into the future. Roughly one-third of GSA projects use ESPC financing.

## Rebates

You can find rebate opportunities at [DSIRE](#), [ENERGY STAR Rebates for Commercial Buildings](#), or [BriteSwitch](#). In a 2022 analysis, 77% of U.S. utilities offered lighting rebates.

Rebates for networked lighting controls increased by 16% in 2022. Rebates for non-networked lighting controls have been relatively stable since 2008.

## Utility Areawide Contracts

GSA establishes long-term government-wide contracts with regulated public utility companies. These areawide contracts (AWCs) can be used to install LED lighting and controls through an energy management services agreement task order. The benefits of using an AWC for energy efficiency work include streamlined acquisition and better access to utility rebates and incentives.

## Warranty

Because GSA holds on to its buildings, and most LED devices have a 15-year or longer lifespan, look for 10-year warranties on kits, luminaires, and control systems. Check that the warranty period is not longer than the age of the company.

**Table 1**  
Average LED and Lighting Control Rebates in North America\*

Type of LED Solution	Avg. Rebate 2023
Replacement lamps (A19, PAR, MR)	\$8
TLEDs	\$4
Pin-based (CFL replacement)	\$6
Downlights	\$28
Troffer luminaires	\$33
Troffer retrofit kits (1x4, 2x2, 2x4)	\$34
Accent/track lighting	\$50
Screw-in high-intensity discharge (HID) retrofit	\$58
Outdoor wall mount	\$98
Parking garage	\$101
Outdoor pole	\$106
High bay fixtures	\$127

Type of Lighting Control	Avg. Rebate 2023
Remote-mounted occupancy sensors	\$26
Wallbox occupancy sensors	\$23
Photocells	\$20
Luminaire-mounted occupancy sensors	\$22
Daylight dimming systems	\$27

\*LED rebates: *BriteSwitch RebatePro for Lighting February 2023*  
Lighting control rebates: *Lighting Controls Association, 2023 Rebate Outlook*

**Table 2**  
5,000 ft<sup>2</sup> Life-Cycle Cost (LCC) Effectiveness for Linear LED Lighting Systems and Controls

TLEDs	SYSTEM LIFE (yrs)	ENERGY SAVINGS (%)	ENERGY SAVINGS (/ft <sup>2</sup> )	ENERGY SAVINGS (\$ / ft <sup>2</sup> )	FIRST COST (\$ / ft <sup>2</sup> )	PAYBACK (yrs)	LCC 15-YEAR*
TLED-A uses existing fluorescent ballast	4	35%	1.01 kWh 3.44 kBtu	\$0.11	\$0.20	1.8	\$19,679
<ul style="list-style-type: none"> <li>• Not recommended because of fluorescent ballast life expectancy. Replacement ballasts will be difficult to find in the future.</li> <li>• Less efficient than TLED-B and -C because of the conversion losses of the ballast.</li> <li>• Type A TLED and fluorescent ballast matching is difficult and makes this technology a challenge.</li> </ul>							
TLED-B bypasses ballast with direct wiring	8	35%	1.01 kWh 3.44 kBtu	\$0.11	\$0.28	2.5	\$17,903
<ul style="list-style-type: none"> <li>• 0-10V communication protocol possible from some manufacturers. May require additional wiring.</li> <li>• May require replacement of sockets ("tombstones").</li> <li>• Requires proper labeling to protect from fire hazards.</li> </ul>							
TLED-C incorporates new LED driver	10	35%	1.01 kWh 3.44 kBtu	\$0.11	\$0.28	2.5	\$17,270
<ul style="list-style-type: none"> <li>• 0-10V dimming possible from some manufacturers. May require additional wiring.</li> <li>• Ideal for multi-lamp fixtures; best for 4+ lamp fixtures.</li> <li>• May require replacement of sockets ("tombstones").</li> </ul>							
TLED-C with zone-based controls	10	59%	1.42 kWh 4.85 kBtu	\$0.16	\$0.34	2.2	\$14,022
<ul style="list-style-type: none"> <li>• When possible, combine equipment retrofit with lighting controls.</li> <li>• Other considerations for Type C TLED, occupancy sensors, and/or daylight sensors.</li> <li>• Type C TLED's use of an external driver may allow for easier incorporation of lighting controls compared to other TLED options.</li> </ul>							

\*LCC Assumptions: scaled to a 5,000 ft<sup>2</sup> building; baseline 3 lamp 32 W fluorescent fixture; 2900 operating hours; electricity rate \$0.11/kWh

Stand-Alone Control	SYSTEM LIFE (yrs)	ENERGY SAVINGS (%)	ENERGY SAVINGS (/ft <sup>2</sup> )	ENERGY SAVINGS (\$ / ft <sup>2</sup> )	FIRST COST (\$ / ft <sup>2</sup> )	PAYBACK (yrs)	LCC 15-YEAR*
Stand-alone occupancy control	15	24%	0.69 kWh 2.36 kBtu	\$0.07	\$0.03	0.4	\$17,450
<ul style="list-style-type: none"> <li>• Will require some additional wiring.</li> <li>• When possible, pair with other technology upgrades.</li> <li>• Proper sensor selection is important to prevent "false off," which affects user satisfaction.</li> </ul>							
Stand-alone daylight harvesting	15	28%	0.81 kWh 2.75 kBtu	\$0.08	\$0.04	0.5	\$16,594
<ul style="list-style-type: none"> <li>• If the existing fixture does not dim, replace it with a device that can dim first.</li> <li>• Will require some additional wiring.</li> </ul>							



**Table 2 (continued)**

**5,000 ft<sup>2</sup> Life-Cycle Cost (LCC) Effectiveness for Linear LED Lighting Systems and Controls**

Retrofit Kits	SYSTEM LIFE (yrs)	ENERGY SAVINGS (%)	ENERGY SAVINGS (/ft <sup>2</sup> )	ENERGY SAVINGS (\$ / ft <sup>2</sup> )	FIRST COST (\$ / ft <sup>2</sup> )	PAYBACK (yrs)	LCC 15-YEAR*
Retrofit kit with zone-based control	15	65%	1.87 kWh 6.38 kBtu	\$0.21	\$1.72	8.4	\$17,288
<ul style="list-style-type: none"> <li>Requires either low-voltage wires or wireless communication between the sensor and the luminaires.</li> <li>Ideal for low occupancy transitory spaces (e.g., restrooms, corridors, stairs, etc.).</li> <li>Spaces with many different fixture types and many custom or outlier fixture types may make finding retrofit kits difficult.</li> </ul>							
Retrofit kit with luminaire-level lighting control (LLLC), room-based	15	65%	1.87 kWh 6.38 kBtu	\$0.21	\$2.45	11.9	\$20,988
<ul style="list-style-type: none"> <li>Room-based controllers will be sized on both electrical capacity and number of zones—this will affect control design.</li> <li>Requires communication—either wired or wireless—between the controller, sensors, and luminaires.</li> <li>Spaces with many different fixture types and many custom or outlier fixture types may make finding retrofit kits difficult.</li> </ul>							
Retrofit kit with LLLC, centrally networked	15	70%	2.03 kWh 6.92 kBtu	\$0.22	\$4.21	18.9	\$28,679
<ul style="list-style-type: none"> <li>Economies of scale play a role; technology is more cost effective as the building size increases.</li> <li>Allows for more lighting control strategies than other options.</li> <li>If a digital system is selected, diagnostics or other information can be queried from the system.</li> </ul>							
Retrofit kit with LLLC, centrally networked with HVAC integration	15	70% lighting 20% HVAC	4.03 kWh 13.74 kBtu	\$0.44	\$4.93	11.1	\$23,189
<ul style="list-style-type: none"> <li>Provides more total energy savings and a shorter cost recovery period than just a lighting control system.</li> <li>More cost effective with larger buildings.</li> <li>Energy codes are starting to require occupied setback; this option leverages the occupancy sensors in a lighting system for HVAC integration.</li> </ul>							

\*LCC Assumptions: scaled to a 5,000 ft<sup>2</sup> building; baseline 3 lamp 32W fluorescent fixture; 2900 operating hours; electricity rate \$0.11/kWh

New Fixtures**	SYSTEM LIFE (yrs)	ENERGY SAVINGS (%)	ENERGY SAVINGS (/ft <sup>2</sup> )	ENERGY SAVINGS (\$ / ft <sup>2</sup> )	FIRST COST (\$ / ft <sup>2</sup> )	PAYBACK (yrs)	LCC 15-YEAR*
New fixture with zone-based controls	20	65%	1.87 kWh 6.38 kBtu	\$0.21	\$3.18	15.4	\$24,713
<ul style="list-style-type: none"> <li>New fixtures are optimized for LEDs and will control glare and provide optimal distribution.</li> <li>Requires either low-voltage wires or wireless communication between the sensor and the luminaires.</li> <li>Ideal for low occupancy transitory spaces (e.g., restrooms, corridors, stairs, etc.).</li> </ul>							
New fixture with LLLC control, room-based	20	65%	1.87 kWh 6.38 kBtu	\$0.21	\$3.90	19.0	\$28,413
<ul style="list-style-type: none"> <li>LLLC includes the sensor as part of the luminaire.</li> <li>Room-based controllers will be sized on both electrical capacity and number of zones—this will affect control design.</li> <li>Requires communication—either wired or wireless—between the controller, sensors, and luminaires.</li> </ul>							
New fixture with LLLC control, centrally networked	20	70%	2.03 kWh 6.92 kBtu	\$0.22	\$6.05	27.1	\$38,054
<ul style="list-style-type: none"> <li>Economies of scale play a role; technology is more cost effective as the building size increases.</li> <li>Allows for more lighting control strategies than other options.</li> <li>If a digital system is selected, diagnostics or other information can be queried from the system.</li> </ul>							
New fixture with networked controls + HVAC + IoT features	20	70% lighting 20% HVAC	4.03 kWh 13.74 kBtu	\$0.44	\$6.77	15.3	\$32,564
<ul style="list-style-type: none"> <li>Provides more total energy savings and a shorter cost recovery period than just a lighting control system.</li> <li>More cost effective with larger buildings.</li> <li>Energy codes are starting to require occupied setback; this option leverages the occupancy sensors in a lighting system for HVAC integration.</li> </ul>							

\*\* 20-year life expectancy of new fixtures exceeds 15-year LCC analysis

**Table 3**  
50,000 ft<sup>2</sup> Life-Cycle Cost Effectiveness for Controls

Retrofit Kits	SYSTEM LIFE (yrs)	ENERGY SAVINGS (%)	ENERGY SAVINGS (/ft <sup>2</sup> )	ENERGY SAVINGS (\$ / ft <sup>2</sup> )	FIRST COST (\$ / ft <sup>2</sup> )	PAYBACK (yrs)	LCC 15-YEAR*
Retrofit kit with zone-based control	15	65%	1.87 kWh 6.38 kBtu	\$0.21	\$1.67	8.1	\$170,182
<ul style="list-style-type: none"> <li>As building size increases, a retrofit may involve both a combination of mostly retrofit kits and some TLEDs.</li> <li>As size increases, retrofit installation becomes more efficient.</li> <li>Requires either low-voltage wires or wireless communication between the sensor and the luminaires.</li> <li>Ideal for low occupancy transitory spaces (e.g., restrooms, corridors, stairs, etc.).</li> <li>Spaces with many different fixture types and many custom or outlier fixture types may make finding retrofit kits difficult.</li> </ul>							
Retrofit kit with luminaire-level lighting control (LLLC), room-based	15	65%	1.87 kWh 6.38 kBtu	\$0.21	\$2.27	11.0	\$200,882
<ul style="list-style-type: none"> <li>Retrofit kits with integrated sensors are a common option.</li> <li>Room-based controllers will be sized on both electrical capacity and number of zones—this will affect control design.</li> <li>Requires communication—either wired or wireless—between the controller, sensors, and luminaires.</li> <li>Spaces with many different fixture types and many custom or outlier fixture types may make finding retrofit kits difficult.</li> </ul>							
Retrofit kit with LLLC, centrally networked	15	70%	2.03 kWh 6.92 kBtu	\$0.22	\$2.45	11.0	\$196,785
<ul style="list-style-type: none"> <li>Economies of scale play a role; technology is more cost effective as the building size increases.</li> <li>Recommended for facilities implementing a demand response strategy.</li> <li>Allows for more lighting control strategies than other options.</li> <li>If a digital system is selected, diagnostics or other information can queried from the system.</li> </ul>							
Retrofit kit with LLLC, centrally networked with HVAC integration	15	70% lighting 20% HVAC	4.03 kWh 13.74 kBtu	\$0.44	\$2.82	6.4	\$123,889
<ul style="list-style-type: none"> <li>Provides more total energy savings and a shorter cost recovery period than just a lighting control system.</li> <li>Cost per square foot of integration decreases in large buildings.</li> <li>Energy codes are starting to require occupied setback; this option leverages the occupancy sensors in a lighting system for HVAC integration.</li> </ul>							

\*LCC Assumptions: scaled to a 50,000 ft<sup>2</sup> building; baseline 3 lamp 32 W fluorescent fixture; 2900 operating hours; electricity rate \$0.11/kWh

New Fixtures**	SYSTEM LIFE (yrs)	ENERGY SAVINGS (%)	ENERGY SAVINGS (/ft <sup>2</sup> )	ENERGY SAVINGS (\$ / ft <sup>2</sup> )	FIRST COST (\$ / ft <sup>2</sup> )	PAYBACK (yrs)	LCC 15-YEAR*
New fixture with zone-based controls	20	65%	1.87 kWh 6.38 kBtu	\$0.21	\$3.12	15.2	\$244,432
<ul style="list-style-type: none"> <li>Suitable for either new construction or major retrofit projects.</li> <li>Requires either low-voltage wires or wireless communication between the sensor and the luminaires.</li> <li>Ideal for low occupancy transitory spaces (e.g., restrooms, corridors, stairs, etc.).</li> </ul>							
New fixture with LLLC control, room-based	20	65%	1.87 kWh 6.38 kBtu	\$0.21	\$3.73	18.1	\$275,132
<ul style="list-style-type: none"> <li>Suitable for either new construction or major retrofit projects.</li> <li>LLLC includes the sensor as part of the luminaire.</li> <li>Room-based controllers will be sized on both electrical capacity and number of zones—this will affect control design.</li> <li>Requires communication—either wired or wireless—between the controller, sensors, and luminaires.</li> </ul>							
New fixture with LLLC control, centrally networked	20	70%	2.03 kWh 6.92 kBtu	\$0.22	\$4.28	19.2	\$290,535
<ul style="list-style-type: none"> <li>Economies of scale play a role; technology is more cost effective as the building size increases.</li> <li>Recommended for facilities implementing a demand response strategy.</li> <li>Allows for more lighting control strategies than other options.</li> <li>If a digital system is selected, diagnostics or other information can queried from the system.</li> </ul>							
New fixture with networked controls + HVAC + IoT features	20	70% lighting 20% HVAC	4.03 kWh 13.74 kBtu	\$0.44	\$4.65	10.5	\$217,639
<ul style="list-style-type: none"> <li>Provides more total energy savings and a shorter cost recovery period than just a lighting control system.</li> <li>More cost effective with larger buildings.</li> <li>Energy codes are starting to require occupied setback; this option leverages the occupancy sensors in a lighting system for HVAC integration.</li> </ul>							

\*\* 20-year life expectancy of new fixtures exceeds 15-year LCC analysis



# LED Lighting

## IN THIS SECTION, WE COVER:

LED System Features | 12

Interior LED Retrofit Options | 16

Type ATLED | 17

Type BTLED | 18

Type CTLED | 19

Troffer Retrofit Kits | 20

New Troffer and Linear Luminaires | 21

PoE Lighting | 22

Other Interior Lighting | 23

Emergency and Egress Lighting | 24

Exterior Lighting | 26

# LED System Features

Lighting systems have a tremendous impact on building resources. Depending on the building's age and lighting system, lighting will consume between 10% and 25% of the electricity in GSA buildings. Conversions to LED lighting typically save 50% of electricity over a fluorescent baseline. Furthermore, using less electricity results in lights generating less heat that can allow for reductions in air-conditioning energy. For this and other reasons, it is a good time to transition to LED.

The following LED system features will help you think more broadly about the technology. When designing lighting systems, consider agency design guides and union standards, which will include requirements for light output, color, and other aesthetic attributes. GSA's *LightMatters*, which will be released in 2024, will contain more detailed information on lighting design.

## Circadian Lighting

The human body has a circadian rhythm or internal clock that regulates physical, mental, and behavioral changes on a 24-hour cycle. Although many factors influence the circadian system, lighting plays the largest role.

GSA's PBS-P100 Tier 2 projects require circadian lighting (i.e., human-centric lighting), which is best managed via a centrally networked system. To influence the human circadian system, lighting intensity, spectrum, duration, and timing of exposure all need to be controlled. The building science of circadian lighting is still developing. If you're considering a circadian lighting system, involve design experts.

## Color Rendering

Color rendering (i.e., Color Rendering Index [CRI]) measures how light affects the way you see color. CRI relies on eight standard colors to evaluate color accuracy. GSA's PBS-P100 (Tier 2/3) requires interior lighting to have a CRI greater than 80. Exterior lighting should have a CRI greater than 70.

Recently, the lighting industry adopted a more comprehensive color index, TM-30. TM-30 uses 99 colors and includes color fidelity (Rf), color gamut (Rg-saturation), and gamut shape, a visual description of hue and saturation. The PBS-P100 requires Tier 1–3 lighting to have an Rf value greater than 85.

**Figure 3**  
TM-30 Provides Better Color Rendering

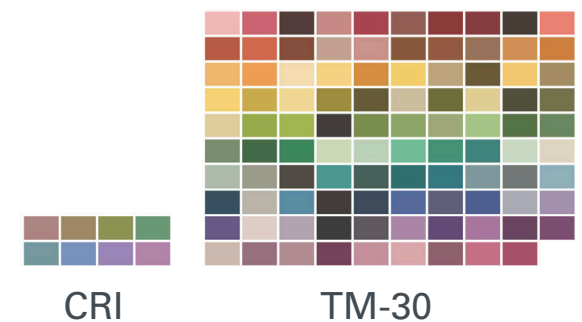

# LED System Features

## Color Temperature

The correlated color temperature (CCT) is a measure of the appearance of a light source and is expressed in Kelvin (K). Low values (1800–2700 K) are warm in appearance, and high values (4500–6500 K) are cool. A higher or lower number does not indicate better performance. CCT is an imprecise metric with multiple structured tolerances per the American National Standards Institute (ANSI) standard. As a result, two products can have the same CCT value and may not appear visually the same.

GSA's PBS-P100 requires interior lighting to be < 4100 K and exterior lighting < 3500 K. Some manufacturers offer light fixtures with multiple CCT values. Electricians can select from among two or three CCT options in the field using a dip switch setting at the luminaire. Most occupants prefer warmer color temperatures in interior applications, with 3000 K and 3500 K being the most common preferences.

Some applications or tasks may require CCT values greater than 4100 K. These tasks include fine detail work (e.g., surgery) and precision work (e.g., circuit board construction). However, for good color, high CRI and ANSI/IES TM-30 values are more important than CCT values.

## Communication Protocols

Communication protocols are the method by which devices communicate with each other. Typical communication protocols include 0–10V, DALI-2, ANSI C137.4, BacNet, Zigbee, Bluetooth, Wifi, and Thread.

## Controls Interfaces

Controls interfaces are how users interact with the control system. Explore the controls interface and its usability before specifying a lighting control system. PNNL conducted a study and found that vendors provide different means and labeling for increasing the light level in a space, which can be confusing as users move between vendors. Inquire about how the controls work and how easily changes can be instituted in the system before specifying the full system. Does the system use an app? Can everything be controlled or changed at the device? Are the terms intuitive?

**Figure 4**  
Lower CCT Temperatures are Warmer

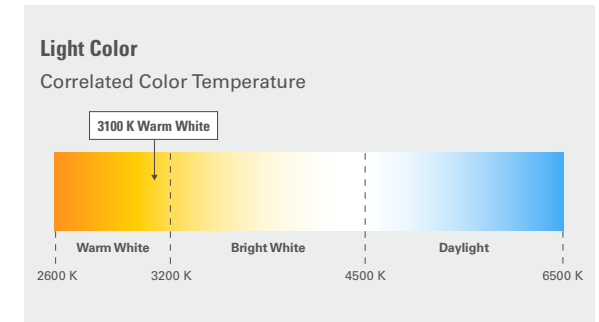

# LED System Features

## Controls-Ready Fixtures

Controls-ready fixtures include wiring so that the light fixture can directly support a sensor and/or communication device after installation. Controls-ready lamps include a wireless receiver.

## Dimming

Dimming saves energy and is a necessary feature of multiple energy savings strategies. Drivers use different dimming methods: forward-phase, reverse-phase, constant current reduction (CCR), and pulse-width modulation (PWM). All equipment on the same wiring needs to use the same dimming method. The quality of dimming (range, curve, consistency, and cost) varies with drivers and dimming protocols. CCR and PWM provide smoother dimming and are more common in commercial fixtures.

Dimming can also be important for occupant satisfaction. Dimming LED lights does not add additional cost, unlike with older fluorescent systems. However, not all tubular LED (TLED) options are dimmable, so if dimming is required, check the product specifications carefully.

## Drivers

A driver is the power supply for LED lighting, fluorescent lighting like a ballast is for fluorescent. Drivers regulate current and voltage to the LEDs. It is important to ensure compatibility between the driver and the controls system. Some controls manufacturers only interface with specific drivers (and luminaires).

**Figure 5**  
The Driver Determines the Dimming Method

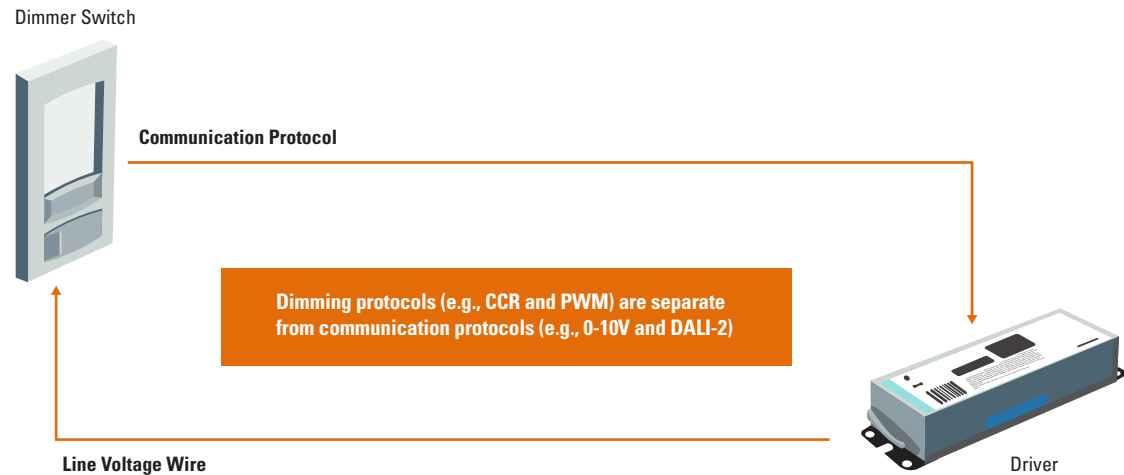

# LED System Features

## Distribution

Distribution refers to how light is shaped and directed. It is represented by beam angles. For example, a light with a beam angle of 10 degrees is a spotlight; a beam angle of 25 degrees indicates a narrow flood; a 60-degree beam angle is a wide flood. An existing lamp and a retrofit lamp should always have a similar distribution. If they do not, the combination of the existing fixture and retrofit lamp will result in an uneven or narrow distribution. Distribution beam angles can be found in the lamp catalog code and on the lamp's datasheet. For a TLED, at least 270-degree output is necessary.

## Efficacy

Lighting efficacy is measured in lumens per watt (lm/W); the higher the value, the more efficient the lamp. Efficacy is influenced by luminaire size and type. A downlight lamp ranges between 50 lm/W and 85 lm/W and a troffer between 85 lm/W and 140 lm/W. Parking lot and high bay luminaires range between 115 lm/W and 150 lm/W. Section 6.3.2.2 of GSA's PBS-P100 requires that solid-state luminaires (LEDs) meet the requirements of the DesignLights Consortium (DLC).

Efforts to limit glare and improve color, directionality, and other features can all reduce efficacy. When comparing two products, efficacy is only one feature to consider. A luminaire with slightly lower efficacy might be more desirable because of other luminaire features.

## Flicker

Flicker refers to rapid and repeated changes in the brightness of a light source over time. Very low flicker can induce seizures; higher flicker can cause headaches and migraines. The lighting industry is developing metrics and better methods to determine and evaluate flicker. Flicker is also a catch-all term and includes temporal light modulation, direct flicker, the stroboscopic effect, and the phantom array effect.

Flicker is a function of the frequency of the electrical signal and the duty cycle—how quickly the light waves peak per second (frequency), the width/size of those peaks, and what happens between the peaks.

Fluorescent lamp sources exhibited flicker with magnetic ballasts (operating at 120 Hz), but flicker was significantly reduced when the industry shifted to electronic ballasts (> 20,000 Hz).

Some LED drivers use low frequencies that can cause flicker. To reduce the potential for flicker, the LED driver should be high frequency and not have rectangular or complex waveforms. These drivers currently tend to be more expensive and possibly larger than some drivers on the market. Review the driver information carefully as you consider options.

There is currently no quick and easy way to assess the driver's waveform. This waveform can be analyzed with different meters. Request drivers with noncomplex waveforms from the manufacturer. As specifiers require a description of the waveform, it will become commonplace for it to be reported in the documentation.

**Figure 6**

Distribution Can Be Represented by Beam Angles

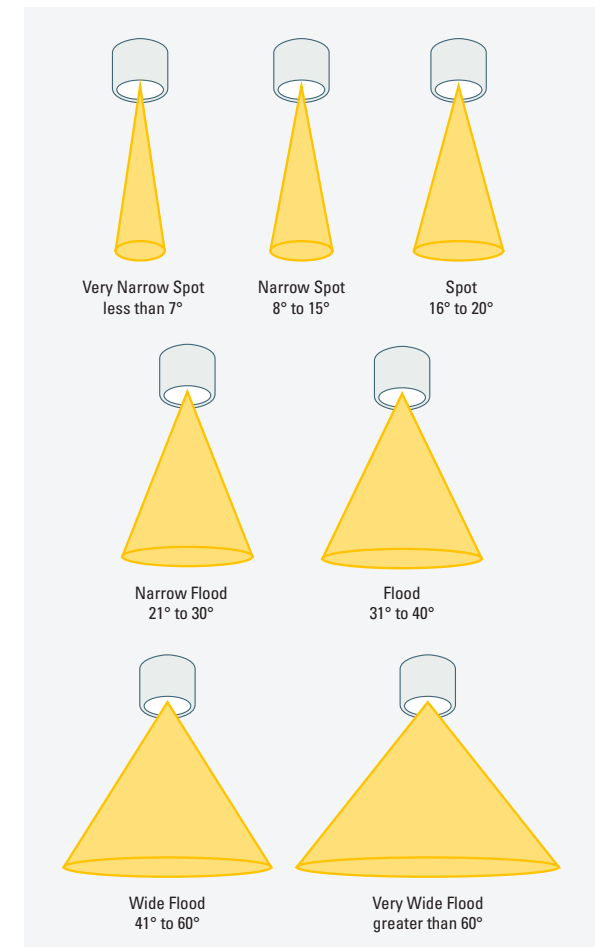

# Interior LED Retrofit Options

## Replacement Lamps and TLEDs

Replacement lamps are available for 85% of interior light sources. Tubular LEDs (TLEDs) can be used in linear fluorescent fixtures (i.e., troffers), which are the most common fixture found in federal government buildings. TLED replacements have become a popular way to upgrade lighting systems because they are low cost and easy to install. They save 25% to 40% lighting energy compared to fluorescent lamps. The 2016 GSA GPG study, "[Linear LED Lighting Retrofit Assessment](#)," found 27% to 29% energy savings by converting to TLEDs. Since 2016, TLEDs have improved, but fluorescent lamp performance has remained static since 2012. TLEDs are also longer lasting: TLEDs are typically rated at 50,000 hours, and fluorescent lamps are rated at between 25,000 and 40,000 hours. Depending on the product and control configuration, TLEDs can be dimmable, which can increase occupant satisfaction. All TLEDs can create glare problems because the luminous surface area of TLEDs is much smaller than fluorescent lamps, and the existing fixture may not effectively mitigate the glare from TLEDs. Some occupants may describe TLEDs as too bright, but this may, in fact, be a problem with glare. To mitigate potential glare issues, TLEDs should be tested in place.

## Retrofit Kits

Retrofit kits are products with a new light source, power supply, and optics designed to be placed into the shell of the existing luminaire. By leaving the shell of the luminaire in place, no new wiring is necessary, and sensitive spaces (e.g., asbestos above ceiling) do not have to be disturbed. Kits are also beneficial because they reduce installation time. The installation time for kits is a little longer than that for TLEDs and typically less than half the time for new luminaires. Some kits may contain integral lighting sensors. Kits (or a similar name) exist for downlights, troffers, linear pendants, low/high bay fixtures, and in some cases, pole-mounted luminaires. Retrofit kits have nearly the same life as new luminaires and may be a partial step to refreshing the appearance of the space. Kits typically yield 40% to 60% energy savings before lighting controls are considered. There is the potential for larger savings via a redesign and new luminaires, but retrofit kits can provide maximized energy savings for a reasonable cost recovery period.

## New Fixtures

New fixtures or luminaires are used for new construction and are the obvious choice for major renovation or redesign where the ceiling is changed, but labor costs will be more expensive than retrofit kits. New luminaires will have a slightly longer life rating than retrofit kits and similar performance at the device level as retrofit kits. New luminaires can improve the appearance of the space.

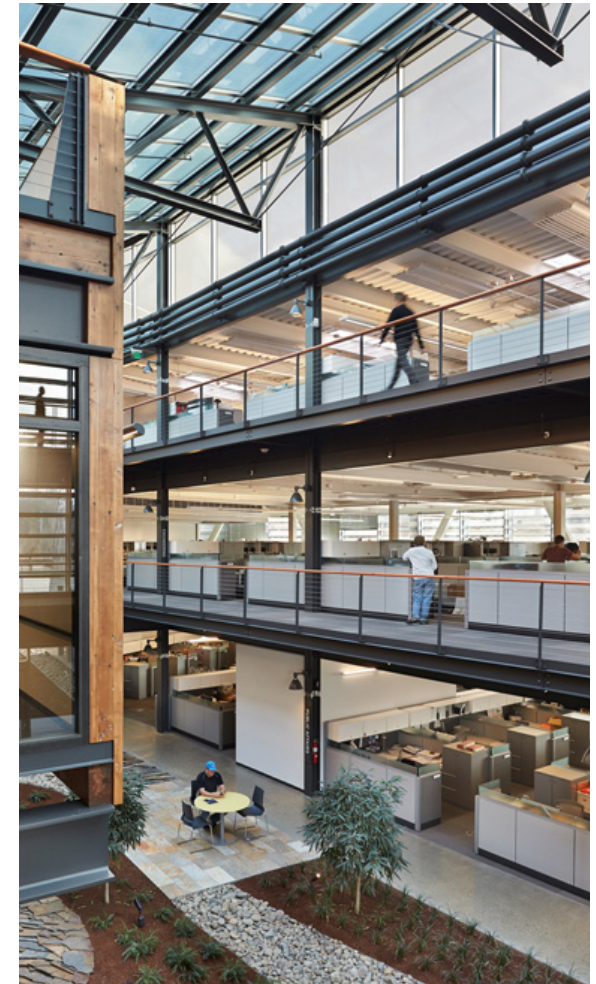

GSA Federal Center South Building, Seattle, WA



# Type A TLED

Type A TLEDs operate on the existing fluorescent ballast and are a direct replacement for a fluorescent tube. Type A TLEDs have the shortest simple payback of any retrofit for a fluorescent lighting system but have a longer ROI over a 15-year analysis.

## Deployment Guidance

**Consider if the facility is going to be held < 3 years** and the socket and fixture are in good condition.

## Implementation Considerations

**Ballast matching can be challenging.** A dimming ballast with a non-dimming lamp will destroy the ballast. Type A TLEDs will not work with magnetic ballasts. Magnetic ballasts will be larger and heavier than electronic ballasts and will emit audible noise. Ballasts should be labeled (e.g., electronic 2 lamp) to help with identification. To determine ballast and TLED compatibility, survey 10% of the fixtures onsite.

**After 2025, Type A TLEDs will need to be replaced** with a different solution because manufacturers have stopped making fluorescent ballasts. The fluorescent ballast has a 10-year life, and most were installed pre-2016.

**Assume the ballast reduces the rated efficiency by 20%** because of conversion losses.

**Dimming is not recommended.** There are multiple issues, including ballast incompatibility, flickering, and noise.

**Cybersecurity scanning is unnecessary** unless a “smart” TLED is installed.

**Can be too bright or the diodes are directly visible and create glare.** Because dimming is not recommended, this can lead to occupant dissatisfaction.

**Most utilities do not provide rebates.** Incentives may exist for Type B or Type C TLEDs because those technologies require electrical modifications to the luminaires.

**Mockups are strongly advised,** especially in courtrooms or high-visibility rooms. GSA has had experience at several federal sites where Type A TLEDs did not project light with the same uniformity as fluorescent bulbs and did not work well in the existing parabolic or reflective fixtures.

**Check the manufacturer’s reputation** and warranty provisions before opting for the lowest-price replacement bulbs. Low-quality bulbs can flicker and have other operational issues. Flicker can be disruptive to occupants and, in extreme cases, induce migraines or headaches.

**Type A TLEDs do not require an electrician for installation.** O&M contractors can replace the bulbs with no extra labor costs.

**The tombstone (i.e., socket holder) may have to be replaced.** Type A TLEDs may use shunted tombstones. Rapid start and dimming fluorescent ballasts use non-shunted tombstones.

**If using a T5 TLED, verify that the length works** in the existing unit since T5s are based on metric lengths and not units of feet.



Type A TLED uses the existing ballast.  
Photo credit Michael Myer, PNNL



Low-quality TLEDs can have a “pixelated” appearance.  
Photo credit Michael Myer, PNNL

**Do not use Type A+B TLED** (i.e., dual-mode) because it introduces more risk.

**Remove fluorescent lamps** from the site after retrofit to prevent accidental lamp replacement.

**Factor the disposal of lamps into installation costs.** Recycle fluorescent lamps; recycling in bulk costs ~\$1.00 per lamp.

**Material cost:** \$10–\$20 per lamp; \$10–\$30 per ballast

**Labor time:** ~5 minutes per lamp

# Type B TLED

Type B TLEDs include internal LED drivers in the tube and are directly wired to supply line voltage, thereby reducing the risk of TLED and ballast coordination and eliminating the need to replace separate ballasts or drivers. Type B TLEDs are the most common, representing more than 67% of TLED installations.

## Deployment Guidance

**Consider if the facility is going to be held < 5 years** and the socket and fixture are in good condition.

**Type B TLED are good for back-of-house and transitory spaces** (e.g., restrooms, storage, mechanical rooms, and corridors) that typically do not have access to daylight or need to dim.

**An easy option for large projects** because they fit existing sockets and can be delivered “sight unseen.” The installation team doesn’t need to measure or identify the existing lighting fixtures.

**Avoid using in public spaces, open offices, private offices, and conference rooms.** These spaces typically have more complex control requirements, and occupants may have problems with glare or distribution issues from the Type B TLED retrofit.

## Implementation Considerations

**Rely on optics of the existing troffer**, which reduces the efficacy of lumen output by 10% to 15%.

**Can be too bright** or the diodes are directly visible and create glare and lead to occupant dissatisfaction.

**Dimming requires a dimming control wire** connected to the fixture. If wires exist, the fixture will need to be carefully rewired between the line voltage and communication protocol wires.

**May not be eligible for utility rebates.**

**Remove any magnets used during installation** to hold the tubes in place. Magnets inadvertently left in the luminaire can cause Type B TLEDs to strobe.

**Evaluate a few lamps on site.** Some Type B TLEDs may flicker because the drivers are very small (less than 1” in width).

**Mockups are strongly recommended**, especially in courtrooms or high-visibility rooms.

**Select a manufacturer with at least 4 years of experience.** Many TLED manufacturers have limited experience, and, as a result, some lower-quality products exist on the market.

**Mixing TLED types is not recommended** when transitioning to LEDs. Also, do not use Type A+B TLED (i.e., dual-mode) because they introduce more risk.

**If using a T5 TLED, verify that the length works** in the existing unit since T5s are based on metric lengths and not units of whole feet.

**The tombstone (i.e., socket holder) may have to be replaced** with a non-shunted tombstone to work with the Type B TLED.

**Ensure a qualified electrician disconnects and removes the ballast.** This may add a small recycling/waste disposal cost, but it is better to remove the ballast during the retrofit process.

**Label each fixture** to indicate that fluorescent tubes should not be installed for safety reasons.

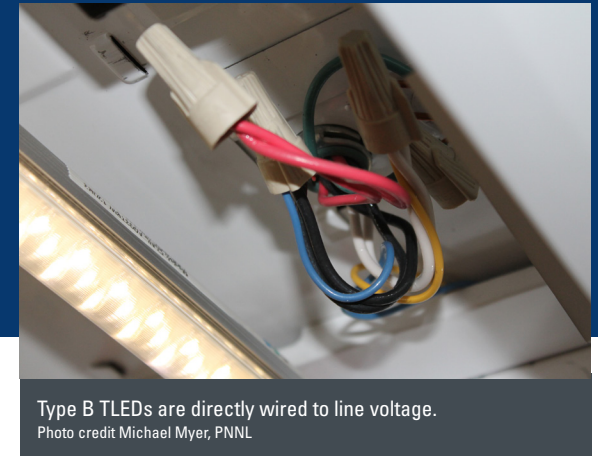

Type B TLEDs are directly wired to line voltage.  
Photo credit Michael Myer, PNNL

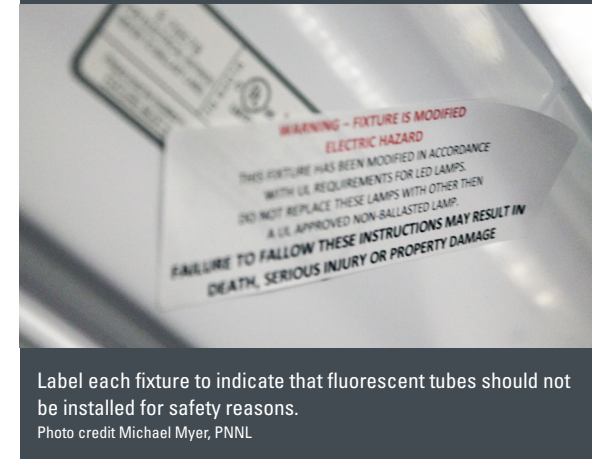

Label each fixture to indicate that fluorescent tubes should not be installed for safety reasons.  
Photo credit Michael Myer, PNNL

**Remove fluorescent lamps** from the site after retrofit to prevent accidental lamp replacement.

**Factor recycling lamps and luminaire parts into installation costs.** Bulk lamp recycling costs ~\$1.00 per lamp. Recycling costs for PCB-containing ballasts are ~\$1.00/pound and ~\$0.50/pound for non-PCB-containing ballasts.

**Material cost:** \$10–\$20 per lamp

**Labor time:** ~10–15 minutes per lamp



# Troffer Retrofit Kits

A troffer retrofit kit fits within the existing fixture housing (the exterior shell). Most retrofit kits are designed to be installed from below the ceiling plane. Kits provide new components for critical elements, so no maintenance is needed for many years.

## Deployment Guidance

**Focus on buildings that need upgrades in aesthetics** or where tenants have a vested interest in the final look of lights. Retrofit kits can refresh the look and feel of a space without having to replace the entire luminaire.

## Implementation Considerations

**Properly determine retrofit kit light output** rather than matching lumen-for-lumen output. Existing spaces may be overlit, so correctly sizing light output can save energy.

**Costs can be reduced by working with a team with varying skill levels** rather than requiring a full team of electricians, particularly on large projects.

**Kits are a longer-life option.** Heat reduces the life of LEDs and the driver. Retrofit kits provide more surface area and heat sinks, reducing the heat on the diodes and drivers.

**Can include integral occupancy and daylight sensors.** This reduces the costs of adding controls by a factor of two.

**If you have lighting fixtures that provide HVAC air flow through the fixture, look for a retrofit kit that can accommodate the airflow** rather than installing separate ducting. Otherwise, consider a TLED or new air-handling LED troffer.

**Survey existing luminaires onsite to find matching retrofit kits.** Light fixtures vary by manufacturer in shape and size.

**Installing retrofit kits is faster than installing new fixtures.** The GPG technology evaluation at the Fort Worth Federal Center ([GPG-037, Advanced Lighting Controls and LED](#)) confirmed that installation took less than 10 minutes.

**Install mockups.** Lenses and housing often look different in catalogs than in person. Courts have found several retrofit kit installations that looked “too cheap” for courthouses. Historic preservation specialists have not approved some installations in historic buildings.

**Time the installation of mockups** so the contract can be based on the actual time rather than an estimated time. A GPG technology evaluation ([GPG-024, LED Fixtures with Integrated Advanced Lighting Controls](#)) at the Ralph H. Metcalfe Federal Building in Chicago, IL, estimated 1 hour per kit for installation. However, the actual installation time was less than 15 minutes.

**Factor the disposal of old luminaire parts** into installation costs.

**Rebates may only be available for retrofit kits**, which may make them a better ROI than TLEDs. Rebates for retrofit kits can be \$20–\$40 per kit, whereas rebates for TLEDs are only \$1–\$4 per lamp.

**Material cost:** \$75–\$200

**Labor time:** ~15 minutes

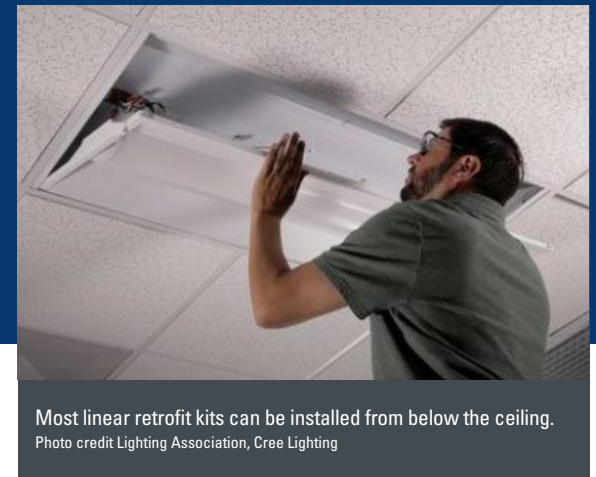

Most linear retrofit kits can be installed from below the ceiling.  
Photo credit Lighting Association, Cree Lighting

**Table 4**  
DesignLights Consortium v5.1 Requirements

Retrofit Kit Applications	Minimum Light Output*	Minimum Efficacy Standard**	Minimum Efficacy Premium**
Troffer	> 1,500	110	125
Linear Ambient	> 375 lm/ft	115	130
High-Bay	> 10,000	120	130
Low-Bay	5,000–10000	115	130

\*Lumens (lm)

\*\*Lumens per watt (lm/W)

# New Troffer and Linear Luminaires

New luminaires are optimized for LED and will control glare and provide optimal distribution. They will last longer than retrofit kits or replacement lamps. Many new fixtures are controls-ready out of the box, which can save significant programming and integration time.

## Deployment Guidance

### Consider for major interior space retrofit/redesign.

Not only do new fixtures enhance the appearance of the space, but if the ceiling is being modified in any way, the existing luminaires will need to be moved or temporarily removed.

## Implementation Considerations

### New luminaires will cost more than a replacement lamp or retrofit kit in labor and materials.

**Could require modification to the ceiling system,** either changing the ceiling layout or mitigating construction materials, such as asbestos.

**Ceiling system modifications** can optimize lighting equipment placement (known as a redesign), allow for new equipment, and refresh the appearance of the space.

**Match the measurement system** used in the ceiling grid to the lighting fixtures (i.e., metric or English).

**Document where all parts of the new lighting system exist,** including drivers.

**Require a photometric study** and design to ensure proper light distribution. New LED fixture distribution may differ from the existing fluorescent distribution.

**Review plans to ensure that fixtures can be accessed for maintenance and cleaning.**

**GSA's PBS-P100 requires all new interior and exterior lighting to be high-efficacy LED luminaires** that meet DLC requirements.

**EPAct 2005 requires federal agencies to procure ENERGY STAR or FEMP-designated products,** unless (1) the product is not cost-effective over the life of the product or (2) no product is reasonably available that meets the functional requirements of the agency. FEMP surveys the market and rates the top 25% of the market as FEMP-designated products (See 42 U.S. Code § 8259b). FEMP-designated products are available for commercial troffers, linear ambient luminaires, and low/high-bay industrial luminaires.

**Material cost:** Troffer: \$100–\$275; Linear pendant: \$10–\$400 (style, materials, and appearance will affect price)

**Labor time:** < 1 hour per luminaire

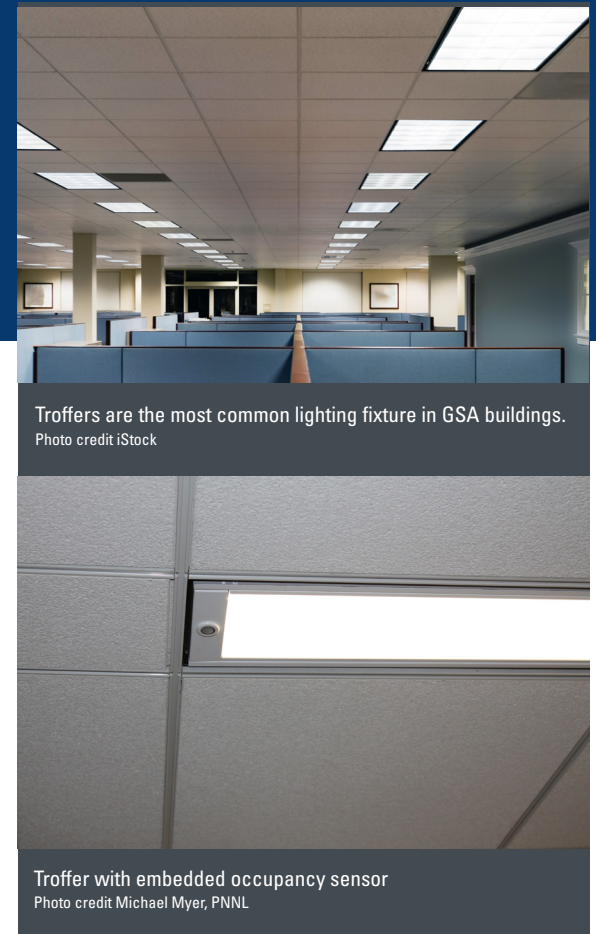

# PoE Lighting

Power-over-Ethernet (PoE) combines power and control signals in a single ethernet cable. Most electronics, and especially LEDs, convert AC to DC within the device. PoE eliminates the AC to DC conversion and should yield 10–20% energy savings. Instead of each light fixture having its own power source, PoE systems use a centralized power supply to send electricity to multiple light fixtures. Each connected device can send and receive data.

## Deployment Guidance

**Consider for major interior space redesign or new construction.** PoE will require new ethernet cable wiring, and new fixtures with a PoE driver. Some manufacturers also offer PoE retrofit options.

**Use with other PoE equipment.** If the project is using other PoE devices (e.g., phones, cameras), consider using PoE lighting too.

## Implementation Considerations

**Labor and material savings** are expected from PoE. Low-voltage wiring doesn't require running copper conduit, which is expensive. PoE also doesn't require skilled electricians and can be installed by less-expensive technicians. Note: Some jurisdictions require electricians and conduit even with PoE, which can negate the potential labor savings of this technology.

**Ethernet cable termination can be a weak point** in PoE installations. Each cable requires a termination and connector. Consider using pre-terminated cables of fixed lengths (e.g., 25' or 50') from cable vendors to reduce risk and reduce installation time.

**Heat can degrade ethernet cabling.** Individual bundles should not exceed bundles of 24 to extend the expected lifespan of cables. Also, select unique PoE cable jacket colors for quick identification.

**Place PoE switch equipment in an IT/telecom closet.** A PoE switch is an ethernet switch-powered box with multiple ports that allow for communication. PoE equipment should be located in its own rack. Emergency lighting devices should be separate and clearly labeled.

**PoE requires more planning and design** because it involves more than just power being supplied to the luminaire like with line-voltage fixtures. PoE network system architecture can vary between manufacturers, which should be taken into account in the planning.

**Look for vendors with networking experience.** Most PoE offerings are partnerships between lighting and networking vendors. Focus more on the networking capabilities than the lighting. GPG tested an early PoE offering from a lighting vendor that did not have experience with networking, and the project was unsuccessful.

**PoE will require additional cybersecurity.** Each individual device will need to be scanned. Some PoE devices have received FedRAMP approval.

**O&M will need training** to operate more complex technical lighting control systems.

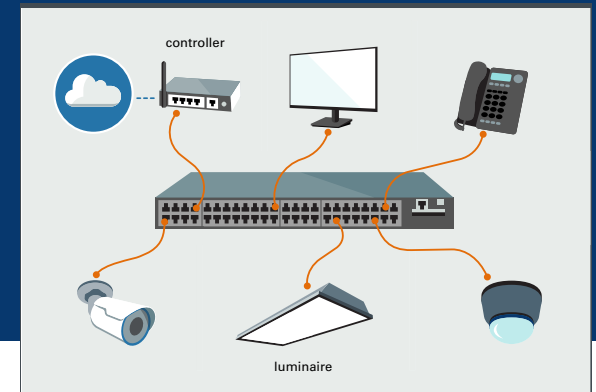

**Figure 8**  
Power-over-Ethernet networks can combine multiple systems (e.g., lighting, security, phone, etc.). At the center is a network switch with ports; orange cables combine power and data.

**Material cost:** Troffer: \$100–\$275; Linear pendant: \$10–\$400 (style, materials, and appearance will affect price). PoE should have lower wiring material costs and should be factored into design considerations. PoE uses CAT 5/6/7 cables that may not require conduit (dependent on local jurisdiction), and CAT cables are less expensive than copper wire.

**Labor time:** < 1 hour per luminaire; savings on wiring and materials

# Other Interior Lighting

This document is primarily focused on linear lighting because it represents the majority of commercial fixtures. However, there are other interior lighting fixtures to consider. When designing lighting, don't locate all of the light fixtures in the same plane. Multiple planes add visual interest and enhance the space.

**Downlights** are recessed into the ceiling and include reflectors designed for the original light source to provide the necessary distribution for the luminaire. A GPG technology evaluation ([GPG-026, LED Downlight Lamps for CFL Fixtures](#)) used an LED lamp that was a direct replacement for pin-based compact fluorescent lamps. The assessment found up to 50% energy savings, matching light levels, and payback under 3 years. For better longevity and light distribution than those of replacement lamps, consider a retrofit kit because it will contain new optics and a heat sink. Downlight inserts range in cost between \$15–\$30.

**Low/High Bay** spaces are common in industrial, warehouse, or retail spaces. The tall ceiling heights in these spaces (e.g., low bay ceilings under 25 feet and high bay ceilings over 25 feet) make it challenging to position and power stand-alone lighting control sensors.

- Linear-style fixtures use four, six, or eight fluorescent T5 or T8 lamps. Since 2010, many linear fixtures have integrated sensors. Type C TLEDs are a good retrofit option for linear-style low/high bay luminaires because they can work with multiple lamps and existing controls.
- Round-style fixtures use either metal halide or high-pressure sodium lamps, which are not control-friendly and have very specific optical systems. New luminaires will have better optics and will allow for integration with controls.

**Linear Pendants** are suspended and have two components: direct (down portion towards task) and indirect (uplight towards the ceiling). Pendants are designed around fluorescent lamps and different optical systems. Some retrofit options exist, but they vary and may be a challenge with more direct pendants. Consider new luminaires first.

**Linear Coves and Wall Slots:** Consider new luminaires because there are few retrofit kits available.

**Decorative Lighting:** Choose decorative lighting based on aesthetics; it provides minimal functional lighting. Manufacturers typically do not measure or state the efficacy of decorative lighting. Incandescent/halogen lighting is 10–20 lm/W, and LED decorative lighting is 65–110 lm/W.

**Wraparounds:** Consider either a TLED or a new luminaire. TLEDs are a good choice because the optical systems for wraparounds are not sophisticated, simply plastic or acrylic diffusers. New luminaires are also a good option because wraparounds can be quickly replaced (< 0.5 hours). Retrofit kits are not recommended because wraparounds vary widely between luminaires.

**Strip Lights** have exposed lamps that can create glare with an LED light source. Replace strip lights with a new wraparound fixture.

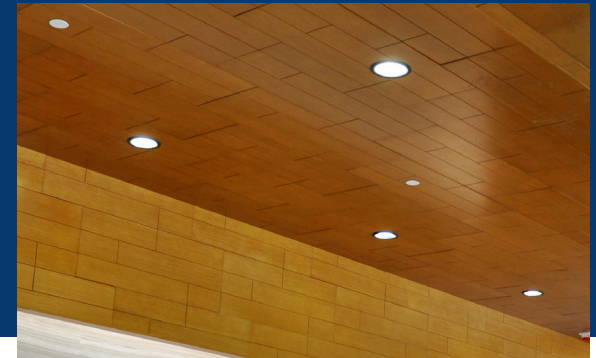

Downlights should be replaced rather than retrofitted.  
Photo credit iStock

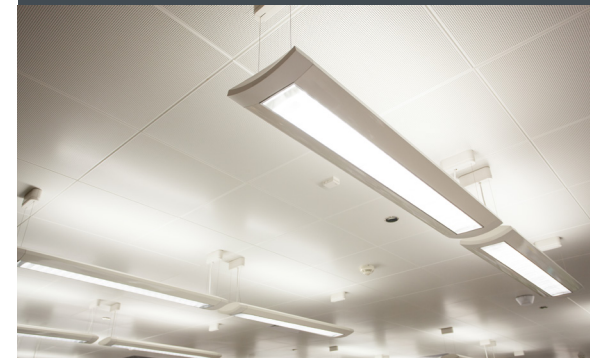

Linear pendants have both an uplight and downlight and can be challenging to retrofit to LED. New fixtures are best.  
Photo credit iStock

**Historically Sensitive Fixtures:** Some fixtures may be considered as historically sensitive and would need to retain their outward appearance. Because of their age, the internal wiring should be replaced as part of a conversion to LED light source(s). Ensure fixtures are cleaned as part of the conversion process.

# Emergency and Egress Lighting

Emergency lighting must turn on within 10 seconds of a power loss and remain on for at least 90 minutes. Most emergency lighting illuminates pathways and exits that lead out of the building—the egress paths. Physical limitations onsite may dictate the emergency power options.

## Deployment Guidance

**LED lights at entrances and exits must be connected to an emergency lighting system.**

**If the building uses emergency ballasts, install either Type C, LED retrofit kits, or new luminaires with emergency drivers.** The inclusion of emergency drivers with Type B TLEDs may be more complex.

**Occupancy sensors can be used in both stairs and means of egress** as long as the devices meet National Fire Protection Association (NFPA) 101. Because stairwells are not used regularly, bi-level occupancy sensors in stairs can reduce energy use by more than 50%.

## Implementation Considerations

**Emergency lighting does not need to generate the same amount of light as normal operations.** The exact parameters need to be verified by photometric calculations, but in general, an emergency driver will have 1/3 the rated power of the normal driver. For example, if the normal driver is rated at 22 W, the emergency driver may be rated at 8 W.

**Discuss emergency lighting options before the final set of specifications.** Although emergency lighting is a small portion of the overall lighting project, it should not be an afterthought.

**Confirm the control system is wired correctly to the automatic emergency controls.** In a correct wiring scenario, when lights are manually turned off, the emergency lighting should not turn on. Emergency lighting should only turn on when there is a failure of the branch circuit.

**Energy codes require egress lighting to be turned off when the building is unoccupied.** Do not use a nightlight circuit with egress, emergency, and night lighting. ASHRAE/IES Standard 90.1 requires most lighting to be off when the building is unoccupied. A small portion can remain on if the lighting load does not exceed 0.02 W/ft<sup>2</sup> multiplied by the gross lighted floor area of the building.

**UL 924-listed relay devices**, the Standard for Safety of Emergency Lighting and Power Equipment, should be used to enable emergency lighting to turn on quickly.

**Check older LED exit signs for light output.** LED exit signs don't stop working but produce less light over time. LED exit signs installed earlier than 2010 may not be producing the necessary amount of light required.

**NFPA 101 power failure requirements include the following:** emergency lighting must turn on within 10 seconds of power failure to the branch circuit and provide an average of 1.0 footcandle (fc) (and no less than 0.1 fc along the path of egress) for at least 90 minutes.

**Type A TLED with emergency power supplied by an emergency ballast**

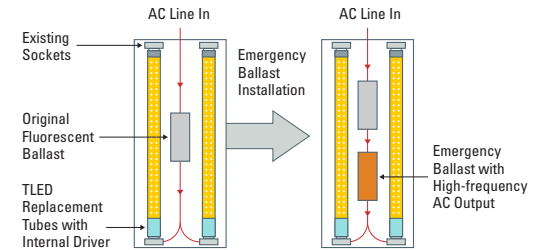

**Type B TLED with emergency power supplied by an emergency inverter**

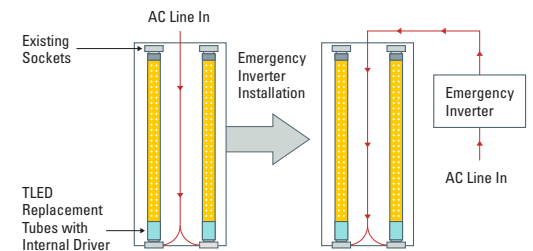

**Type C TLED with emergency power supplied by an emergency driver**

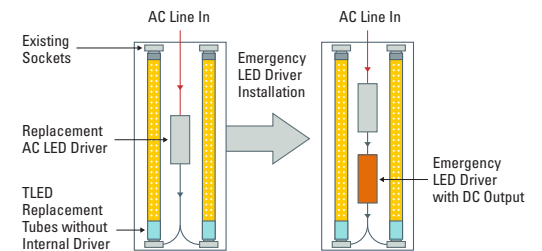

**Figure 9**  
Emergency Power Configurations for TLEDs



# Emergency and Egress Lighting

**NFPA 101 inspection requirements include:** Monthly inspection of every emergency light for a minimum of 30 seconds, and an annual 90-minute test system. With the appropriate software settings, networked lighting controls can routinely test and verify emergency lighting without the need for staff to walk the building. Note that emergency LED drivers for networked lighting can be more expensive than standard LED drivers, and integrating networked lighting controls into emergency lighting systems can be more complex than stand-alone lighting systems.

**Material cost:** Integral battery drivers for digital drivers (e.g., DALI-2) cost more than other integral battery drivers for standard LED luminaires.

**Labor time:** Monthly and annual tests of emergency lighting are required, which may require building staff to test when the space is unoccupied—networked lighting controls allow for remote testing rather than physically having to visit each fixture.

Table 5 compares three different emergency lighting power sources, their functional requirements, and recommendations for deploying each method.

**Table 5**  
Emergency Lighting Power Methods

Emergency Lighting Power Source	Requirements	Recommendations
<b>Generator</b>	<ul style="list-style-type: none"> <li>Requires a defined location for the generator and fuel storage.</li> </ul>	<ul style="list-style-type: none"> <li>Commonly used at GSA sites. Recent weather-related issues have demonstrated generator vulnerabilities.</li> </ul>
<b>Centralized battery/inverter</b>	<ul style="list-style-type: none"> <li>Requires a minimum design life of 10 years.</li> <li>Size the system to provide necessary load at the end of the design life.</li> <li>If powering other equipment and non-linear loads, will need to be a larger size.</li> </ul>	<ul style="list-style-type: none"> <li>To transform standard lighting into emergency lighting, use automatic load-control relays and branch-circuit emergency lighting transfer switches. They can bypass the controls in the event of a power loss.</li> </ul>
<b>Batteries integral to the luminaires (emergency drivers)</b>	<ul style="list-style-type: none"> <li>Requires a separate emergency driver that will be physically attached to the luminaire.</li> <li>Unless networked controlled, the maintenance staff needs to be able to physically push the test button.</li> </ul>	<ul style="list-style-type: none"> <li>Suitable solution for small-size projects &lt; 100 emergency fixtures.</li> </ul>

# Exterior Lighting

Exterior LED lighting can enhance security and provide increased visibility due to better distribution and uniformity of light. Exterior lighting is less complex than interior lighting but it can have greater maintenance costs.

## Deployment Guidance

**Exterior fixtures should be replaced rather than retrofitted.** Moisture and dirt seals on LED luminaires are different (and better) than the seals on fluorescent or high-intensity discharge (HID) luminaires.

### Provide exterior lighting in the following order:

- First, address safety concerns, place lighting at stairs, where humans and vehicles interact (e.g., parking lots, crosswalks), and near doors. GSA has used lighted handrails on ramps and stairs. Although more expensive, this option can provide better lighting, aesthetic benefits, and user satisfaction.
- Next, address security. Not all surfaces have to be lighted. Avoid placing a fixture that lights the area but makes it harder to see the field of view.
- Finally, selectively provide aesthetic lighting. Consider lighting the flag pole, vertically washing the building exterior, or providing lighting that highlights columns. Aesthetic lighting may need to be bright so the element stands out and draws your attention, but it should be used sparingly.

## Implementation Considerations

**Poles, trenching, and bases to pole-mounted lighting are significantly more expensive than the actual lighting fixtures.** Lighting design often balances sufficient lighting within a certain budget. For example, using a 32-ft mounting height for a fixture may result in fewer poles, bases, and trenching than a 25-ft mounting height.

**Be aware of the directionality and brightness of new LED lighting** and design accordingly.

**Planning for maintenance is more important for exterior applications.** A lift truck can be thousands of dollars per visit.

**Replacement of pole lights can provide significant O&M savings.** Region 7 replaced all pole lights at the Fort Worth Federal Center. The conversion to LED lighting eliminated a \$5,000 lift rental every quarter for the O&M to replace burnt-out lights.

**Surfaces do not need to be continuously lighted.** Lighting recommendations allow for some dark spots. Brighter is not better in exterior lighting.

**Always use either a combination photocell + time clock or an astronomical time clock.** Note that the schedule can be set to turn on/off closer to sunset/sunrise than older HID lighting, which required a long warm-up period.

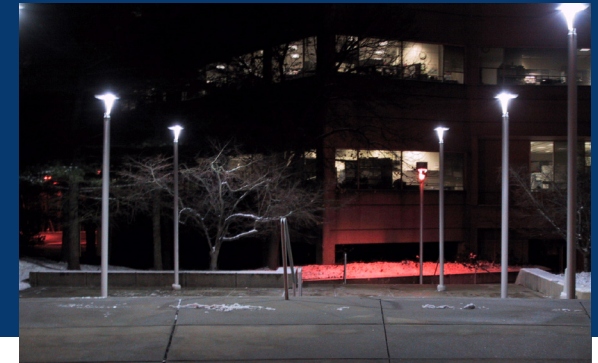

Lighting stairs is more important than continuous walkways.  
Photo credit Michael Myer, PNNL



LED exterior fixtures often have opaque tops and produce no uplight. This fixture has a U0 uplight value.  
Photo credit Michael Myer, PNNL

# Exterior Lighting

**GSA's P100 requires verification at commissioning** that nighttime setback reduces the lighting power to 50%.

**GSA's PBS-P100 requires exterior lighting to have a correlated color temperature < 3500 K and a color rendering index > 70.**

**Exterior lighting uses a backlight-uplight-glare (BUG) rating.** GSA PBS-P100 requires that Tier 1 projects meet the BUG rating per lighting zone (LZ). Tier 2–3 projects have to meet LZ1 per PBS-P100. There are no BUG ratings per LZ, but guidelines are listed in Table 7.

**Material cost:** The costs associated with poles, trenching, and bases for pole-mounted lighting are significantly higher than the fixtures themselves. Lighting design often balances sufficient lighting within a certain budget. For example, opting for a 32-ft mounting height for a fixture might lead to fewer poles, bases, and trenching compared to a 25-ft mounting height. Although lighting-integrated handrails come at a higher cost than standard handrails, they offer superior lighting, aesthetic advantages, and increased user satisfaction.

**Labor time:** Long-life LED sources eliminate costly truck-based maintenance fees. Installation time is 1+ hours per luminaire for exterior lighting because of access to the luminaire, waterproofing, and other site-specific tasks.

**Table 6**  
Nighttime Setbacks: ANSI/ASHRAE/IES Standard 90.1

	Time of Day		
	1 hour after building close or 12:00 a.m. (whichever is earlier)	12:00 a.m. – 6:00 a.m.	6:00 a.m. or 1 hour before building opening (whichever is later)
Parking Lot	100% output (maximum)	50% output (maximum)	100% output (maximum)
Facade and Landscape	100% output (maximum)	Off	100% output (maximum)

**Table 7**  
Backlight-Uplight-Glare (BUG) Guidelines

	Lighting Zones				
	LZ0	LZ1	LZ2	LZ3	LZ4
<b>Backlight (B Value)</b>					
> 2 mounting heights (MHs) from lighting boundary	B1	B2	B3	B4	B5
1–2 MHs from lighting boundary and properly oriented	B1	B2	B2	B3	B4
0.5–1 MH from lighting boundary and properly oriented	B0	B1	B2	B3	B3
< 0.5 MHs to lighting boundary and properly oriented	B0	B0	B1	B1	B2
<b>Uplight (U value)</b>					
Allowed uplight ratings	U0	U0	U1	U2	U3
<b>Glare (G value)</b>					
Allowed uplight ratings	G0	G1	G2	G3	G4

# Lighting Controls

## IN THIS SECTION, WE COVER:

Steps for Designing a Lighting Control System | 29

Energy-Saving Capabilities | 46

Enhanced Performance Capabilities | 56

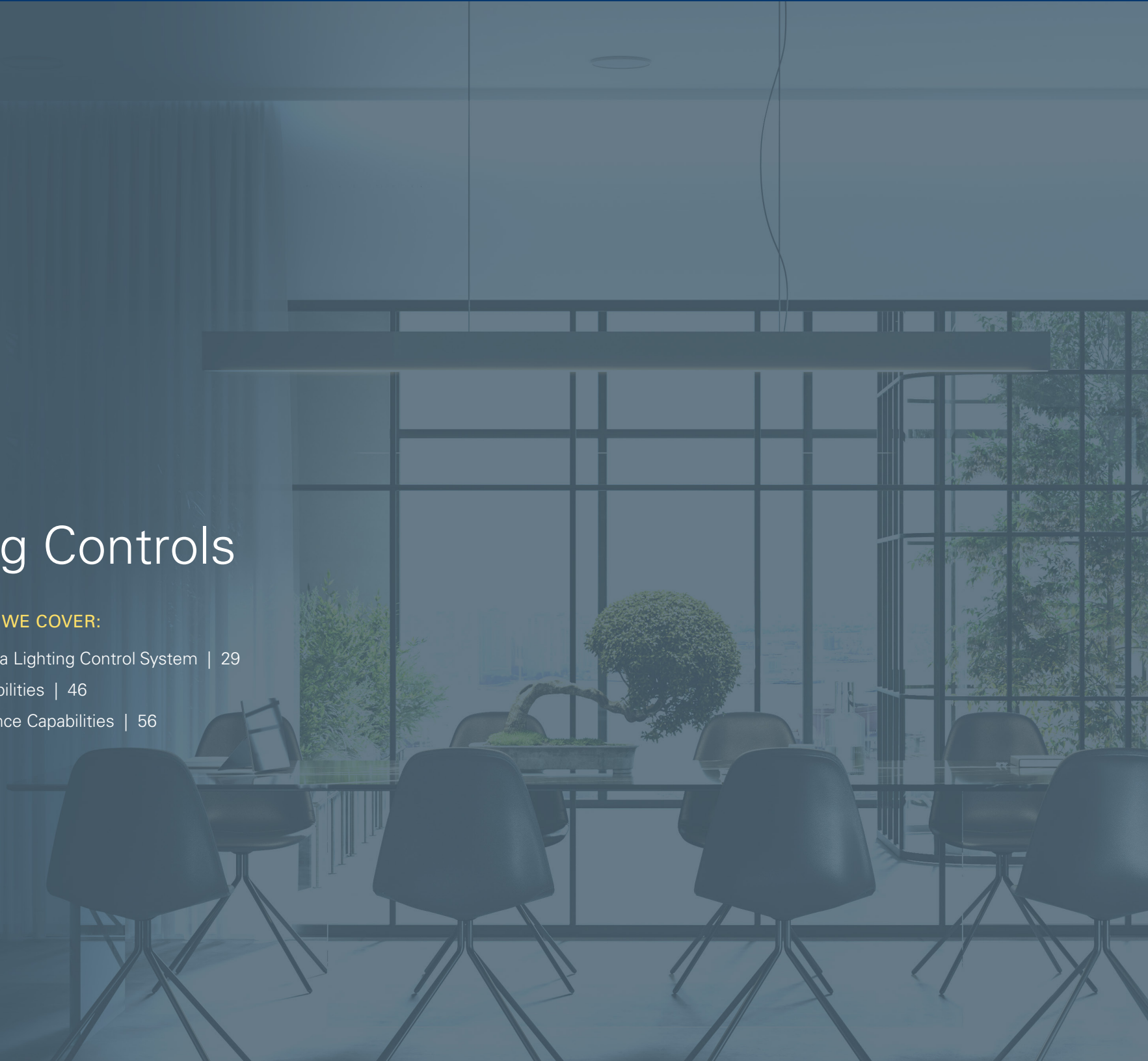

# Steps for Designing a Lighting Control System

There are many considerations to take into account when choosing lighting controls. Follow these steps when designing a control system.

- 1 Review Energy Code Requirements**  
Control requirements will vary by space type.
- 2 Assess Need for Enhanced Capabilities**  
Determine if additional energy savings or lighting performance capabilities are needed.
- 3 Design Lighting Zones**  
Determine the final size of zones, number of luminaires, and layout of each zone.
- 4 Select a System Architecture**  
System architecture can be stand-alone, room-based with a controller, or centrally networked.
- 5 Determine Sensor and Controller Locations**  
Sensors can be located in each luminaire for luminaire-level lighting control or in the space for zone-based control.
- 6 Configure Control Wiring**  
Control systems can be wired, wireless, or a combination of both.
- 7 Identify Communication Protocols**  
The lighting communication protocol refers to how the LED array communicates with the LED driver within the luminaire.
- 8 Plan for Retro- and Re-Commissioning**  
Lighting systems need to be updated regularly to accommodate system updates and building changes.

First, determine system controls that are code compliant, based on space type. Note that energy codes change frequently.

American Society of Heating, Refrigerating and Air-Conditioning Engineers/Illuminating Engineering Society (ASHRAE/IES) 90.1 is published every three years with updated requirements. The 2022 requirements include the following:

- Occupancy sensing for restrooms and offices larger than 300 ft<sup>2</sup>; zones in open offices should be less than 600 ft<sup>2</sup>, and control zones should be less than 2,500 ft<sup>2</sup> if the space is less than 10,000 ft<sup>2</sup> and not larger than 5,000 ft<sup>2</sup>.
- Occupancy sensing zones in parking garages should be less than 3,600 ft<sup>2</sup>, and lighting must be reduced by 50% after 10 minutes of no activity.
- Small private offices require both a local control and an automatic off.
- For spaces that are required to have lighting occupancy sensors, the HVAC system must set back the temperature by at least 1 degree and modulate fans when unoccupied for more than 5 minutes.
- Occupancy sensors that control the lighting do not have to communicate with the HVAC system, but it will be most cost effective to use the same sensors.

**Table 8**  
ASHRAE/IES Minimum Control Requirements by Space Type

Common Space Types <sup>a</sup>	LPD, W/ft <sup>2</sup>	RCR	Local Control	Manual ON	Partial Auto ON	Multilevel Lighting Control	Daylight Response Sidelight	Daylight Response Toplight	Auto Reduction (Full OFF complies)	Auto Full OFF	Scheduled Shutoff
			9.4.1.1(a)	9.4.1.1(b)	9.4.1.1(c)	9.4.1.1(d)	9.4.1.1(e) <sup>b</sup>	9.4.1.1(f) <sup>b</sup>	9.4.1.1(g)	9.4.1.1(h)	9.4.1.1(i)
<b>Office</b>											
Office ≤150 ft <sup>2</sup>	0.73	8	REQ	ADD1	ADD1	REQ				REQ	
Office >150 and ≤300 ft <sup>2</sup>	0.66	8	REQ	ADD1	ADD1	REQ				REQ	
Offices >300 ft <sup>2</sup>	0.56	4	REQ	ADD1	ADD1	REQ	REQ	REQ	REQ	REQ	
<b>Parking Garage</b>											
Daylight transition zone	1.06	4					See Section 9.4.1.2.				
All other parking and drive areas	0.11	4					See Section 9.4.1.2.				
<b>Pharmacy Area</b>	1.59	6	REQ	ADD1	ADD1	REQ				ADD2	ADD2
<b>Restroom</b>	0.74	8								REQ	
<b>Sales Area</b> (For accent lighting, see Section 9.5.2.2[b].)	0.85	6	REQ	ADD1	ADD1	REQ		REQ		ADD2	ADD2
<b>Seating Area, General</b>	0.21	4	REQ	ADD1	ADD1		REQ	REQ		ADD2	ADD2
<b>Security Screening</b>											
Airport/bus/ship/train/transportation screening	0.93	6	REQ				REQ	REQ		ADD2	ADD2
Airport/bus/ship/train/transportation screening queue	0.56	6	REQ				REQ	REQ		ADD2	ADD2
General security screening	0.64	6	REQ				REQ	REQ		ADD2	ADD2
<b>Stairway</b>											
The <i>space</i> containing the stairway shall determine the LPD and control requirements for the stairway.											
<b>Stairwell</b>	0.47	10					REQ	REQ	REQ	ADD2	ADD2
<b>Storage Room</b>											
<50 ft <sup>2</sup>	0.49	9	REQ	REQ						REQ	
≥50 ft <sup>2</sup>	0.35	6	REQ							REQ	

Lighting controls can offer enhanced capabilities such as setting back HVAC or enabling demand management. A few examples are discussed below.

### HVAC Setback

ASHRAE/IES Standards 90.1-2019 and 2022 require the HVAC system to provide temperature setback in spaces that require lighting occupancy sensors. The sensors that inform the HVAC system do not need to be part of the lighting system. However, integrating the lighting and HVAC systems reduces equipment redundancy.

Because more occupancy sensors may be necessary for HVAC integration, a luminaire-level lighting control (LLLC) design may be ideal for this capability.

### Demand Response

Lighting controls can allow for demand response (DR) to shed load when the utility is constrained or a high-carbon source is operating and can be part of a whole building grid-interactive efficient building (GEB) strategy to provide continuous demand management and load flexibility. Lighting systems can either turn off or dim in response to DR events. Dimming lighting is preferred because it allows the space to remain functional and is often unnoticed by occupants. DR is not currently in ASHRAE/IES Standard 90.1, though it can be found in other energy codes. DR will require a centrally networked lighting control system.

### Asset and Occupant Tracking

By using a dense grid of sensors often found in LLLCs and sharing that data over a network, more data about the space and occupants can be gathered. For example, a badge or an asset could have a radio frequency (RF) tag on it. If this is a desired feature, specify an LLLC system that is centrally networked.

Occupant tracking has privacy concerns and may not be possible at some locations. However, in secure facilities this concern may be outweighed. Geofences (digital invisible fences) can be established to indicate if non-cleared personnel enter the space.

In contrast, privacy is not a concern for asset tracking. Examples of asset tracking include tagging portable equipment so that it can be located quickly.

### Energy Reporting and System Diagnostics

New LED drivers (i.e., power supply for the light fixture) are digital, contain energy measurement chips, and can allow for reporting about operations. This enhanced capability could have benefits related to energy efficiency programs or maintenance needs. This capability also requires a lighting control system that uses digital drivers and is centrally networked.

**Figure 10**  
Embedded Sensors in an LLLC System Capture Occupancy Flow and Presence (Enlighted)

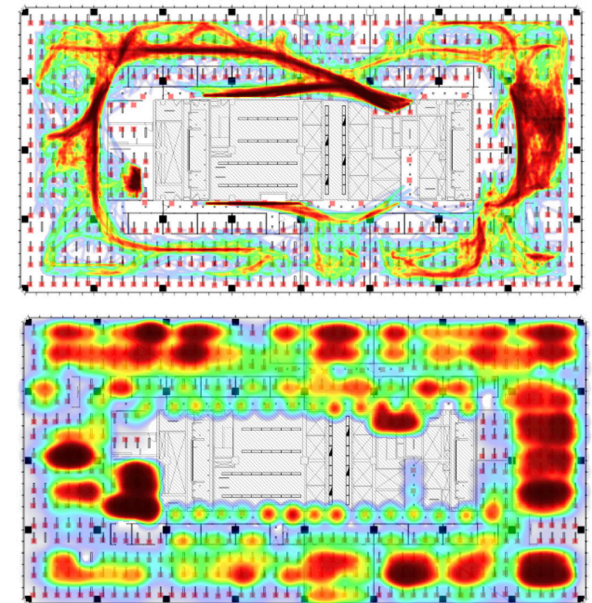

Lighting zones are configured to control a group of fixtures as one unit. Code requirements will impact zone configurations and the control components and systems used.

## Deployment Guidance

**Determine minimum zone sizes per code requirements.**

**Group zones by fixture type.** Fixtures of the same type (e.g., overhead troffers) should be controlled together.

**Group zones by application.** General lighting may be grouped together but in a different zone than ornamental/decorative wall lighting.

**Group zones by location.** In large spaces, zones may be defined by luminaires adjacent to a window wall, by a presentation screen, in meeting areas in large spaces, or other locations that may need to be controlled differently.

**Limit the total number of zones.** More zones in a space may increase costs. A room-based controller may only have a set number of zones available to the controller. If too many zones are created, this could require additional controllers or other devices. In addition, too many zones can confuse users. Users unfamiliar with the space may struggle to determine which switch/button turns on which group of light fixtures.

## Implementation Considerations

**Most rooms or spaces will have two or more control zones,** other than private offices, storage rooms, restrooms, and electrical/mechanical rooms.

**Physical wiring of zones requires an electrician,** can be costly, and is difficult to change after installation.

**The dimming method must be the same for all lights within the zone.** Dimming methods are controlled by the driver.

**Zones in a lighting control system with a digital control signal can be easily changed.**

**The smaller the zone, the more refined the lighting and energy management.** The larger the zone, the simpler and less costly the setup.

**Zones should consist of one luminaire type** to ensure compatibility between the luminaire driver and other control devices. During lighting design, determine which lighting needs to be controlled together.

**Lighting zones can contain multiple planes of light,** which can add visual interest and enhance the space.

**Work with property managers or tenants when setting up the zoning.** No one knows the space better than them. Getting the zoning right the first time will save time and serve the occupants best.

**With LLLC, each luminaire can be its own zone** (the ultimate in granularity) for certain capabilities (e.g., daylight responsive controls) and part of larger zones for others (e.g., occupancy sensing, time scheduling).

**Figure 11**  
Design Lighting Zones by Fixture Type, Application, and Location

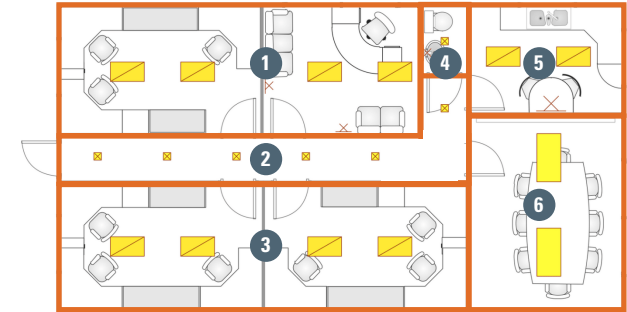

**Zone a security booth's interior lighting separately from the exterior lighting.** In one GSA land port of entry (i.e., border station), the exterior lights on the face of the security booth—used to illuminate vehicles passing through the checkpoint—were controlled by the same circuit as the interior lights, so when a security officer turned off the booth's interior lights, the exterior lights also turned off.



# 4

## Select a System Architecture

It is important to understand how the system architecture contributes to the desired capabilities and satisfies owner preferences. System architecture can either be stand-alone, room-based, or centrally networked.

**Figure 12**  
Lighting Controls Configurations

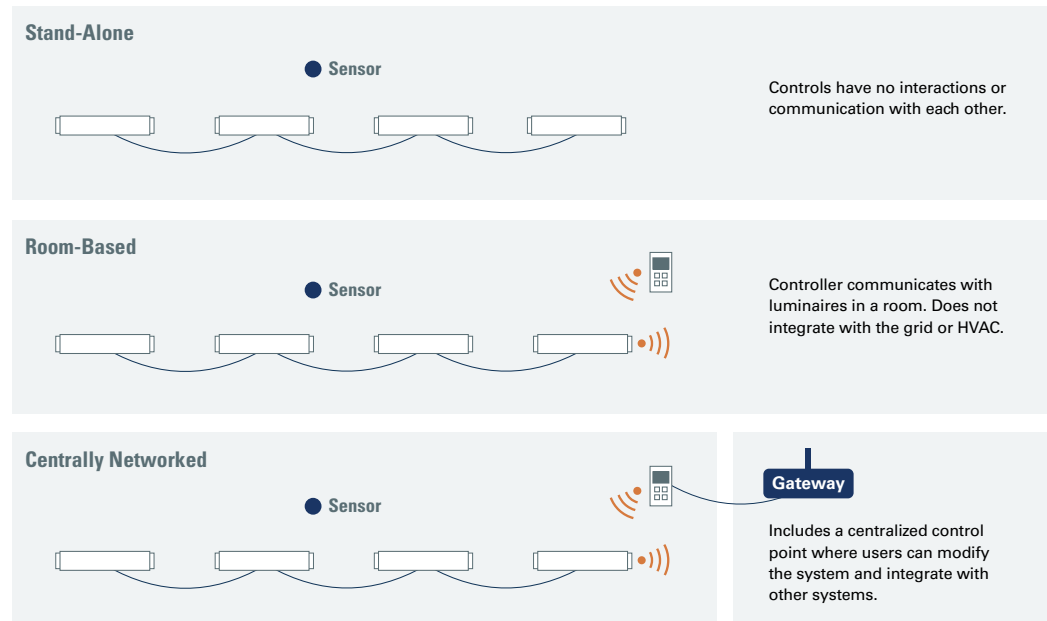

**Table 9**  
Stand-Alone vs. Room-Based vs. Centrally Networked

Feature	Stand-Alone	Room-Based	Centrally Networked
# of Luminaires	1 luminaire to a single room	3 or 4 zones in a room; limited by the size of the circuit powering it	Multiple luminaires, multiple rooms, even multiple buildings
# of Control Strategies	1 or 2	1-3	1-5 or more
Installed Cost	< \$1/ft <sup>2</sup>	< \$1/ft <sup>2</sup>	\$3/ft <sup>2</sup>
Demand Reduction	No	No	Yes
BAS and/or HVAC Integration	No	No	Yes
Allows for Expansion	In limited applications	Yes	Yes
Cybersecurity Risk	None to low	None to low	Medium to high

Stand-alone system architectures do not have a separate controller, and they do not communicate or interact with other systems. Stand-alone systems could be a corridor of luminaires controlled by an occupancy sensor or a row of lights along a window controlled by a single daylight sensor.

## Deployment Guidance

**Consider for low occupancy and transitory spaces,** such as restrooms, mechanical rooms, corridors, and stairwells.

**Also consider for enclosed spaces like private offices.**

## Implementation Considerations

**Stand-alone systems are typically cheaper** in design, materials, installation labor, commissioning, and even operations than networked control systems.

**Less complex and easier to modify or change.**

**Allow for easy visual tracking of installation issues** when they are wired directly to the luminaires.

**Additional energy savings and other benefits are limited** because stand-alone systems don't communicate beyond the directly connected luminaires and control points.

**A wall-mounted vacancy sensor** (manual on/off with automatic off sensor if occupant forgets to turn off the lights) that is wired to the fixtures can meet code requirements and be cost effective. A daylight sensor can be integrated into this configuration, if needed.

**Do not require firmware upgrades.** GSA has had challenges with upgrading the firmware in some networked systems post-occupancy.

**Material cost:** \$50–\$75 per sensor plus conduit and wiring.

**Labor time:** ~1/2 hour per sensor for installation and 1/4–1/2 hour per sensor for commissioning.

**Figure 13**

Wired and Wireless Stand-Alone Control Systems

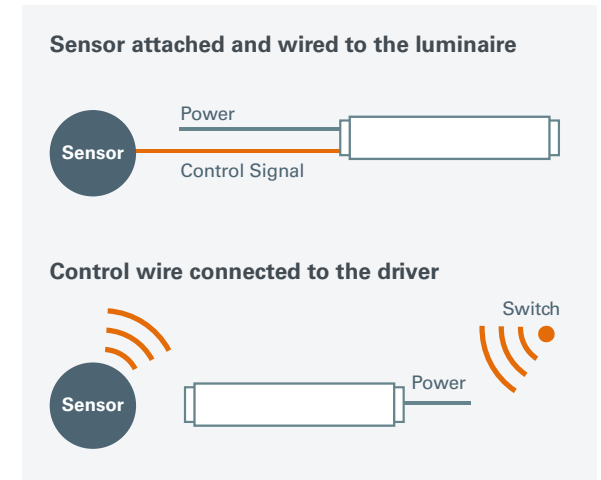

Room-based system architecture includes a controller that communicates with the luminaires through a wired or wireless signal. They do not communicate beyond the room, and they do not connect with the grid or HVAC systems.

## Deployment Guidance

**Consider in spaces where more than five people will be at the same time and no system integration is needed** (e.g., courtrooms, open offices, public atrium/lobbies, large classrooms, meeting/training spaces, and large conference rooms).

## Implementation Considerations

**Modular;** therefore, multiple controllers can be used in the same room if necessary.

**Can be extended in the future** by upgrading to a centrally networked lighting control system.

**Require a system that allows for commissioning,** programming, or reprogramming by off-the-shelf common devices like a mobile phone, tablet, or laptop.

**Provides scene control.**

**Does not have energy use information** or recording features.

**Consider communication protocols carefully.**

Digital control can provide consistency in dimming and color that is not supported by analog control.

**Figure 14**  
Room-Based Control System (Pacific Northwest National Laboratory)

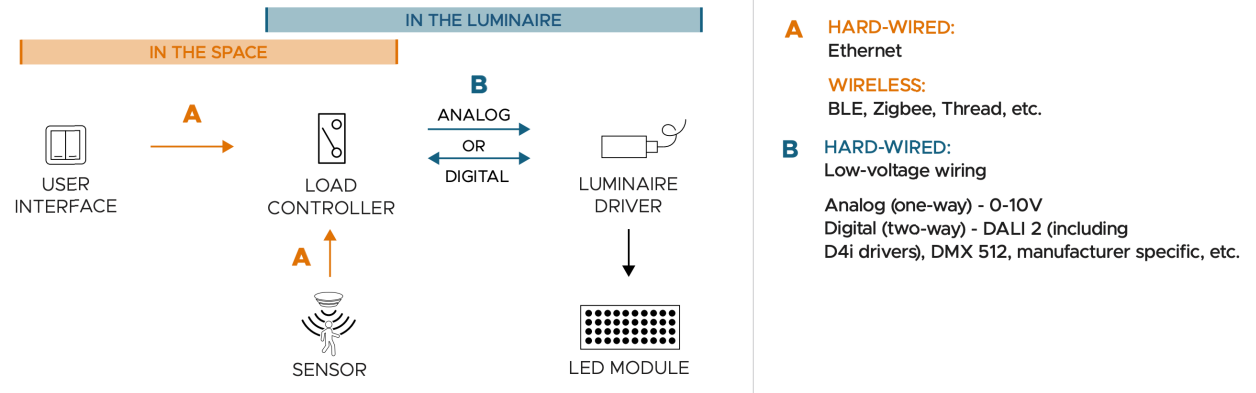

**Determine the number of zones during design** because zones can't be added after installation without an additional controller. For example, the zone controller has two parts: a relay for switching power on/off and a node for the wiring control signal.

**For simple solutions, room-based controls may be a great option.** During a GPG technology evaluation (GPG-037, [Advanced Lighting Controls and LED](#)) at the Fort Worth Federal Center in Fort Worth, TX, multiple stand-alone controls were tested and set up in a single building. The controls have been in place for years now, and the O&M and tenants use them regularly to perform simple tasks like dimming fixtures, checking for burnouts, and zoning office space.

**Specify a room-based module that can accommodate at least 20 amps of load.** Branch circuits are rated for up to 20 amps, which can be supplied to the module. If the load in the room exceeds this amount, additional controllers may be necessary.

**Material Cost:** \$1,000–\$3,000 per controller, price will vary based on load size, number of zones, and features.

**Labor Time:** 1–2 hours per room for installation of the room-based controller and commissioning of the daylight or occupancy sensors may require additional time; 1/2 hour commissioning per sensor.

# 4

## Select a System Architecture: Centrally Networked Control

Centrally networked control (i.e., connected lighting, networked lighting controls, advanced lighting controls, or “smart” lighting) includes a centralized control point where users can modify the system, integrate other systems, such as the BAS or HVAC, and monitor performance.

### Deployment Guidance

**Consider in spaces where more than five people will be at the same time** and you can integrate with the HVAC or respond to demand charges.

**Buildings over 50,000 ft<sup>2</sup> are ideal.** It is difficult to justify the costs for buildings under 25,000 ft<sup>2</sup> because a fair amount of equipment is independent of building size.

**Figure 15**  
Centrally Networked Control System (Pacific Northwest National Laboratory)

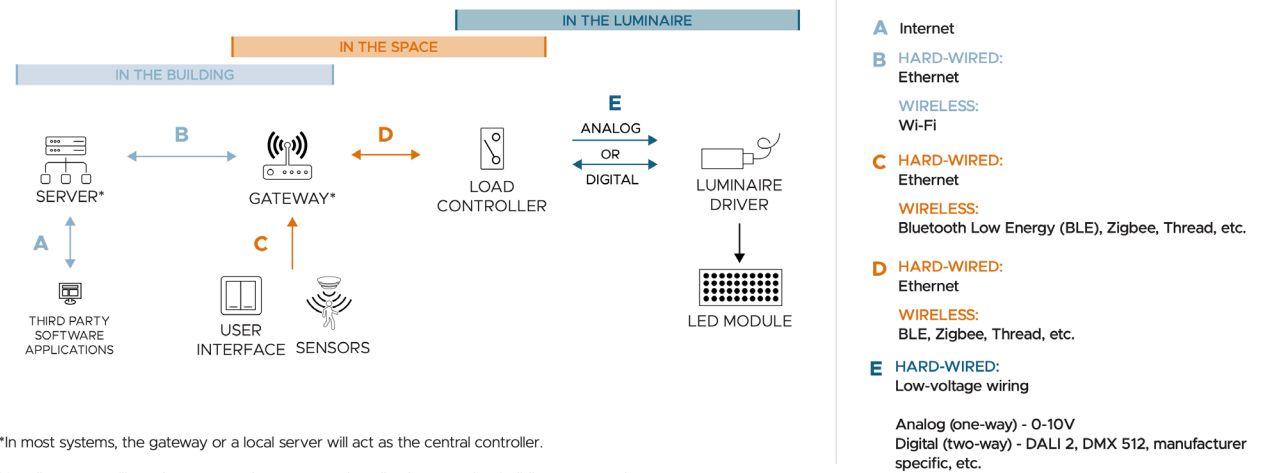

\*In most systems, the gateway or a local server will act as the central controller.

Not all systems will require a connection to external applications or other building systems via a gateway or server. In some systems, the load controller may be integral to the driver, the sensors, or the user interfaces.



### Questions for the Controls Vendor

- Does the interface require an on-site computer?
- Does the interface support remote internet access?
- Does the interface include a mobile app?
- Is there a limit to the number of users?
- How are settings modified?
- Who can modify the settings?
- Is a maintenance contract with your company necessary?
- How are firmware updates passed to the device? Is near-field communication an option?
- What devices will require a firmware update?
- Can you provide a room schedule with device locations?

## Implementation Considerations

### Allow for centralized control and commissioning.

In stand-alone systems, electricians or commissioning agents have to go to each control device to modify them. In contrast, in a centralized system, a user can change the schedule, dimming, or other settings all from a single location.

**Centralized systems are more complex than stand-alone controls** and require specialized training.

**Require and plan for firmware updates.** Depending on the system design, each component (e.g., all the switches in each room and sensors) may need to be updated. Firmware updates can take 10 to 45 minutes per device.

**Requires digital drivers**, such as DALI-2. Will not work with 0–10V drivers.

**Require greater cybersecurity scrutiny** than a room-based system.

**Include power failure protection** and continue to work even when the network may stop working for up to 48 hours.

**Bids can be higher than warranted** because the perceived complexity of networked systems can be greater than the actual complexity.

**Controlling the lighting system with the BAS can be easier than using a proprietary system.** In one GSA facility, staff had to request support from the lighting control vendor to make any changes. The lighting control system was ultimately connected to and is now controlled by the building automation system (BAS), which has been particularly helpful for building-wide control and maintaining consistent holiday schedules.

**Ensure adequate time for commissioning** the system after it is installed. Networked systems make it easy to adjust light levels but require someone knowledgeable of light level specifications and control system operation. Region 1 found that with proper commissioning, they were able to save an additional ~\$80K annually at one facility by updating system time clock subroutines, task tuning, and reducing light levels.

**Can compensate for overlighting.** By design, all lighting projects are overlit. Lamps depreciate over time, so initial light levels are higher. In instances without networked control, GSA has seen examples of tenants putting cardboard over their desks or sheets over the lights to address this problem.

**Evaluate control system programming** during product selection, and require staff training on how to program the selected system.

**Ensure proper commissioning after building upgrades.** In one GSA facility, during a building information technology (IT) systems upgrade, network addresses were reset, and the building required reprogramming, during which time the lighting control system was improperly commissioned.

**Avoid operating in “island” mode**, where the equipment is used on-site but the internet protocols are not set up for the system to communicate outside the building. At one GSA facility that operated in island mode, the systems stopped functioning because the firmware was not being updated. At another GSA facility, software features couldn’t function in island mode as the manufacturer had designed.

**Material Cost:** \$2–\$3/ft<sup>2</sup> for controls and related equipment (e.g., sensors, gateways, nodes, control interface, possible subscription)

**Labor Time:** \$1–\$2/ft<sup>2</sup> varies between wired and wireless and other site- and design-specific aspects

**Table 10**  
Luminaire Performance Diagnostics

	Driver	Light Source
<b>Performance Data</b>	<ul style="list-style-type: none"> <li>External supply voltage</li> <li>External supply frequency</li> <li>Power factor</li> <li>Temperature</li> <li>Driver output current %</li> </ul>	<ul style="list-style-type: none"> <li>Voltage</li> <li>Current</li> <li>Temperature</li> </ul>
<b>Failure Flags</b>	<ul style="list-style-type: none"> <li>Overall failure</li> <li>External supply under voltage</li> <li>External supply over voltage</li> <li>Output power limitation</li> <li>Thermal derating</li> <li>Thermal shutdown</li> </ul>	<ul style="list-style-type: none"> <li>Overall failure</li> <li>Open circuit</li> <li>Short circuit</li> <li>Thermal derating</li> <li>Thermal shutdown</li> </ul>
<b>Failure Counters</b>	<ul style="list-style-type: none"> <li>Overall failure counter</li> <li>Supply under voltage counter</li> <li>Supply over voltage counter</li> <li>Output power limitation counter</li> <li>Thermal derating counter</li> <li>Thermal shutdown counter</li> </ul>	<ul style="list-style-type: none"> <li>Overall failure counter</li> <li>Open circuit counter</li> <li>Short circuit counter</li> <li>Thermal derating counter</li> <li>Thermal shutdown counter</li> </ul>

After configuring lighting zones, determine sensor and controller locations.

LLLC systems include sensors embedded in the luminaire. An LLLC design will provide more granular design than a zone-based control design and is a better choice if you're seeking control features beyond those that meet minimum energy codes. Luminaire-based sensors are easier to configure than zone-based sensors.

In a zone-based lighting system, a sensor is located amongst a group of luminaires. The sensor will need to be wired to control the luminaires or be wireless; both can add additional labor costs. Zone-based control is less sensitive than LLLC because it controls a group of luminaires.

Troffers, strips, linear pendants, and high-bay spaces usually can accommodate sensors within the fixture. Downlights, sconces, cove luminaires, and other decorative fixtures usually cannot.



## Federal Agency IT Security

All lighting hardware goes through a remediation process, whether it's networked or not.

- Networked lighting systems go through an additional IT security process to determine how the system gets connected to the building. There are many ways lighting controls may be networked (e.g., BAS connection, cellular modem, wireless internal controls, cloud management, stand-alone), and every building is different.
- If there is a cloud-based component, it will need Federal Risk and Authorization Management Program (FedRAMP) approval.

For GSA, see *GSA's Building Technologies Technical Reference Guide* for information on integrating building management systems, including lighting control systems, into the GSA network. The GSA Building Technology Services Division can provide a list of lighting controls that have been remediated. They can also help determine the best way to set up the lighting control in a safe and secure manner.

LLLC systems have embedded sensors and controllers to make each luminaire an individual, autonomous control point. Greater granularity can allow for more energy savings and larger coverage of the space. LLLC fixture control can be either room-based or centrally networked.

## Deployment Guidance

**Consider for spaces that require more than five sensors.** LLLC can be less expensive than multiple independent sensors.

**Consider for spaces that have daylight or variable occupancy.**

**Required for HVAC integration and other enhanced lighting capabilities.**

**Avoid in call centers, security rooms, and sensitive compartmented information facilities** not because of a security concern, but because these spaces tend to be in interiors of buildings with little to no daylight and occupancy is semi-fixed.

## Implementation Considerations

**Sensors can be used for non-lighting applications,** such as integrating the lighting with the mechanical system or advanced features like space utilization.

**Increases the number of sensors in the space,** and thus, the total cost of the sensors.

**More sensors mean that each sensor has to be commissioned,** about 30 minutes per luminaire.

**Luminaire location determines the sensor locations,** which may not be ideal.

**Eliminates the need for separate sensor installation and power.**

**You may need to locate a few additional sensors outside the luminaires** because either the luminaire cannot support it or the area is not covered by the luminaire.

**LLLCs are easier to commission than LEDs with separate control systems.** During a GPG technology evaluation ([GPG-024, LED Fixtures with Integrated Advanced Lighting Controls](#)), staff found that compared to LEDs with separate control systems, the LLLC required minimal setup. After the manufacturer programmed a few sample zones, building staff and contractors were able to program the rest.

**Commissioning may need to be adjusted.**

Although manufacturers have made it easier to group commission sensors, it is not always perfect. For instance at GSA's John C. Kluczynski (JCK) Federal Building in Chicago, several luminaire sensors were controlling too large of an area and had to be adjusted.

**Beyond commissioning the sensors, sensor layout is also essential.** The sensors for the JCK installation were all placed on the "south end" of the luminaire. As a result, a handful of fixtures had sensors over cabinets in a kitchenette and had to be rotated 180 degrees.

**Material cost:** \$50–\$150 per sensor (sensor may include daylight, occupancy, and radio). If part of a networked system, gateways and other ancillary components will be required.

**Figure 16**  
LLLC Systems Embed Sensors in Individual Fixtures



**Labor time:** Zero hours for installation (sensors are installed in the luminaire at the factory); 1/2 hour commissioning per sensor.

**Digital zoning:** If the space changes or the design needs to be revised, sensors or luminaires can be reassigned (or re-zoned) via the lighting control system software.

**Granular data:** LLLC systems include more sensors in a space; this granularity provides greater coverage. Because LLLC systems are digital, the granular sensor data can be collected but operate as part of a larger system as appropriate.

In zone-based control, an occupancy or daylight sensor is mounted external to the luminaire(s).

## Deployment Guidance

**Private offices.** From an energy code requirement, private offices can easily be a zone-based lighting control scheme. However, there may be other benefits or reasons not to consider a zone-based design.

**Spaces that need fewer than five sensors.** When the number of combined lighting sensors (daylight and occupancy) exceeds five, a luminaire-level lighting control system will require less labor and coordination and will be easier to install and commission.

**Low occupancy/high transitory spaces.** Restrooms, storage rooms, stairwells, and corridors are good candidate spaces. Enhanced capabilities are usually not needed in these spaces, and the physical space layout encourages zone-based controls.

## Implementation Considerations

**Zone-based control requires more labor to install than an LLLC system.**

**Wired communication is most common.** Low-voltage wires connect directly between the sensor and the luminaire.

**Wireless sensors can be used.** Typically, the sensors communicate with a switch/device on the wall that is wired directly to luminaire(s) to dim or turn off lights.

**LLLC systems may require some zone-based configurations.** The JCK building in Chicago used luminaire-level lighting controls for space utilization and mechanical integration. However, some communal spaces did not have luminaires with sensors, and zone-based sensors were deployed in those areas.

**Material cost:** \$150 per sensor; low-voltage communication wiring will be added depending on location and configuration.

**Labor time:** Assume 1 hour for installation and commissioning per sensor.

**Figure 17**

Sensors are Mounted External to Luminaires in Zone-Based Control





Systems can be wired, wireless, or a combination. The term “wireless” is broad, and may encompass multiple communication protocols, and typically, only refers to a portion or portions of the system.

## Wired Controls

Wired controls use a physical connection (i.e., a low-voltage communication wire) between the luminaire and sensors or devices. Wiring topologies, such as bus, star, tree, and line will dictate equipment layout. Wired controls significantly increase the cost of retrofitting or moving parts of the control system.

## Wireless Controls

Wireless controls use a wireless signal between the device and luminaires. Many wireless signals exist, but Zigbee is the most common protocol used by GSA. Some wireless systems may use multiple communication protocols with a central gateway. Wireless control allows for flexibility in equipment layout and can be ideal for retrofits where construction materials may not allow physically running wires, especially in historic structures.

Wireless indicates how the data is communicated but does not mean the device is entirely wireless. Some wireless equipment is powered by a battery, which typically has a 10-year life and will need to be replaced. Other wireless equipment requires a physical power source. Inquire about power needs when considering a wireless system.

**Figure 18**

System Architecture with Wiring Controls (Pacific Northwest National Laboratory)

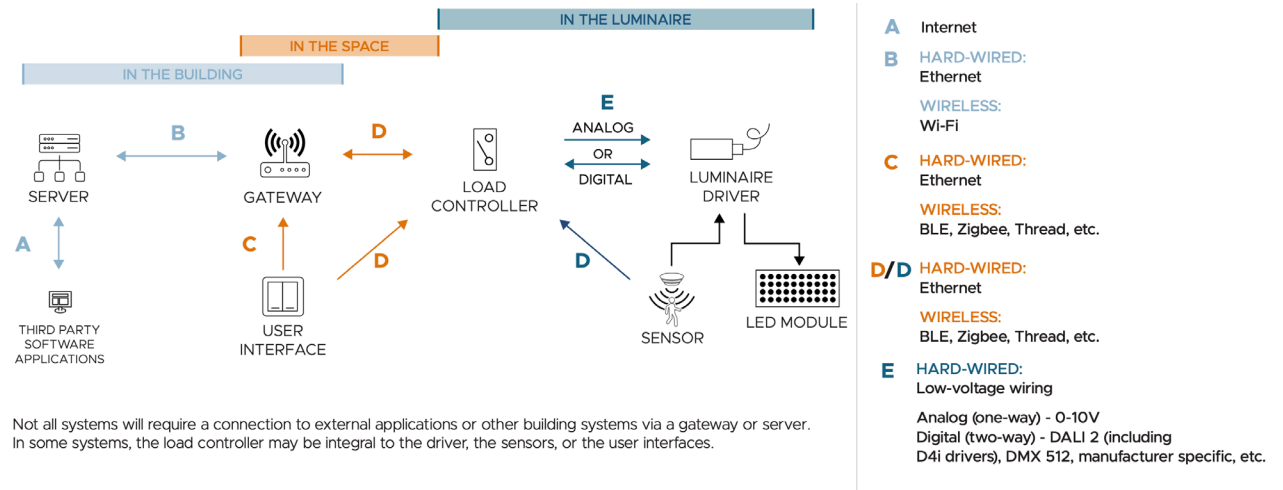

**Table 11**

Wired vs. Wireless Control Features

Feature	Wired	Wireless
Construction type	Primarily new	New or retrofit
Allowed per PBS-P100	Yes	Yes
Stand-alone controls	Hardwired to sensor	Wireless (non-WiFi) occupancy sensor options exist
Possible limitations	Will need to be rewired as space changes	Signals can be reduced by some building materials
Cost	<b>Labor:</b> More labor time and materials for running wires <b>IT:</b> Shorter cyber scan period <b>Materials:</b> lighting, controls, wires, conduit – \$5/ft <sup>2</sup>	<b>Labor:</b> Short labor time, just place nodes and gateways <b>IT:</b> Longer cyber scan period <b>Materials:</b> lighting, controls, beacon, gateway – \$4/ft <sup>2</sup>
Integrates with BAS	Possible	Possible



## Hub

In a hub, star, or spoke topology, a central access point sends and receives signals from other nodes, which do not communicate with each other. For a wireless system, install the hub in a location that will provide radio frequency (RF) coverage for all the devices communicating with it. For a wired system, locate the hub in a location that minimizes wire runs or wire run challenges. In some cases, luminaire controllers can act as boosters or repeaters to extend signal strength. Providing more hubs may increase communication speed and reliability but will also increase the cost.



## Mesh

In wireless mesh networks, all devices communicate with each other, and redundant paths exist to sustain communication when a single device fails. A mesh network can improve system resilience, increase the signal strength shared between devices, and increase the expanse of the network. Mesh networks can exist without a gateway if a connection to a central server, external building systems, or applications is not needed.

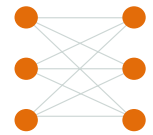

## Point-to-Point

Unlike hub and mesh networks, point-to-point network signals are typically limited to a single space. Point-to-point connections are often used within larger systems for communication between components or to incorporate battery-powered devices (e.g., audio/visual controls, local controls).



## Bus

Bus-wired networks can span a space or a building. All devices in the network are connected by one central network cable. This central cable is the “bus” and each device connects back to the bus.

The lighting communication protocol refers to the type of driver and how devices communicate with the driver. The two most common protocols are 0–10V and DALI. Both analog and digital systems can be controlled wirelessly.

## Analog

Analog control (e.g., 0–10V) dims lights in response to voltage. Analog control is less precise and flexible than digital control. Control zones are determined by wiring, and changing zones requires rerouting the wires, which can be quite costly. Because 0–10V is a low-voltage signal where the specific voltage corresponds to an output, maintaining the signal voltage is key. The distance and number of fixtures that can belong to a zone are limited before the voltage drops.

Some advanced capabilities are not compatible with 0–10V luminaires but can be successfully implemented with a digital load converter.

## Digital

Digital control (e.g., DALI-2) provides a two-way transfer of information, which enables system feedback and reporting. With digital control, when different fixture types are grouped together, they will all dim the same. DALI-2 is ideal for open-space environments. When cubicle and workspace layouts change, the lighting can be regrouped and adjusted as needed.

**Table 12**  
Analog vs. Digital Communication Protocols

Feature	Analog (0–10V)	Digital (DALI-2)
<b>Data Exchange</b>	<ul style="list-style-type: none"> <li>One-way</li> </ul>	<ul style="list-style-type: none"> <li>Two-way</li> </ul>
<b>Luminaire Addressability</b>	<ul style="list-style-type: none"> <li>No</li> </ul>	<ul style="list-style-type: none"> <li>Yes</li> <li>Enables advanced features such as reporting run time, energy use, and failures</li> </ul>
<b>Zoning Flexibility</b>	<ul style="list-style-type: none"> <li>Determined by wiring</li> </ul>	<ul style="list-style-type: none"> <li>Can be reconfigured in software</li> </ul>
<b>Dimming Precision</b>	<ul style="list-style-type: none"> <li>Inconsistent dimming output between products. Some 0–10V drivers have a maximum output of 90%.</li> <li>No standardized luminaire response signal. One luminaire may dim to 60% at 7V and another may dim to 80% at 7V.</li> </ul>	<ul style="list-style-type: none"> <li>Consistent logarithmic dimming, matching the eye's sensitivity</li> <li>Standardized response signal. Different fixture types respond the same.</li> </ul>
<b>Cybersecurity Risk</b>	<ul style="list-style-type: none"> <li>None to low</li> </ul>	<ul style="list-style-type: none"> <li>None to low</li> <li>If a 0–10V lighting system has already passed cyber security clearance, it should be a small add-on to have a digital driver remediated.</li> </ul>
<b>Availability</b>	<ul style="list-style-type: none"> <li>Widely available with greater familiarity</li> </ul>	<ul style="list-style-type: none"> <li>Most manufacturers have at least two DALI-2 options</li> </ul>

**Figure 19**  
Digital Control is Less Expensive for Multiple Lights / Zones\*

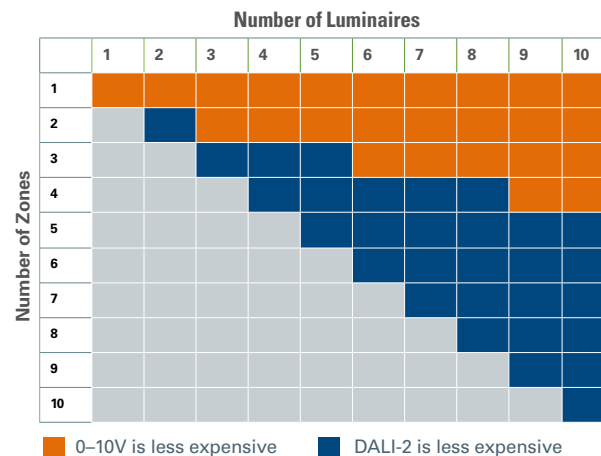

\*0–10V can be more expensive than DALI-2 because of the need for additional wire, conduit, output devices, and adjustments in the field.

**Figure 20**  
Configuration for 0–10V or DALI-2 LED Drivers

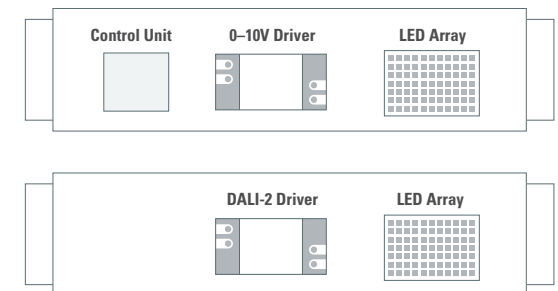

## Digital Addressability

Digital control enables addressability so each luminaire has a unique identifier that allows for individual control and luminaire information. It's helpful if "as-built" documents include luminaire individual addresses.

**Figure 21**  
Reflected Ceiling Plan of an Open Office

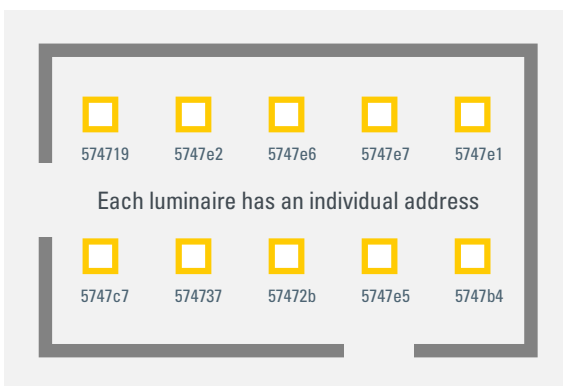

## DALI-2 is Interoperable

DALI-2 is an open protocol and requires testing and verification of compliance for all control devices. DALI version-1 (or DALI-1) systems included proprietary devices and the driver was not certified. The newer version DALI-2, was established in 2017. As of December 2023, the [DALI Alliance product database](#) lists over 4,000 certified products (e.g., drivers, sensors).

As early adopters, GSA experienced multiple issues with DALI-1 proprietary and non-certified controls. Systems using DALI-2 should not experience these problems.

**Table 13**  
Control Strategies and Addressability Needs

Control Strategy	Need for Digital Addressability
<b>Scheduling</b>	No to low need.
<b>Occupancy</b>	Low to medium need. May allow the building to change the sensor or fixtures remotely. If using advanced features like space utilization, you need addressability.
<b>Daylight-Responsive Control</b>	Medium need. May make commissioning easier.
<b>Task Tuning</b>	Medium to high need. Allows individual luminaires to have different output levels.
<b>Diagnostics</b>	Essential. Diagnostics include hours of operation, voltage, and other factors of the luminaire.

**Table 14**  
DALI-1 vs. DALI-2

	DALI-1 2002–2017	DALI-2 2017–
<b>Includes control gear (e.g., LED drivers)?</b>	X	X
<b>Includes control devices (e.g., input devices, application controllers) and other devices?</b>		X
<b>Test sequences designed to ensure product interoperability?</b>		X
<b>Test results verified by the DALI Alliance?</b>		X

Lighting systems need to be updated regularly to accommodate firmware and system feature updates and building changes and to ensure that lighting operates most efficiently. Retro-commissioning (RCx) and re-commissioning are basically the same procedure, but the term retro-commissioning is used when the building was not properly commissioned in the first place and re-commissioning is used when the building has been commissioned previously. Therefore the process tends to be faster and simpler.

Re-commissioning may be needed after a renovation alters surface finishes, which may change reflectances; when a building performance contract switches to a new vendor; when new tenants take over a space; or after a lighting control system has been updated with new features. Retro-commissioning seeks to improve lighting system performance.

Commissioning (Cx) has been studied more for HVAC than lighting. HVAC studies, detailed in the [Improving Energy Efficiency Through Commissioning](#) guide, have found that retro-commissioning existing buildings can provide 10% to 30% energy savings.

## Implementation Considerations

**Avoid operating in “island” mode**, where the equipment is used on-site but the internet protocols are not set up for the system to communicate outside the building. At one GSA facility that operated in island mode, the systems stopped functioning because the firmware was not being updated. At another GSA facility, software features couldn’t function in island mode as the manufacturer had designed.

**Develop a maintenance schedule.** Routinely (every 6 months) verify with the manufacturer of the control system if any updates exist for the lighting control system.

**Plan for firmware and other updates.** Depending on the system design, each component (e.g., all the switches in each room and sensors) may need to be updated. Firmware updates can take 10 to 45 minutes per device.

**Recommission the space.** Many jurisdictions and building programs require that operators must retro-commission their mechanical system every 2 to 5 years—lighting is no different. Plan to recommission the building every 2 to 5 years. Determine what has changed since the original commissioning or last commissioning. Determine if sensor timeout periods or daylight settings need to be adjusted.



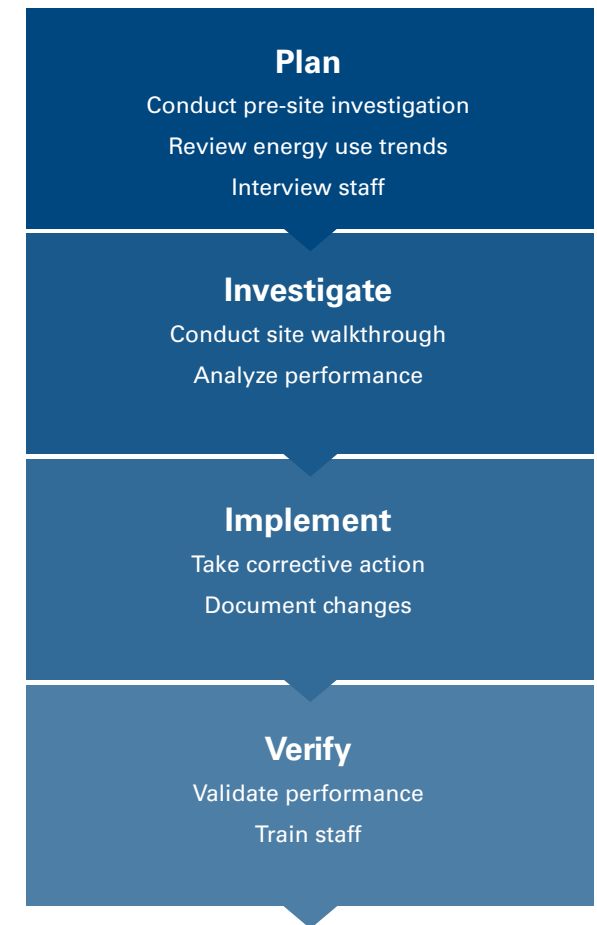

**Figure 22**  
Retro- and Re-Commissioning Steps



# Energy-Saving Capabilities

Lighting controls vary the light in a space by automatically turning lights on/off or changing light levels in response to occupancy, daylight, or other factors. Luminaire sensors can be integrated with other systems, such as HVAC, for additional savings. Savings will be similar whether the controls are stand-alone, room-based, or centrally networked. However, networked lighting controls yield slightly greater savings because those systems can be more granular.

**Table 15**  
Lighting Control Energy-Saving Strategies

Control Strategy	Lighting Savings					Integrated System Savings	
	Scheduling	Occupancy Sensing	Dimming	Daylight-Responsive Control	Task Tuning	Demand Response	HVAC Integration
							
<b>Typical Energy Savings<sup>1</sup></b>	40% lighting if lights are on 24/7	24% lighting <sup>2</sup>	20% (will depend on your preference)	28% lighting <sup>3</sup>	20%+ lighting <sup>4</sup>	20% kW reduction (not energy) <sup>5</sup>	30% HVAC <sup>6</sup>
<b>Code Compliance</b>	GSA PBS-P100 ASHRAE/IES 90.1	GSA PBS-P100 ASHRAE/IES 90.1	GSA PBS-P100 ASHRAE/IES 90.1	GSA PBS-P100 ASHRAE/IES 90.1	—	Supports GSA's GEB initiative	Unoccupied setpoints will be required in ASHRAE/IES 90.1 2022
<b>Minimum System Requirements</b>	Scheduler with astronomic and time- and day-based functions	Occupancy sensors	LED naturally dims	Daylight sensors	Digital communication protocol  Centrally networked system	Digital communication protocol  Centrally networked system	Digital communication protocol  Centrally networked system

<sup>1</sup> Savings are not additive as shown on the next page.

<sup>2</sup> *Lighting Controls in Commercial Buildings*. Leukos. Jan. 2012. Occupancy savings from GPG evaluations have ranged between 12% and 63%.

<sup>3</sup> *Ibid.* Daylight savings from GPG evaluations have ranged between 7% and 27%.

<sup>4</sup> *Ibid.* Task tuning savings from GPG evaluations have ranged between 6% and 24%. Task tuning more than 30% is not recommended.

<sup>5</sup> Demand response programs typically require a 20% reduction (CA Title 24 2019). Occupants have found 40% dimming acceptable with no or low daylight, and 80% with high prevailing daylight.

<sup>6</sup> *Detection and Acceptance of Demand-Responsive Lighting in Offices with and without Daylight*. Leukos. Jan. 2008.

<sup>6</sup> *Lighting System Integration with HVAC and Plug Loads: Tinker Air Force Base*. Jan. 2021.

# Combining Lighting Savings

Beyond the individual control strategy savings, it is important to understand the interrelation of energy savings from controls. Energy-saving measures are not additive. Two measures that may each save 25% do not save 50% when combined but rather a nominal 44%.

Even though controls offer significant savings, it can be challenging to realize a positive ROI because LED lighting is so efficient. GSA is required to comply with ASHRAE/IES Standard 90.1, which includes the need for occupancy and daylight sensors.

Calculate ROI with our advanced lighting controls payback calculator.

[Download Payback Calculator](#) ↓

**Table 16**  
Energy Savings for Individual/Combined Strategies (% saved = ES1 + ES2 - ES1 × ES2)

Individual Savings				Combined Savings		
LED (ES1)	Tuning (ES2)	Occupancy (ES3)	Daylighting (ES4)	LED + Tuning	LED + Tuning + Occupancy	LED + Tuning + Occupancy + Daylighting
10%	20%	24%	28%	28%	45%	61%
20%	20%	24%	28%	36%	51%	65%
30%	20%	24%	28%	44%	57%	69%
40%	20%	24%	28%	52%	64%	74%
50%	20%	24%	28%	60%	70%	78%
60%	20%	24%	28%	68%	76%	82%
70%	20%	24%	28%	76%	82%	87%
80%	20%	24%	28%	84%	88%	91%

**Figure 23**  
Diminishing Returns for Combined Energy Savings (highlighted in Table 16)

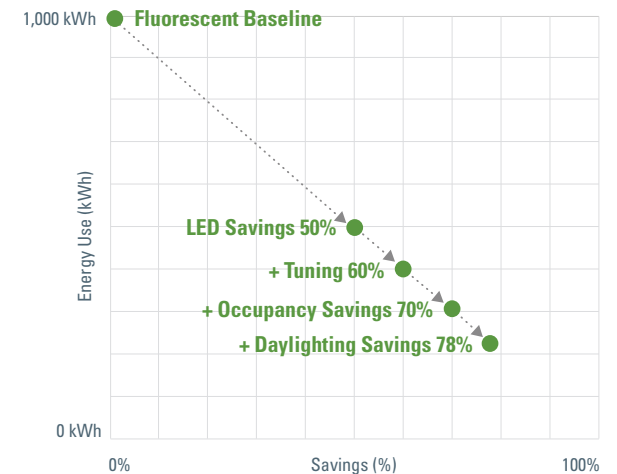

# Scheduling

Scheduling is used for areas of predictable occupancy, in which a control system dims, activates, or shuts off a lighting system on a predetermined schedule. Scheduling is one of the weaker forms of control because schedules are often longer than necessary because building managers don't want the lighting to turn off while occupants are still in the space.

## Deployment Guidance

**Code compliance requires either occupancy sensing, daylight sensing, or scheduling** and dictates which of these control capabilities to use.

**Atria, public spaces, and exterior lighting are good spaces for scheduling.**

## Implementation Considerations

**Scheduling tends to apply to large zones.** Spaces with multiple and small zones are not ideal for scheduling-based controls.

**Be selective when choosing locations for overrides.** If an open office is scheduled to turn off, include an override near the entrance to the space.

**Occupants should turn on lighting rather than relying on a scheduled time.**

**Energy savings will be greater for occupancy sensing** than for schedule-based controls for many interior applications.

**In exterior lighting, switching from timers to daylight sensors can save significant energy** and time for making adjustments.

**Limit the use of spaces being controlled by scheduled-based controls.** Buildings can have a mixture of controls in different spaces. A corridor may be controlled by an occupancy sensor, and a lobby may be controlled by schedule.

**Networked lighting controls have large memories and can have multiple schedules** (e.g., day of week, seasons, and possibly for holidays).

**Specify a lighting control system with a relay system.** The relay assists with the override functions. Before the schedule turns off the lighting, it can blink the lights, and users can push the "override button" to extend the time before the schedule turns off the lights.

**Require both astronomic functions and time- and day-based functions** for the schedule.

**Material cost:** < \$1,000 for the scheduling feature or time clock.

**Labor time:** 30–60 minutes to set up scheduling.



## Timer Switches

A timer switch is different from scheduling. The switch is contained within the wallbox and turns off the lighting after a period of time (e.g., 4 hours) if an occupant leaves and forgets to turn it off manually.

- **Timer switches are easy to access and typically used in closets and small storage.**
- **Low-cost and low-quality time switches may lose memory in the event of a power failure.** The lighting industry is raising this as an issue, and some manufacturers are developing better systems to prevent this from occurring.



# Occupancy Sensing

Occupancy sensing (i.e., presence or motion detection) turns lights off and on in response to whether a space is occupied. Currently, most sensors are motion-based, but advanced sensors are being developed for presence and occupancy detection.

## Deployment Guidance

**Occupancy sensing is mandated by energy codes** for most interior spaces.

**Determine which sensor type works best** for your space.

- **Passive-infrared (PIR) sensors:** Detect large movements and temperature changes in a space. PIR sensors are common in offices and conference rooms but don't work if there is an obstruction.
- **Ultrasonic sensors:** Emit a sound wave to detect movement based on the return time to the sensor. Ultrasonic sensors work best in spaces with walls or partitions (e.g., restrooms).
- **Hybrid sensors (dual PIR and ultrasonic):** Work best for applications where false-negative signals need to be avoided.
- **Other sensors:** Include microwave, Wi-Fi, and video-based, which are being explored but are less common for interior applications with lighting systems.

**Consider vacancy sensors in smaller spaces** (e.g., private offices, conference rooms). If the occupant forgets to turn off the lighting, the vacancy sensor automatically turns it off.

**Regularly test occupancy sensors in parking garages and stairwells as safety and security concerns arise.** Occupancy sensors in these areas can save significant energy and increase the perception of safety.

- In parking garages, occupancy sensors change the lighting in response to movement and help others determine movement in the space.
- Although stairwells are often unoccupied, don't turn off the lighting, but reduce to 20% or 30% output to address concerns related to safety if the sensor fails.

## Implementation Considerations

**Set a 10-minute time out in common office spaces.**

**Set a 5-minute time out in transitory spaces** (e.g., parking garages, stairs).

**Occupancy sensors can be integrated with other systems** and functions, such as security, mechanical, contact tracing, or space utilization.

**Buildings with long operating hours and variable occupancy patterns will have the best ROI.** ([GPG-002, Occupant Responsive Lighting](#))

**Consider tri-level sensors** in parking garages, stairs, and some corridors. The settings for a tri-level sensor are full output, reduced output, and off. Using two different reduced output settings is possible but will require a complex control system.

**Install more sensors for greater coverage to reduce false-negative signals** when the sensor does not detect a person in the space and turns off or reduces the lighting while the space is occupied.



Integral occupancy sensor in parking garage luminaire increases output when motion is detected.

Photo credit Akoya, U.S. DOE

**Table 17**

Range of Savings for Different Spaces from FEMP

Room Type	Occupancy Sensor Lighting Energy Savings*
Classroom	40%–46%
Conference Room	45%
Office, Private	13%–50%
Office, Open	10%
Restroom	30%–90%
Storage Area	45%–80%
Warehouse	35%–54%

\*FEMP *Wireless Occupancy Sensors for Lighting Controls: An Applications Guide for Federal Facility Managers*, December 2019.

# Occupancy Sensing

**Sensors that turn on lighting in occupants' field of view can result in negative feedback.** In open-plan offices, when an occupant re-enters their workspace, the lighting may increase just in their workspace, which can be visually jarring to other occupants. To minimize this sensation, consider using a luminaire with an uplight component or don't turn the lights off, but dim them down to 10% for a low glow.

**Privacy and personally identifiable information concerns arise with more advanced occupancy or presence detection.** Video sensors need to be able to differentiate a person from a ball or a pole but not capture or store information about the person. Radio frequency identification (RFID) tags on employee badges can also be used, but there may be privacy concerns with that application as well.

**Work with occupancy sensor manufacturers to determine the precise location of the sensors.** Consider furniture layout so that furniture does not obstruct the view of the sensor, sensitivity of the sensor, and sensor type.

**Energy savings from occupancy sensors is affected by sensor and space type.** Savings from space types is correlated with the vacancy of the spaces. A call or operations center will have low savings because the space is constantly occupied, whereas stairwells have high savings because they are not used often.

**Material cost:** Assume \$50 per sensor (video or other sensors may be more expensive).

**Labor time:** < 1 hour

**Table 18**  
Occupancy Detection Methods

Detection Type	Coverage	Function of Detection	Building Systems Controlled
Motion	Gross	Uses lack of motion as a proxy to determine if the area is empty	Lighting
Presence	Fine	Determines if a person is in the space	Lighting, plugs*, HVAC
Occupancy	Fine	Counts number of people in the area	Lighting, HVAC

\*Although lighting systems can control plug loads, it is not recommended.

**Table 19**  
Types of Occupancy Detection Sensors and Where They Are Recommended

Sensor Type	Private Office	Open Office	Corridors	Bathrooms (spaces with partitions)	Tall Spaces (gym, storage, warehouse)	Court	Exterior Applications
<b>Motion</b>							
PIR	X	X	X		X		X
<b>Presence</b>							
Ultrasonic		X					
Hybrid		X		X		X	
Microphonic		X					
Video							X
<b>Occupancy</b>							
RFID		X	X		X		
Microwave						X	X

# Dimming

With dimming, the light can be reduced from full output over a continuous range. Unlike fluorescent or HID lamps, LEDs dim very easily.

## Deployment Guidance

Consider for open-plan offices, private offices, and conference rooms.

Avoid in spaces with low or infrequent use, such as electrical and mechanical rooms, storage rooms, and security queue areas.

Dimming enables other control capabilities.

## Implementation Considerations

Requires a power supply that supports dimming.

It also needs a dimming signal, which will require more labor and materials than a switched system.

Equipment may flicker when dimmed. Test sample products of what will be installed for flicker by dimming them before installation or final specification. Flicker is a broad concept, and if there is a concern, reach out to designers or engineers who are knowledgeable about flicker (i.e., temporal light artifacts).

Require design documentation to include a schedule of the dimming methods of the lighting equipment.

LEDs dim using different methods (e.g., forward phase, reverse phase, pulse-width modulation). Documentation will limit issues related to design and commissioning.

LED drivers will need to dim/reduce the light output to at least 20% of the full output.

Some drivers can dim to 10%, 5%, and even 1% output. Light output below 20% will depend on the efficiency of the light engine and driver paired together. Lower dimming ranges are only necessary for select applications; in most applications, dimming to 20% of the full output is sufficient.

**Material cost:** Incorporated into the cost of the luminaire (no adder), but some control device is needed.

**Labor time/costs:** No costs for continuous dimming, but some commissioning may be necessary.

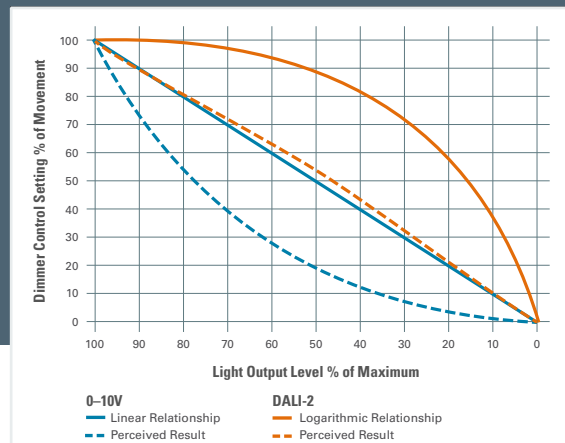

Figure 24 Perceived Light Output for 0-10V and DALI-2

The human eye does not perceive reductions in light in a linear fashion. For example, dimming to 50% of the measured light output will be perceived as 80% of the full light output. Dimming curves were established to address the eye's perception.

0-10V systems most often use a linear function for dimming. Moreover, there are no standardized dimming functions for 0-10V systems. In contrast, DALI uses a logarithmic function that mimics how the eye perceives changes in light output.

Table 20 Dimming Enables Other Control Capabilities

Control Capability	Need for Dimming
Scheduling	Not needed. Exterior requirement for a 50% reduction at midnight can be accomplished by turning off fixtures.
Occupancy	Low to medium need. Helps in certain applications (e.g., open plan) to dim smoothly rather than abruptly turn on/off.
Daylight	Medium to high need. Allows seamless lighting as electric output varies in response to daylight.
High-End Trim	Medium to high need. Allows the lighting to be set at the desired output rather than a discrete level not of the building manager's choice.
Personal Control/Tuning	High need. Allows the lighting to be set at the desired output rather than a discrete level not of the occupant's choice. Personal control/tuning is required in PBS-P100 for Tier 2 and 3 projects.

# Daylight-Responsive Control

Daylight-responsive control uses daylight to offset the amount of lighting needed in a space. The lighting control system dims or turns off the electric lighting in response to available daylight as determined by a photocell inside the daylight sensor. Daylight-responsive control is mandated by energy codes for many interior spaces.

## Deployment Guidance

**Mandated by energy codes for interior spaces with adequate daylight.**

**Best suited to:**

- Open-office areas
- South and west sides of buildings
- Buildings with steady occupancy; variable occupancy means most savings will come from occupancy sensors, which will limit savings from daylight.
- Older historic buildings. Buildings built before 1930, before electric lighting was common, were designed to follow the sun's path. Many contemporary buildings have not been designed to take advantage of daylight-responsive control.

## Implementation Considerations

**Assume one daylight sensor per private office** and at least one sensor per 30 linear feet in an open office.

**Consider a combination occupancy/daylight sensor** to reduce material and installation costs.

**Identify the sensor orientation** during the commissioning phase.

**When commissioning the daylight sensor, create a suitable deadband.** If the deadband is too sensitive to sky changes, such as fast-moving clouds, light dimming won't match outside conditions. One GSA facility experienced a 3-second delay with daylighting sensors, so lights dimmed when the sun was behind the clouds.

**Ensure the sensor can view daylight without obstructions** (e.g., fans, other fixtures, exposed ductwork, projectors).

**Increased savings from occupancy control can leave little room for daylighting** ([GPG-015, Integrated Daylighting System](#)).

**In exterior applications, the photocell can degrade** causing the lighting to stay on during daytime hours.

**For exterior lighting, use open-loop systems.** Daylight-responsive control can be designed as either an open or closed loop. Open-loop systems only measure the daylight outside the space, and a single sensor can control multiple zones. A closed-loop system measures both daylight and the electric light in the space. The sensor can be affected by surrounding materials (e.g., white paper on a desk) and is more complicated to set up.

**For zone-based interior applications, select open-loop systems.** Closed loops are more common for LLLC systems.

**Material cost:** ~\$50 per luminaire, zone-based control is \$300–\$400 for six luminaires.

**Labor time/costs:** Commissioning and wiring add to the costs. If using luminaire-level control, there will be more sensors.

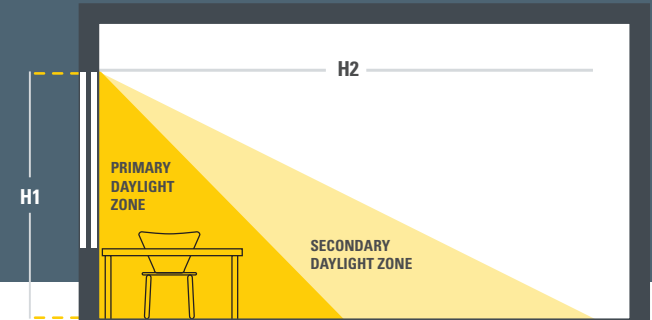

**Figure 25**  
Daylight-Responsive Control Zones

There are two zones within spaces where daylight can provide sufficient illumination:

- The primary zone (H1) is adjacent to the exterior window and is equal to the height of the window.
- The secondary zone (H2) is adjacent to the primary zone and also equal to the height of the window (H2).

# Task Tuning

Task tuning (i.e., high-end trim or institutional tuning) lowers maximum light output and can be set by a networked control system or a physical dip switch with predefined outputs. With a networked system, the maximum light output can be modified to meet occupant preferences or when spaces change. Dip switches are typically set during installation and not changed again.

## Deployment Guidance

**Consider for all sites because it helps with occupant satisfaction.** (GPG-037, [Advanced Lighting Controls and LED](#)). In particular, low-glare luminaires or systems that can be task-tuned should be specified in regularly occupied spaces, such as workspaces and courtrooms.

**Task tuning is well suited for facilities that want to use the same fixture throughout the building.** Dip switches can be a contractor advantage to reduce the burden of sourcing multiple products.

## Implementation Considerations

**Installing lights that are brighter than you need may seem counterintuitive,** but task tuning offers three advantages:

1. One fixture type can be installed across the project and adjusted per room as needed.
2. It enables flexibility to meet different occupant needs, increasing occupant satisfaction.
3. LED light output depreciates (~2% a year); tuning enables adjustments in the field so that the lighting output can be increased over time.

**Requires either networked lighting controls or a dip switch** with field adjustable features (e.g., power: 1200, 1800, 2400 lumens, and color)—not all luminaires or lamps have this option.

**Trim each zone based on the space and/or occupants** rather than assuming a global reduction for the whole building.

**Consider either different or lower output luminaires if you plan to trim the lighting by more than 30%.**

**Reducing the maximum light output can reduce glare** found in some LED fixtures.

**Delamping is not possible with LED fixtures,** so task tuning may be critical for occupant satisfaction. Previously, when fluorescent lighting was too bright, facility staff removed one or two of the lamps in a fixture. LED luminaires and retrofit kits do not have removable lamps.

**Task tuning can save money.** In a GPG technology evaluation (GPG-037, [Advanced Lighting Controls and LED](#)) of five different vendors at a Fort Worth, TX, facility, each of the networked lighting technologies was trimmed with an average savings of 22% (or 0.41 kWh/ft<sup>2</sup>). In one GSA facility in Region 1, staff found that with proper commissioning, they were able to save an additional ~\$80K annually by reducing light levels.



**Verify with the manufacturer if the lamp or luminaire was trimmed** because this can happen before or after the fixture leaves the factory.

**Document the designed light levels.** Wait at least two weeks after the new installation or retrofit before tuning. If tuning based on user preference, survey multiple occupants of the space about their preference.

**Specify a networked lighting control system** for maximum flexibility in tuning.

**Material cost:** 10–20% cost is added for fixtures; \$3/ft<sup>2</sup> for the control system.

**Labor time:** Labor is primarily for lighting controls installation and commissioning.

# HVAC Integration

HVAC integration uses occupancy sensors embedded in the lighting system to communicate with the BAS, which controls the HVAC system. The lighting system provides power to the occupancy sensors, so no additional wiring is necessary.

## Deployment Guidance

**HVAC integration is a good choice for networked lighting systems with LLLC** where many, if not all, of the light fixtures have a sensor.

**Energy codes are adopting “occupied-standby” requirements** (e.g., ASHRAE/IES Standard 90.1, California’s Title 24, and/or the International Energy Conservation Code) that require occupancy sensors to set back temperatures when spaces are unoccupied. Using the same sensors to control both lighting and HVAC reduces the number of sensors and simplifies installation.

### **Recommended for building over 50,000 ft<sup>2</sup>.**

Buildings over 25,000 ft<sup>2</sup> should be evaluated on a case-by-case basis. For buildings under 25,000 ft<sup>2</sup>, it’s difficult to recover some costs of integration at this time.

**Both new construction and retrofit buildings are ideal for integration.** Buildings with variable mechanical systems (e.g., Variable Air Volume systems) and reasonable thermal zoning should be considered. Buildings with large zones (e.g., Air Handling Units serving three or more floors that were common in the 1970s and 1980s) should be avoided unless the zones are smaller.

## Implementation Considerations

**Using the same sensors to control both lighting and HVAC improves cost recovery.** In a [PNNL analysis at the Tinker Air Force Base](#), payback was reduced from 12 to 7 years with HVAC integration. The [Life-Cycle Cost Effectiveness for Controls](#) analysis shows that HVAC integration increases the ROI of controls between 20% and 37%.

**No new mechanical equipment is needed.**

**Engage a system integrator or someone knowledgeable about both HVAC and lighting.**

Verifying integration is not straightforward and requires extensive data analysis and an understanding of the sequence of operations.

**Integrating the lighting with the mechanical system can provide significant financial benefits.** The [Office of Personnel Management](#) integrated a networked lighting control system with the building mechanical system and saved 1,000,000 kWh (\$94,000) in annual savings; or \$1.9/ft<sup>2</sup>.

**DOE case studies have demonstrated HVAC savings > 20%.** In a [PNNL study for the American Council for an Energy-Efficient Economy \(ACEEE\)](#), 83% of the mechanical system energy was saved because the building operated 24/7 but had dynamic occupancy.

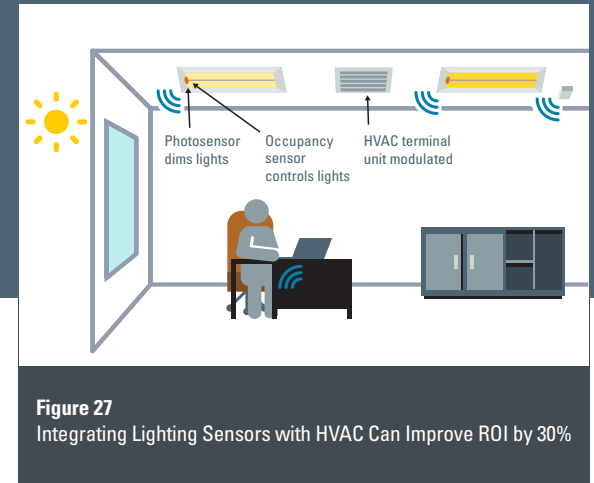

**At least once a year (twice recommended), confirm that the lighting system is communicating with the BAS and HVAC systems.** Small changes, such as a manual temperature override, can stop the systems from communicating with each other.

**Biannually check for updates** for the lighting control system so the system continues to operate. At one GSA facility, the systems stopped functioning because the firmware was not being regularly updated. If you fall behind on updates, new updates may not work with the older system.

**Determine protocol version compatibility** when investigating the interoperability of systems; for instance, some products claim to communicate with BACnet but may only be compatible with BACnet 10.

**Material cost:** < \$0.25/ft<sup>2</sup>

**Labor time:** < 50 hours of labor time for mapping thermal zones and lighting zones/sensors and logic for setbacks.

# Demand Response

Lighting, especially LEDs, can easily and quickly be dimmed, making it a good technology for load shedding in response to demand. Load shedding can be prioritized by either price or grid carbon intensity and can be part of a whole building GEB strategy to provide continuous demand management and load flexibility.

## Deployment Guidance

**Target locations with demand charges that exceed \$5/kW.**

**Demand response is best suited to open offices, courtrooms, and atriums** because these spaces are large and frequently occupied.

## Implementation Considerations

**A temporary reduction of 20% for load shedding is imperceptible to the eye.** This reduces the negative effect on occupants. Lighting can easily shed 0.12 W/ft<sup>2</sup>; buildings over 50,000 ft<sup>2</sup> can shed > 4 kW.

**Lighting can be dimmed in a matter of minutes,** unlike many other building loads that require more time to shed load properly.

**Because LEDs are so efficient, lighting loads are smaller.** Therefore, the available power to shed is lower than in other building systems. Although easier to shed load, lighting can be overlooked because the load is not the same size as other building loads.

**Daylight harvesting may minimize the impact of load shedding.** Peak demand is most likely to occur in the afternoons when daylight-responsive control is already dimming the lights.

**Demand response will require a centrally networked system with greater IT security clearance.**

**In locations with high-demand charges, networked lighting controls (using a demand response strategy) can add significant net present value.** Rocky Mountain Institute conducted an analysis for GSA, *Value Potential for Grid-Interactive Efficient Buildings in the GSA Portfolio: A Cost-Benefit Analysis*. This report analyzed multiple building systems in different buildings and locations (rate structures) across the country. Lighting was one of the technologies recommended to be included in each of the technology packages for GEB strategies.

**A GEB strategy can be implemented simply if the lights are controlled by the BAS.** At the Austin Courthouse, if a DR event is activated, the BAS is used manually or automatically to turn off non-essential interior architectural lighting to reduce demand.

**For new construction or major retrofit, plan lighting circuitry or lighting controls to allow for load shedding and demand response options.** The March 2019 post-occupancy evaluation of the Austin U.S. Courthouse found that facility management wanted to participate in a load-shedding program but were unable to do so because the original lighting circuitry was not designed to allow for it. Another GSA facility was not able to take part in a load-shedding program because offices and corridors were frequently circuited together (NIBS, 2019b).

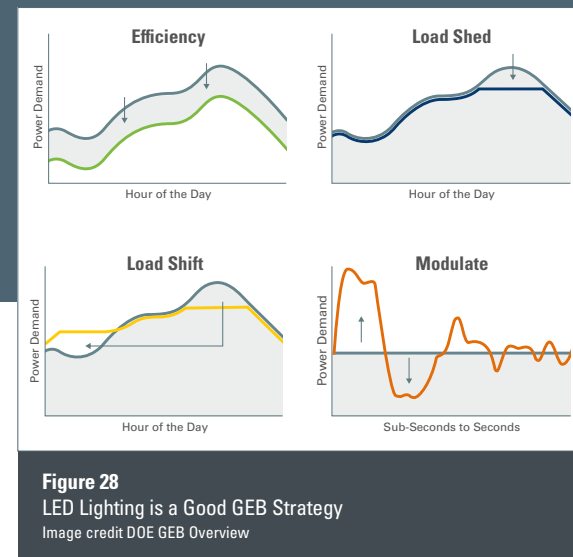

**Ensure networked lighting controls have Automated Demand Response (ADR) 2.0 options and commission the controls for the ADR signal during installation.** OpenADR 2.0 is a standardized demand response protocol that includes pricing and other information. Many utilities can produce an OpenADR 2.0 signal, and many lighting products exist that can receive an OpenADR signal.

**Material cost:** Will vary

**Labor time:** < 2 hours

# Enhanced Performance Capabilities

In addition to HVAC and demand response, control systems can increase facility productivity with features such as diagnostics and monitoring, occupant counting, and asset tracking.

## Color Tuning

Color tuning changes a fixture's light spectrum to change the correlated color temperature (CCT): low CCT (2700 K) is warm, orangish-white, and high CCT (5000–6500 K) is cool, bluish-white. Color tuning can be used to stimulate both visual and physiological responses and may support circadian rhythms. Color tuning requires a control system, and although it may be possible to color tune with stand-alone controls, networked systems will be more successful. Note that color selectable is different from color tunable. Color selectable is where a lighting fixture may have a dip switch or some other means of setting the CCT in the field.

## Scene Control

Scene control allows you to predefine a lighting profile (i.e., bright morning, audio/visual presentation, or general meeting) and illuminate an area based on the lighting needs and activities of the space.

GSA courtrooms and conference rooms require scene controls. The 2021 GSA [U.S. Courts Design Guide Judicial Conference of the United States](#) and GSA's [Region 9 Conference Center Meeting Room Systems Operations](#) outline scene control requirements and configurations for courtrooms and conference/ meeting rooms.

Also, consider scene controls in lobbies, public spaces, and open-plan offices. Scene control is particularly beneficial if the sun or building geometry is an issue. It can accommodate features like shades used on western-facing facades in the late afternoon. Scene controls can be integrated into AV systems, so users can change a scene and operate the AV system in a conference room or lecture hall from the same control device.

When upgrading to LED lighting, include upgrading scene controls in the contract language. Some courthouses have had issues with flicker after upgrading to LED and keeping the same scene controls. Ensure the dimmer used for scene control is compatible with the LED devices. Dimmer incompatibility may be more of an issue with wall-mounted scene controllers.

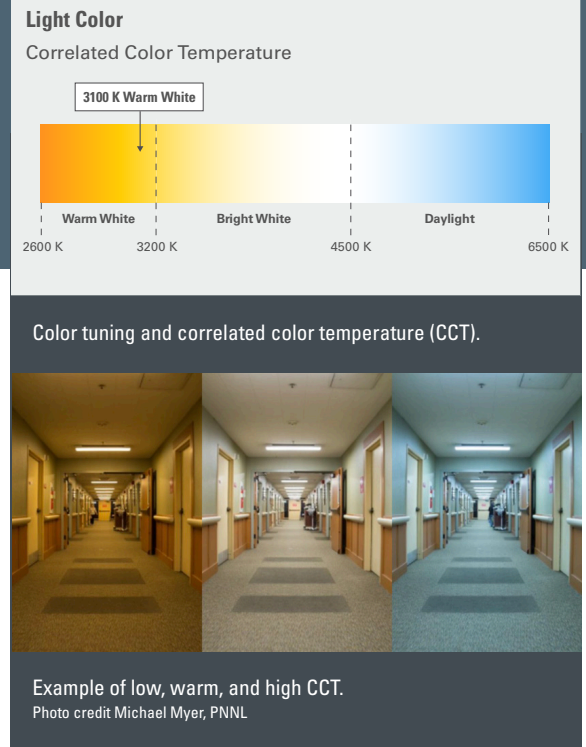



# Enhanced Performance Capabilities

## Energy Measurement and Reporting

Energy data collected from digital drivers (i.e., D4i or ANSI C137.4) can be used to track system performance, optimize system parameters, and secure utility incentives. Granularity and data display vary, which can affect usefulness: utility incentive programs often mandate specific requirements.

## System Diagnostics and Monitoring

Digital drivers can report system diagnostics, which can help service personnel address problems rapidly and reduce costs. Diagnostic capabilities range from simple status alerts to detailed, product-specific maintenance information. On-site investigation to identify and address problems in lighting control systems can be very costly.

## Indoor Positioning

Nodes or sensors communicate with enabled personal devices, such as phones or ID badges, to provide indoor positioning. Combined with mapping applications, this capability can assist in navigating unfamiliar facilities or guiding users through retail or cultural displays. User concerns about privacy should be considered upfront. A local or cloud-based server is required to store data and communicate with other software applications.

## Asset Tracking

A variety of technologies (e.g., sensors, RF tags, and beacons) can identify and locate valuable equipment, minimizing idle, misplaced, or stolen assets. A local or cloud-based server is required to store data and communicate with other software applications.

## Occupant Counting

Advanced occupancy sensors can be used to count the number of occupants in a space. This level of granular data can improve long-term facility planning, emergency intervention, and real-time space allocation. Data capture and display are key to effective utilization of this capability and add to the overall system cost. A local or cloud-based server is required to store data and communicate with other software applications.

# List of Figures and Tables

- Figure 1** Decision Flowchart for Lighting Controls
- Figure 2** Decision Flowchart for Retrofitting Linear LED
- Figure 3** TM-30 Provides Better Color Rendering
- Figure 4** Lower CCT Temperatures are Warmer
- Figure 5** The Driver Determines the Dimming Method
- Figure 6** Distribution Can Be Represented by Beam Angles
- Figure 7** Wired and Wireless Control for Type CTLED
- Figure 8** Power-over-Ethernet Network
- Figure 9** Emergency Power Configurations for TLEDs
- Figure 10** Embedded Sensors in an LLLC System Capture Occupancy Flow and Presence
- Figure 11** Design Lighting Zones by Fixture Type, Application, and Location
- Figure 12** Lighting Controls Configurations
- Figure 13** Wired and Wireless Stand-Alone Control Systems
- Figure 14** Room-Based Control System
- Figure 15** Centrally Networked Control System
- Figure 16** LLLC Systems Embed Sensors in Individual Fixtures
- Figure 17** Sensors are Mounted External to Luminaires in Zone-Based Control
- Figure 18** System Architecture with Wiring Controls
- Figure 19** Digital Control is Less Expensive for Multiple Lights and Zones
- Figure 20** Configuration for 0–10V or DALI-2 LED Drivers
- Figure 21** Reflected Ceiling Plan of an Open Office
- Figure 22** Retro- and Re-Commissioning Steps
- Figure 23** Diminishing Returns for Combined Energy Savings
- Figure 24** Perceived Light Output for 0–10V and DALI-2
- Figure 25** Daylight-Responsive Control Zones
- Figure 26** Task Tuning Can Save Energy and Improve Satisfaction
- Figure 27** Integrating Lighting Sensors with HVAC Can Improve ROI by 30%
- Figure 28** LED Lighting is a Good GEB Strategy
- Table 1** Average LED and Lighting Controls Rebates in North America
- Table 2** 5,000 ft<sup>2</sup> Life-Cycle Cost Effectiveness for Linear LED Lighting Systems and Controls
- Table 3** 50,000 ft<sup>2</sup> Life-Cycle Cost Effectiveness for Controls
- Table 4** DesignLights Consortium v5.1 Requirements
- Table 5** Emergency Lighting Power Methods
- Table 6** Nighttime Setbacks: ANSI/ASHRAE/IES Standard 90.1
- Table 7** Backlight-Uplight-Glare (BUG) Guidelines
- Table 8** ASHRAE/IES Minimum Control Requirements by Space Type
- Table 9** Stand-Alone vs. Room-Based vs. Centrally Networked
- Table 10** Luminaire Performance Diagnostics
- Table 11** Wired vs. Wireless Control Features
- Table 12** Analog vs. Digital Communication Protocols
- Table 13** Control Strategies and Addressability Needs
- Table 14** DALI-1 vs. DALI-2
- Table 15** Lighting Control Energy-Savings Strategies
- Table 16** Energy Savings for Individual/Combined Strategies
- Table 17** Range of Savings for Different Spaces from FEMP
- Table 18** Occupancy Detection Methods
- Table 19** Types of Occupancy Detection Sensors and Where They Are Recommended
- Table 20** Dimming Enables Other Control Capabilities

# References

- ASHRAE. *ANSI/ASHRAE/IES Standard 90.1 – Energy Standard for Buildings Except Low-Rise Residential Buildings*. October 2019.
- DesignLights Consortium (DLC). “Solid-State Lighting Technical Requirements V5.1.” July 2020.
- DOE. “FEMP U.S. Department of Energy Headquarters Lighting Retrofit.” February 2018.
- DOE. “FEMP Purchasing Energy-Efficient Commercial and Industrial LED Luminaires.” June 2021.
- DOE. *FEMP Wireless Occupancy Sensors for Lighting Controls: An Applications Guide for Federal Facility Managers*. January 2019.
- EIA. “CBECS 2012: Trends in Lighting in Commercial Buildings.” May 2017.
- GSA. GPG-002, “Occupant Responsive Lighting.” September 2012.
- GSA. GPG-015, “Integrated Daylighting Systems.” July 2014.
- GSA. GPG-022, “Wireless Advanced Lighting Controls.” May 2015.
- GSA. GPG-024, “LED Fixtures with Integrated Advanced Lighting Controls.” August 2015.
- GSA. GPG-026, “LED Downlight Lamps for CFL Fixtures.” April 2016.
- GSA. GPG-030, “TLED Lighting Retrofits with Dedicated Drivers.” September 2016.
- GSA. GPG-037, “Advanced Lighting Controls and LED.” November 2018.
- GSA. *U.S. Courts Design Guide Judicial Conference of the United States*. Revised March 2021.
- GSA. *Building Technologies Technical Reference Guide*. June 2021.
- GSA. *P100: Facilities Standards for the Public Buildings Service*. October 2021 with 2022 Addendum.
- GSA. *Conference Center Meeting Room Systems Operations*. Region 9, September 2020.
- GSA. “Federal Highway Administration and Department of Veterans Affairs Lighting Interventions.” Last Reviewed April 18, 2022.
- LBNL. *Improving Energy Efficiency through Commissioning: Getting Started with Commissioning, Monitoring, and Maintaining Performance*. October 2013.
- Lighting Research Center at Rensselaer Polytechnic Institute. “Methodology Report: Lighting Guidelines Field Demonstrations. Department of Veteran Affairs Medical Center, White River Junction, Vermont. Federal Highway Administration Turner-Fairbank Highway Research Center, McLean, Virginia.” Submitted November 2016, Revised July 2017.
- Newsham, G., Macinini S., & Marchand, R., *Detection and Acceptance of Demand-Responsive Lighting in Offices with and without Daylight*. *Leukos*, Issue 4 (January 2008).
- PNNL. *Selecting Lighting Controls Systems to Satisfy Project Objectives*. Updated November 2022.
- PNNL. *Interior Lighting Campaign: 2015–2019 Results*. September 2019.
- PNNL. *Lighting System Integration with HVAC and Plug Loads: Tinker Air Force Base*. January 2021.
- PNNL. “Connected Lighting Systems in Smart Buildings: Findings and Lessons Learned from the U.S. Department of Energy Integrated Lighting Campaign and Multiple Field Evaluations.” 2022.
- Williams, A., Atkinson, B., Garbesi, K., Page, E., & Rubinstien, F., “Lighting Controls in Commercial Buildings.” *Leukos* 8, Issue 3 (January 2012).



Green Proving Ground

U.S. General Services Administration  
Pacific Northwest National Laboratory

Visit: [www.gsa.gov/gpg](http://www.gsa.gov/gpg)

Email: [gpg@gsa.gov](mailto:gpg@gsa.gov)